

CKCL22X7R2A222M085AK

TDK Item Description : CKCL22X7R2A222MT***S



Application & Main Feature

Commercial Grade (2 in 1 Array)

Series

CKCL22(2012) [EIA CC0805]

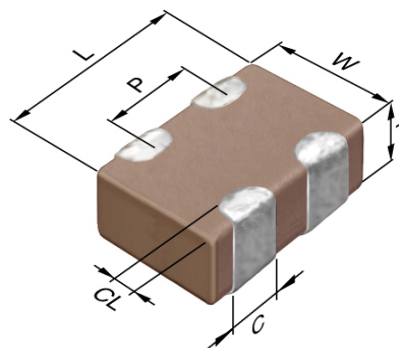

Dimensions

L 2.00mm +/-0.15mm
 W 1.25mm +/-0.15mm
 T 0.85mm +/-0.15mm
 C 0.45mm Nom.
 P 1.00mm Nom.

Temperature Characteristic

X7R (-55 to 125 degC +/-15%)

Rated Voltage

2A (100Vdc)

Capacitance

2.2nF

Capacitance Tolerance

M (+/-20%)

Dissipation Factor

3% Max.

Insulation Resistance

10Gohm Min.

AEC-Q200

Not Applicable

|Z|, ESR vs. Freq. Characteristics

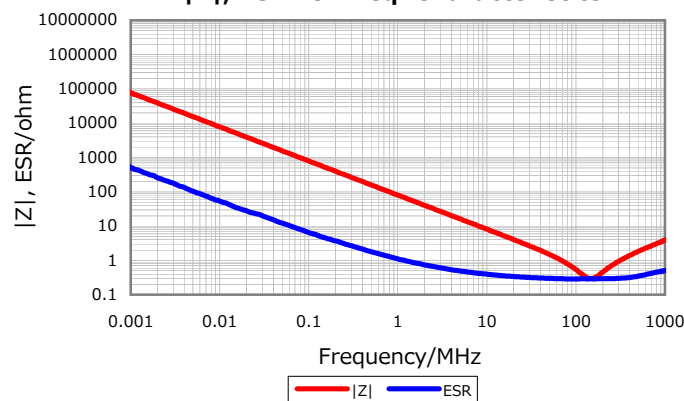

Cap. vs. Freq. Characteristic

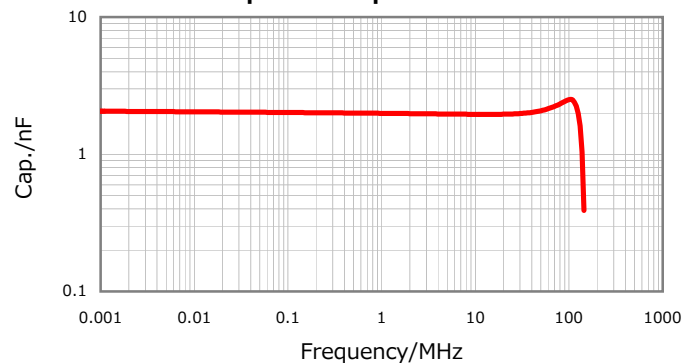

DC Bias Characteristic

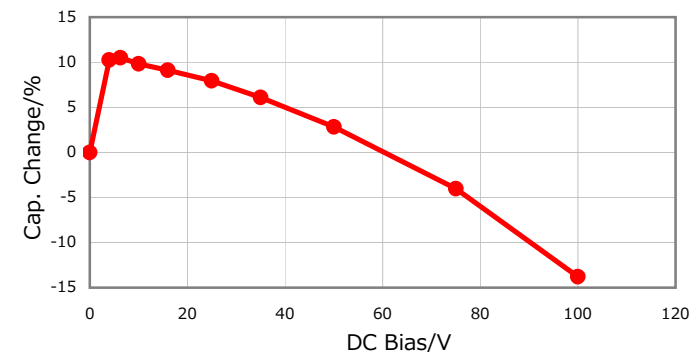

Temperature Characteristics

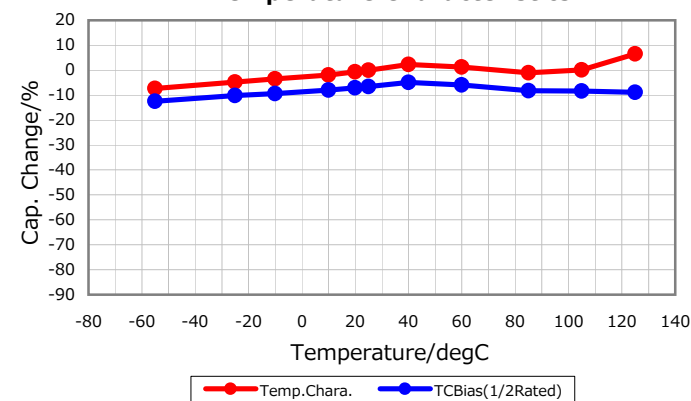

Ripple Temperature Rise Characteristics

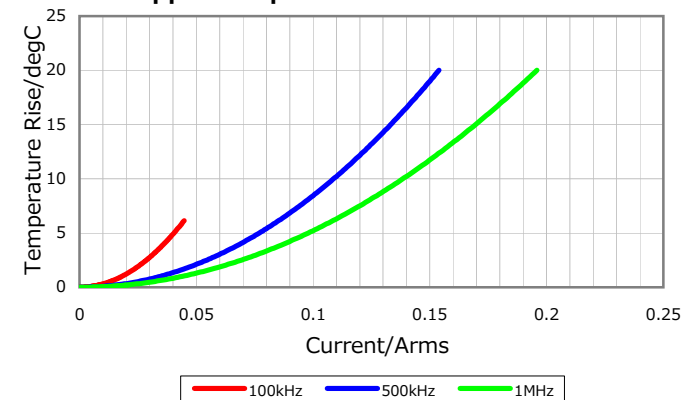

Characterization Sheet (Multilayer Ceramic Chip Capacitors)



All specifications are subject to change without notice.

January 4, 2016