

DETAILS

Product Number	CA12411_STRADA-SQ-A-T
Family	Strada
Type	Assembly
Color	clear
Diameter	25 + 25 mm
Height	9,15 mm
Style	square
Optic Material	PMMA
Holder Material	
Fastening	screw, tape
Status	production ready
ROHS Compliant	Yes
Date Updated	26/08/2014

OPTICAL PROPERTIES

LED	Viewing Angle	Light Beam	Efficiency	cd/lm	Connector
XM-L	Asymmetric deg	Streetligh...	93 %	0.510	-
XM-L2	asymmetric deg	Streetligh...	94 %	0.700	-
XHP50	Asymmetric deg	Streetligh...	94 %	0.590	-
LUXEON M/MX	Asymmetric deg	Streetligh...	93 %	0.410	-
LUXEON MZ	asymmetric deg	Streetligh...	93 %	0.730	-
LUXEON XR-M linear 1x3, 1x4, 1x5	Asymmetric deg	Streetligh...	94 %	0.540	-
NS9x383	Asymmetric deg	Streetligh...	93 %	0.690	-
OLP-5065F6L-06A	Asymmetric deg	Streetligh...	93 %	0.650	-
OLP-5065F6L-06A	Asymmetric deg	Streetligh...	93 %	0.650	-
Duris S10	Asymmetric deg	Streetligh...	93 %	0.580	-



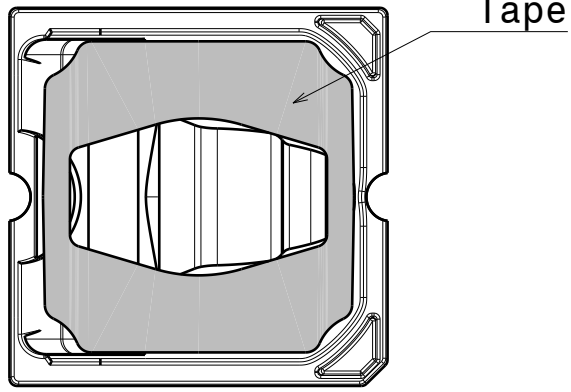

Bottom view

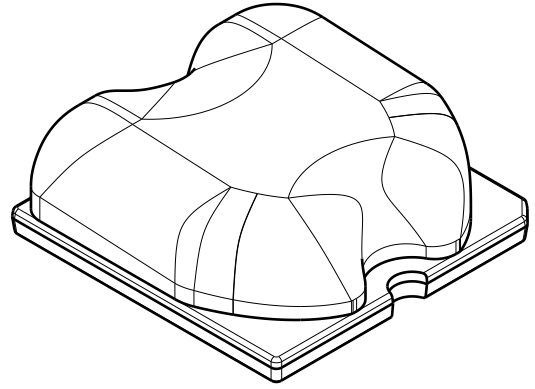

Isometric view

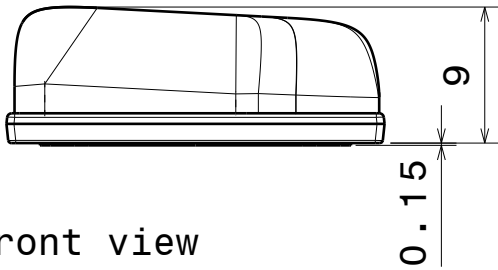

Front view

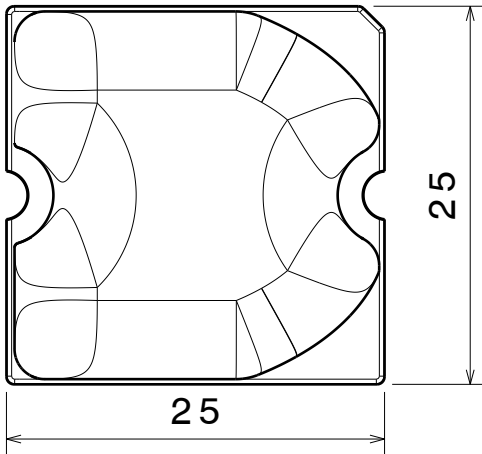

Top view

Tolerances if not otherwise shown:
According to DIN ISO 2768-1
Linear measures:
Up to 30mm class M, otherwise class C.

According to DIN ISO 2768-2
Form and position:
class L

Control for SPC marked dimensions.

This drawing is our property.
It can't be reproduced
or communicated without
our written agreement.

LEDIL LediL Oy
Salorankatu 10
FIN 24240 SALO
Finland

DRAWING TITLE Mechanical drawing

DRAWN BY as
DATE 25.9.2012

STRADA-SQ-A-T

CHECKED BY VS
DATE -

SIZE A4 PART NUMBER REV 001

DESIGNED BY -
DATE -

SCALE 2:1 WEIGHT 4,97 g SHEET 1/1

Luminaire: Ledil oy C12410_STRADA-SQ-A-T-XM-L LOR=88%
Lamps: 1 x Cree XM-L 250mA 95lm

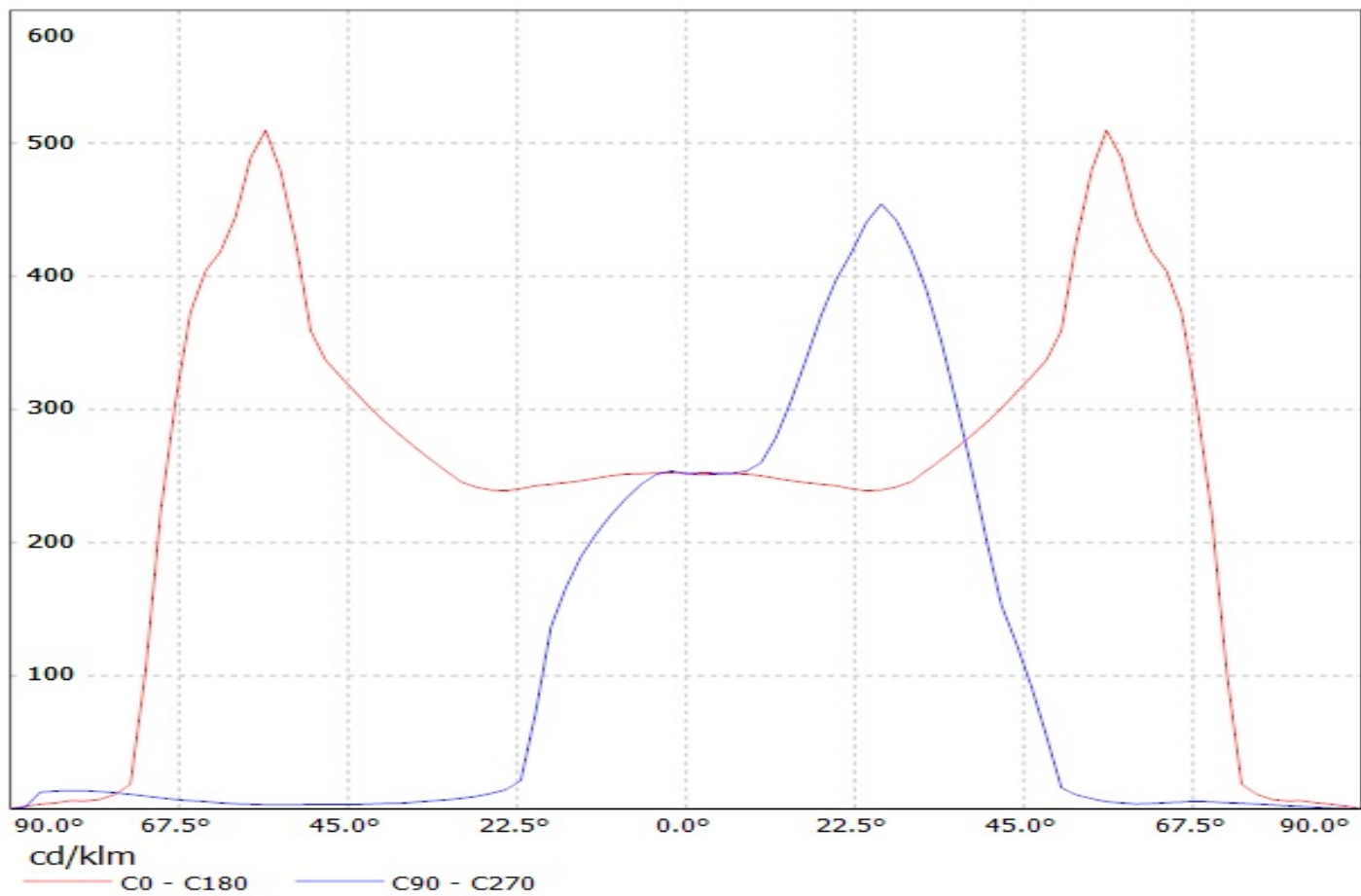

Luminaire: LEDil Oy CA12411_STRADA-SQ-A-T_(XM-L2) Efficiency=94%
Lamps: 1 x Cree XM-L2 (XMLBWT-0-7B4-T30-0L-0001) 91lm @ 250mA CCT=3200K P=2.8W I=250mA

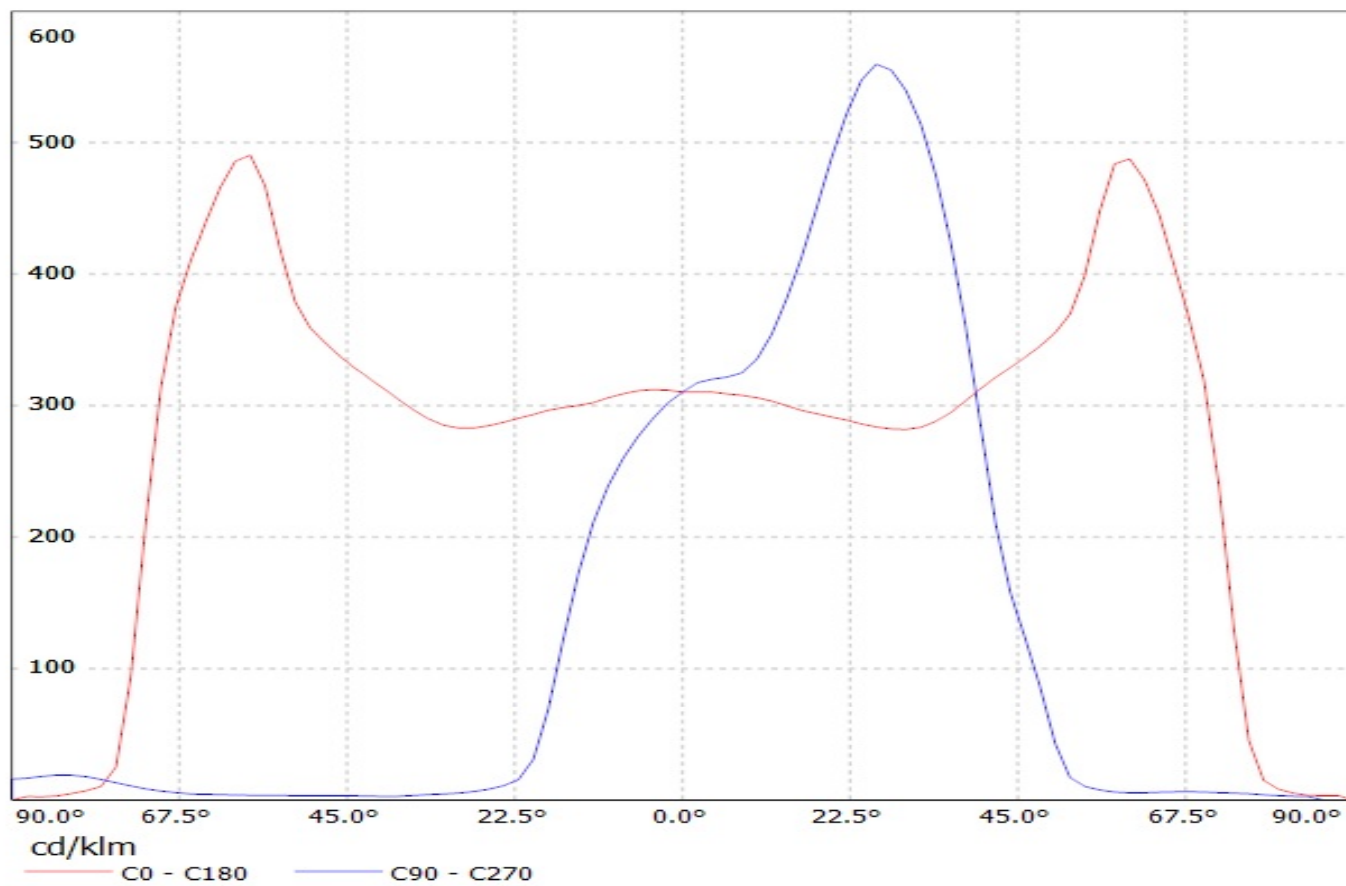

Luminaire: LEDiL Oy CA12411_STRADA-SQ-A-T_(Cree_XHP50_cool_white)
Lamps: 1 x Cree_XHP50_cool_white_243.798lm@250mA_P=1.42945W_I=0.2499A

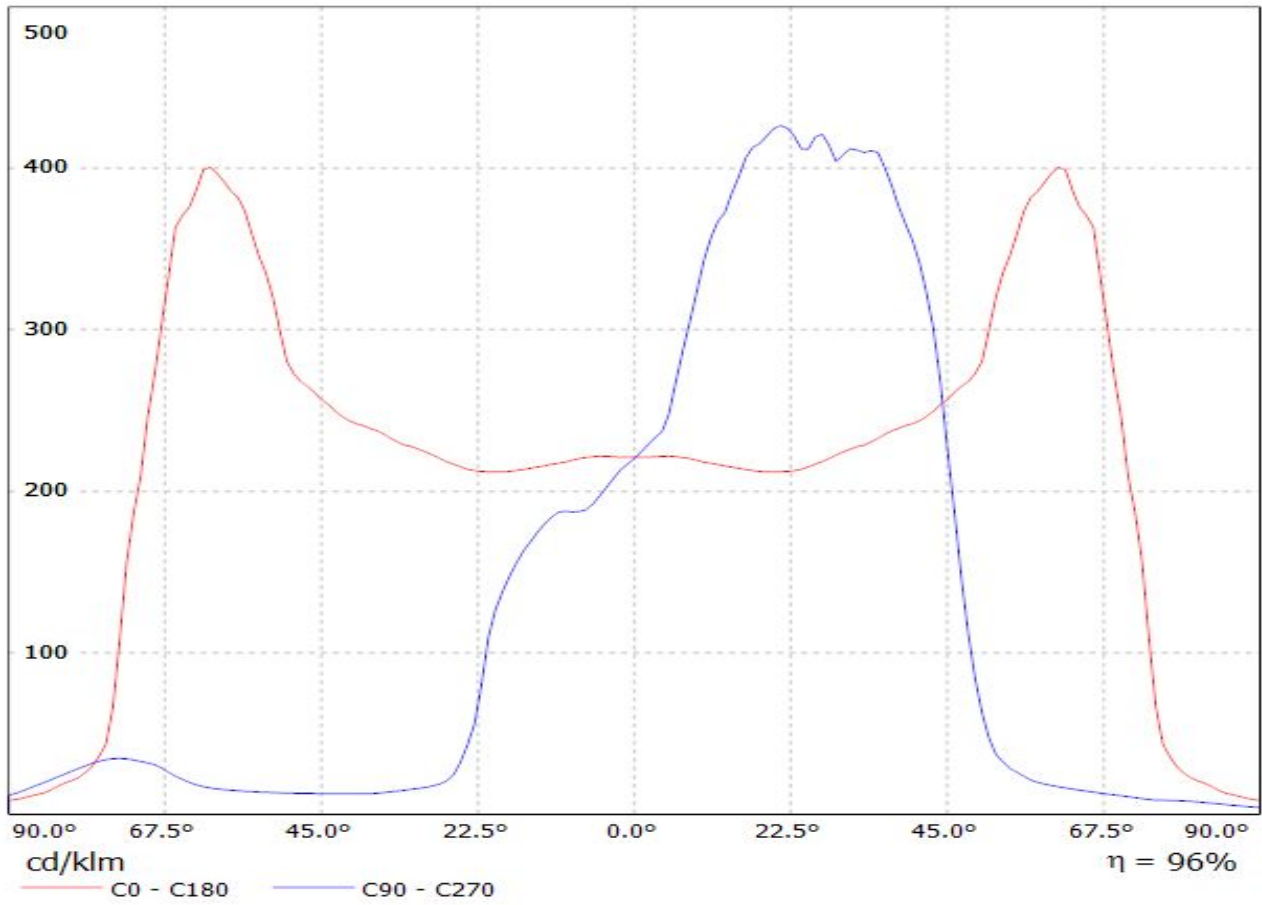

Luminaire: LEDiL Oy CA12411_STRADA-SQ-A-T_(Luxeon_MZ) Eff: 93%
Lamps: 1 x LUXEON-MZ_263.325lm@250mA_P=2.7414W_I=249.9mA

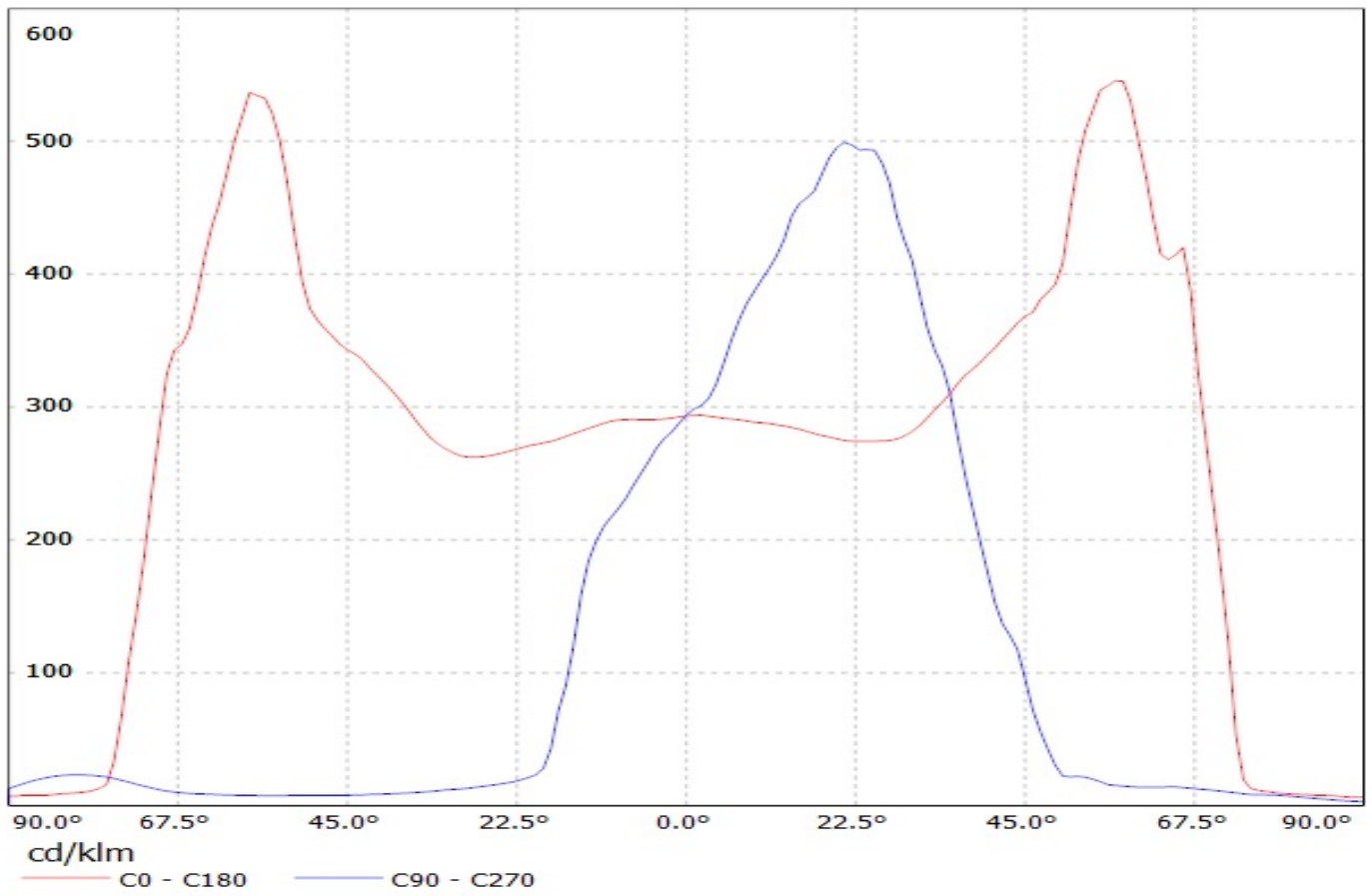

Luminaire: Ledil CA12411_STRADA-SQ-A-T_(LUXEON_XR-M_Linear_1x4)
Lamps: 1 x Lumiled_LUXEON_XR-M_Linear_1x4_1798.32lm@250mA_P=11.005W_I=0.25A

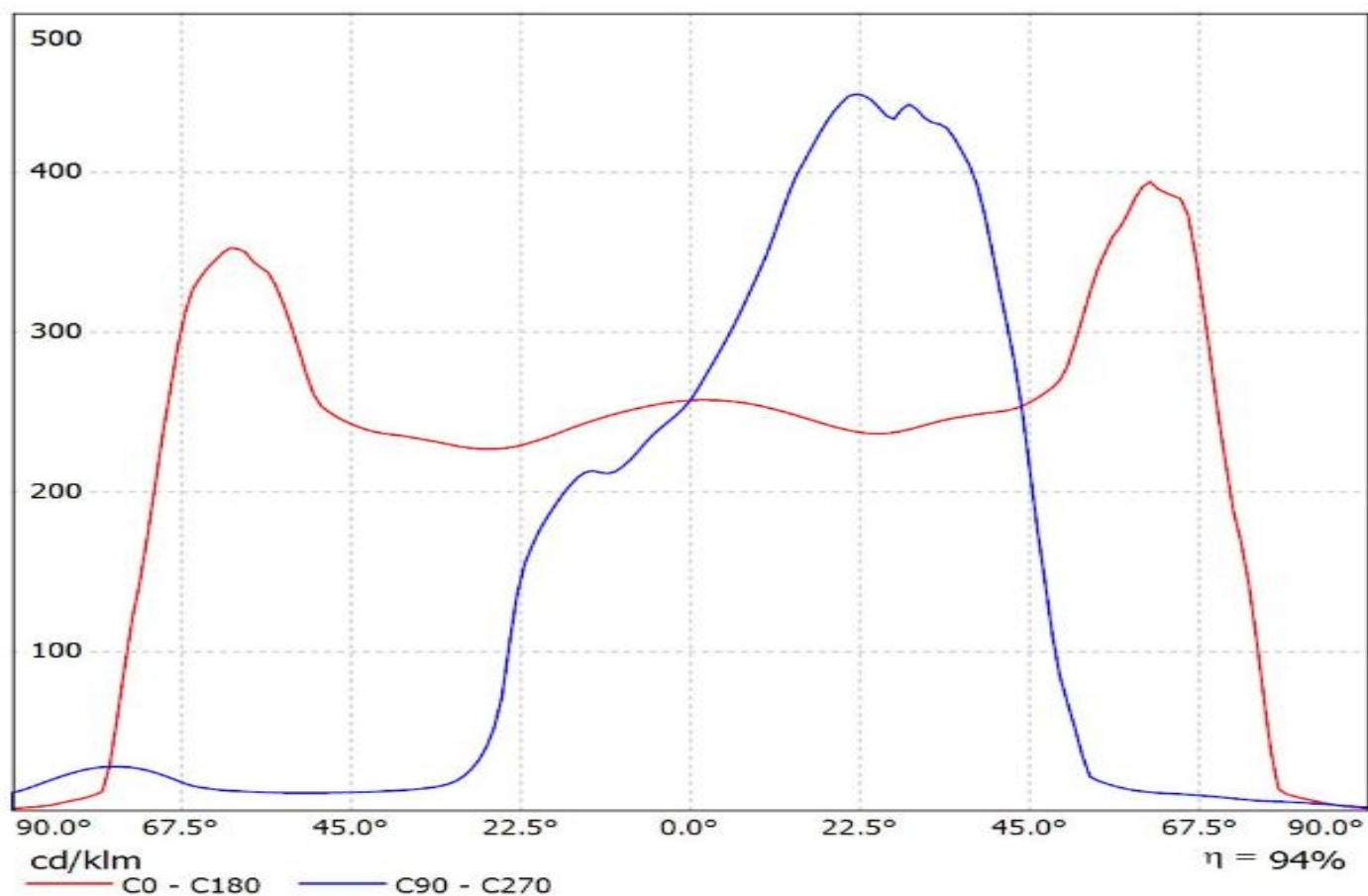

Luminaire: LEDiL Oy CA12411_STRADA-SQ-A-T_(NS9x383) Eff. 93,1%
Lamps: 1 x Nichia NS9x383 (105lm@250mA)

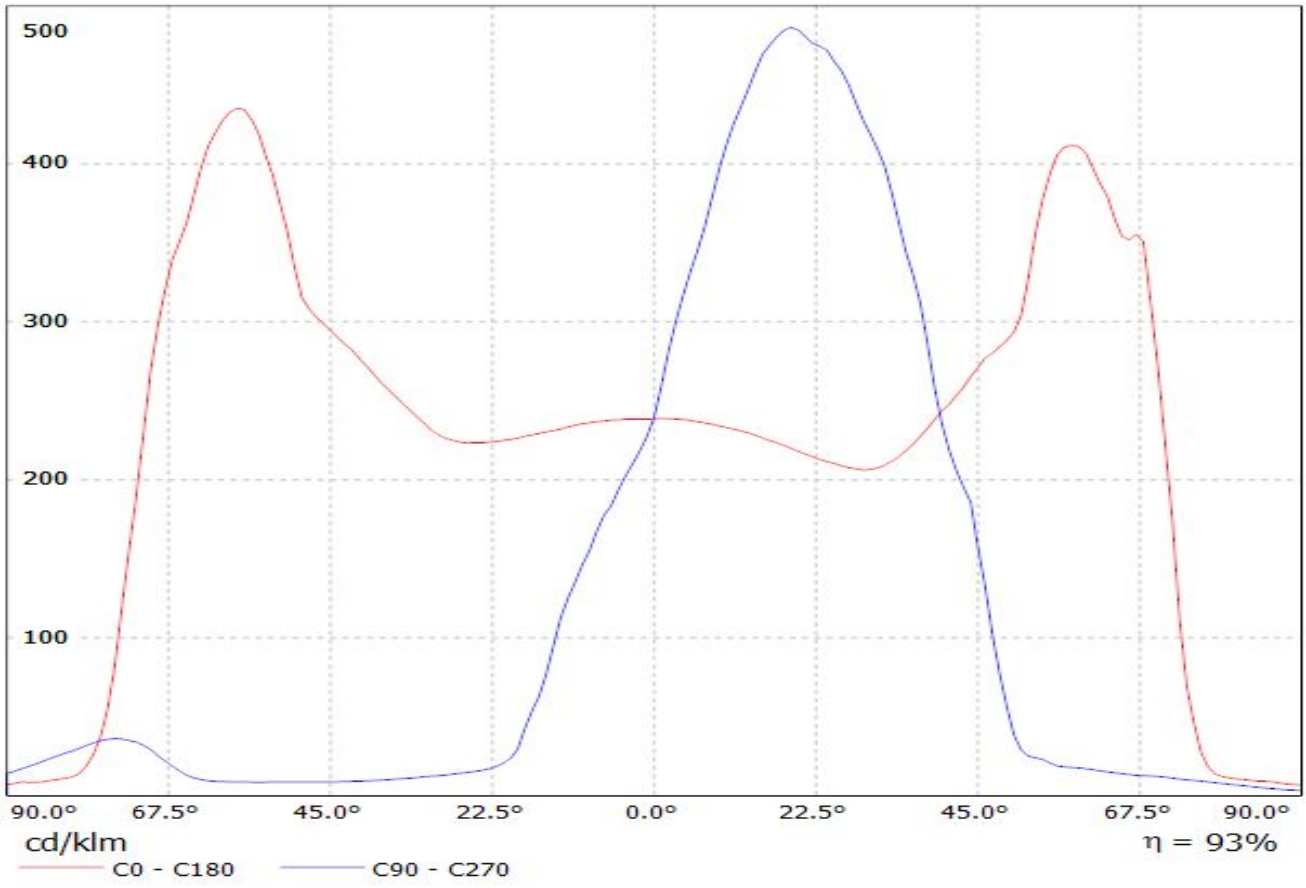

Luminaire: LEDiL Oy CA12411_STRADA-SQ-A-T_(OLP-5065F6L-06A)

Lamps: 1 x OPTOGAN_(OLP-5065F6L-06A-80-D05O0) 106.528lm@250mA CCT=5000K P=0.777664W I=249.9mA

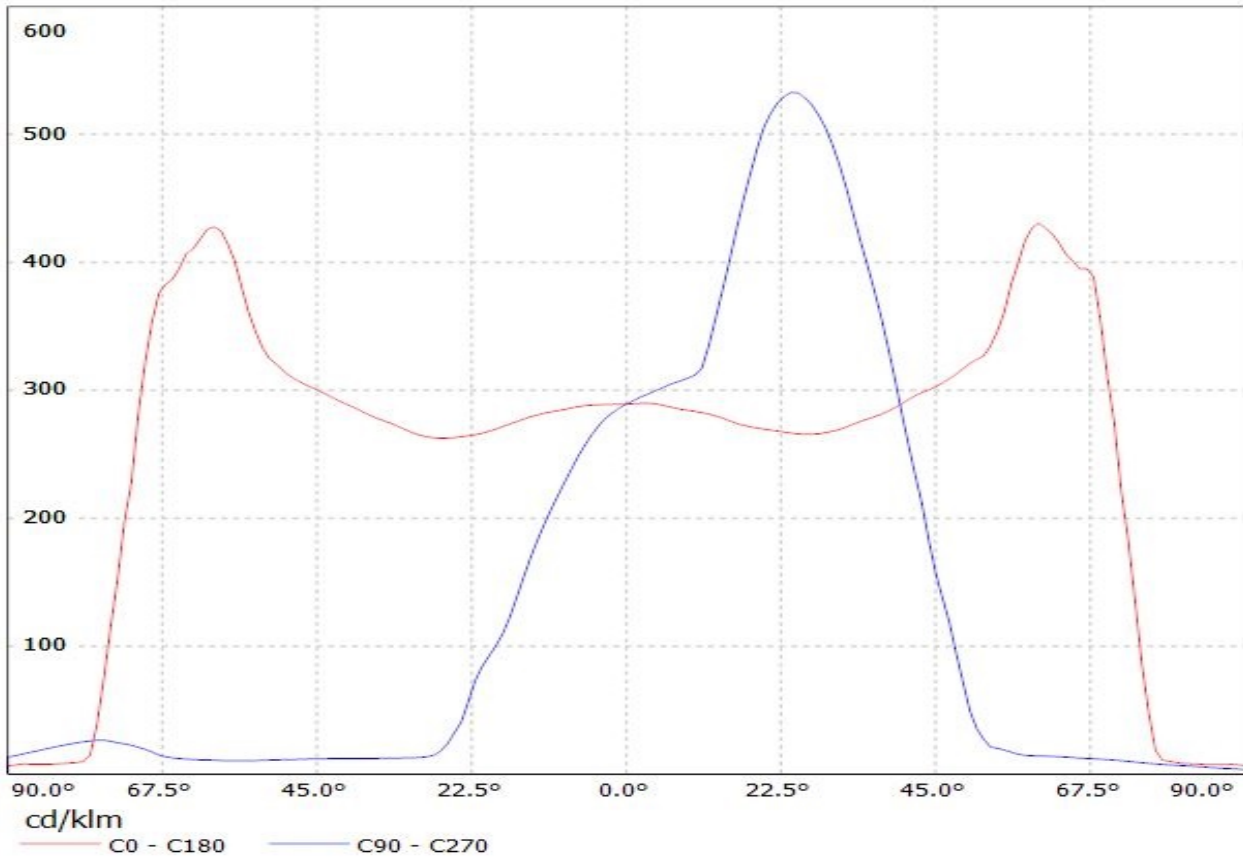

Luminaire: LEDiL Oy CA13119_STRADA-SQ-A-T_(OLP-5065F6L-06A) Eff.93%
Lamps: 1 x OPTOGAN_(OLP-5065F6L-06A-80-D0500) 106.528lm@250mA CCT=5000K P=0.777664W I=249.9mA

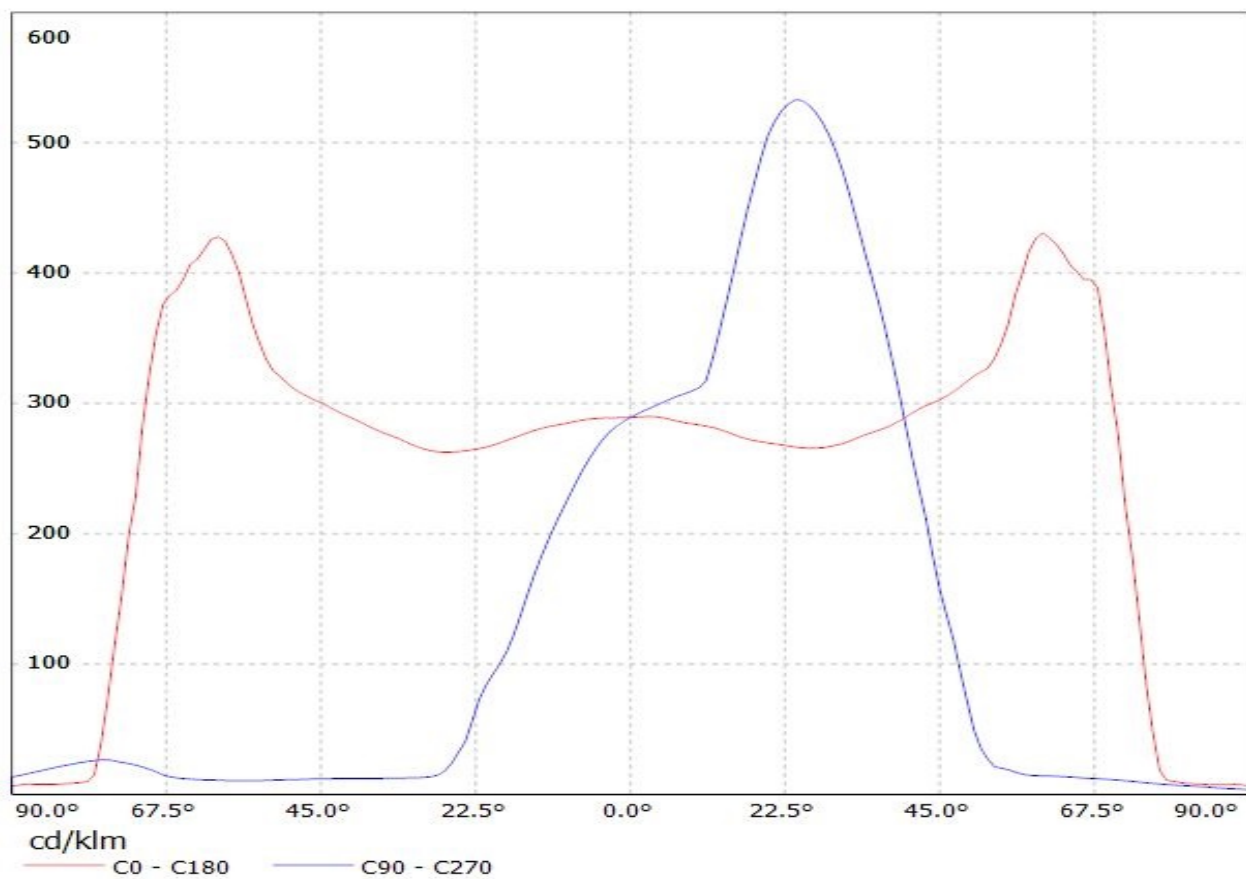

Luminaire: Ledil CA12411_STRADA-SQ-A-T_(Duris_S10)

Lamps: 1 x Osram_Duris_S10_(GW-P7LP32.EM)_992.375lm@250mA_P=9.2362W_I=0.25A

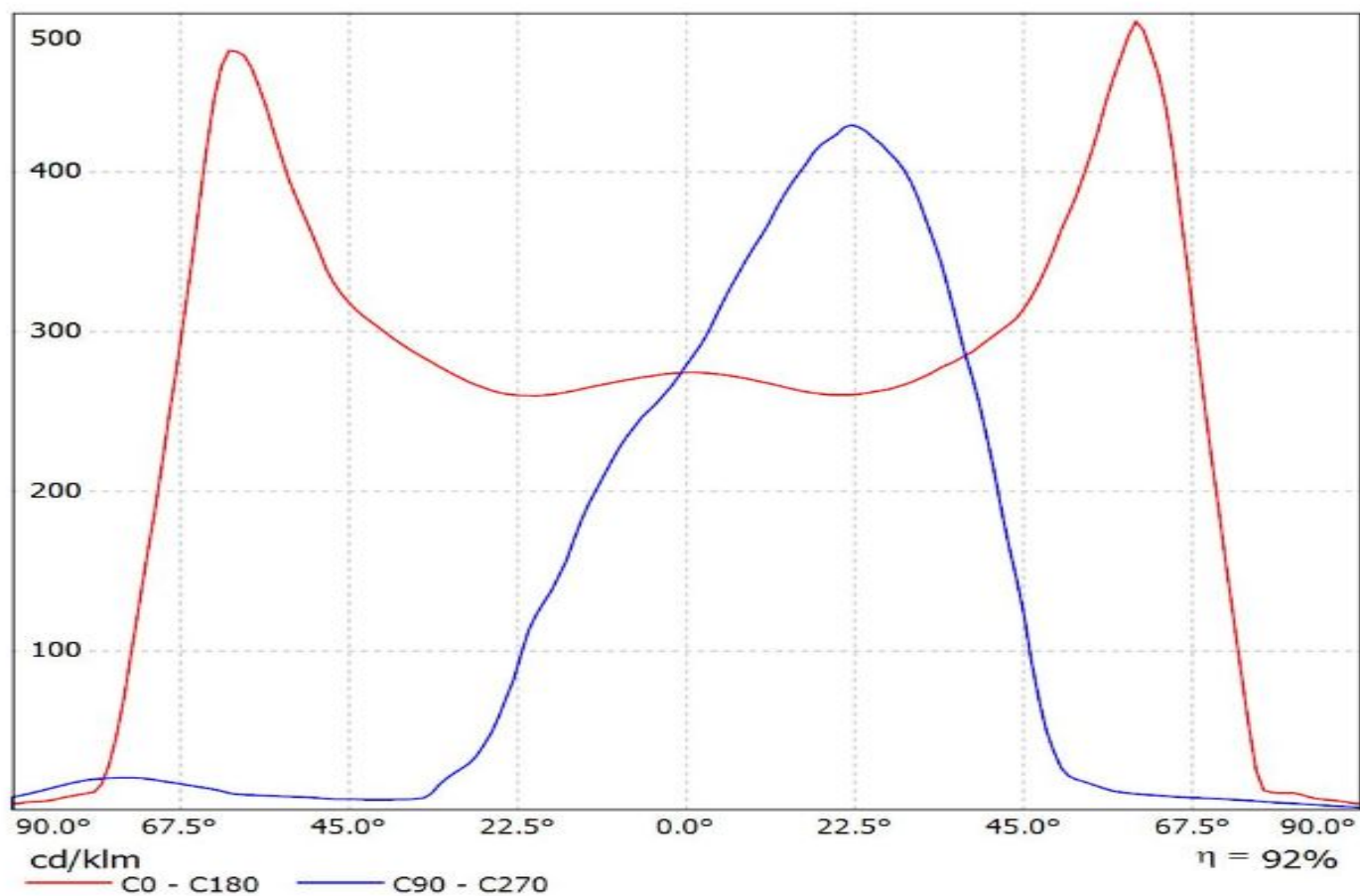

Luminaire: Ledil oy C12411_STRADA-SQ-A-T-XM-L LOR=88%
Lamps: 1 x Cree XM-L 250mA 95lm

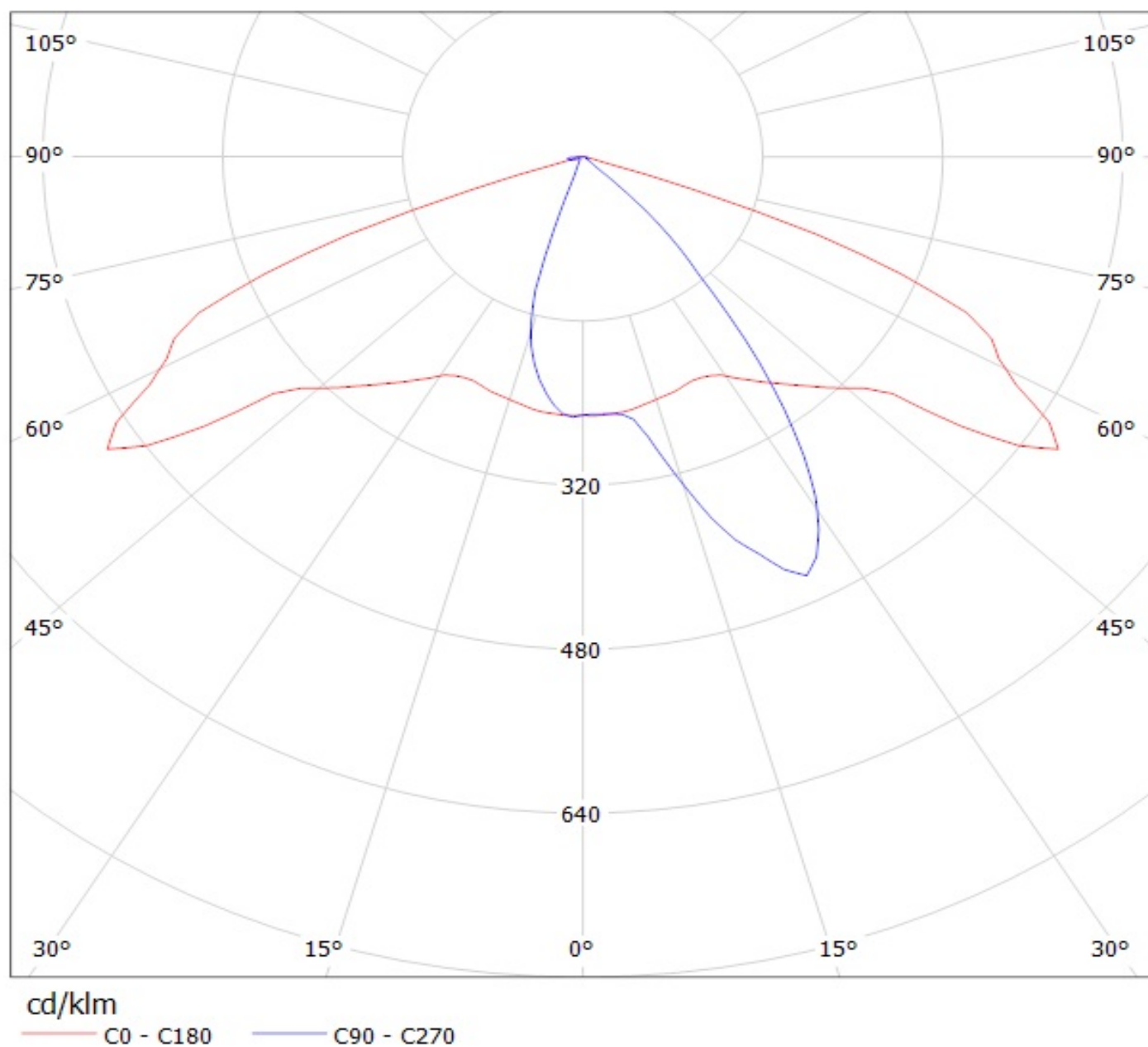

Luminaire: LEDil Oy CA12411_STRADA-SQ-A-T_(XM-L2) Efficiency=94%

Lamps: 1 x Cree XM-L2 (XMLBWT-0-7B4-T30-0L-0001) 91lm @ 250mA CCT=3200K P=2.8W I=250mA

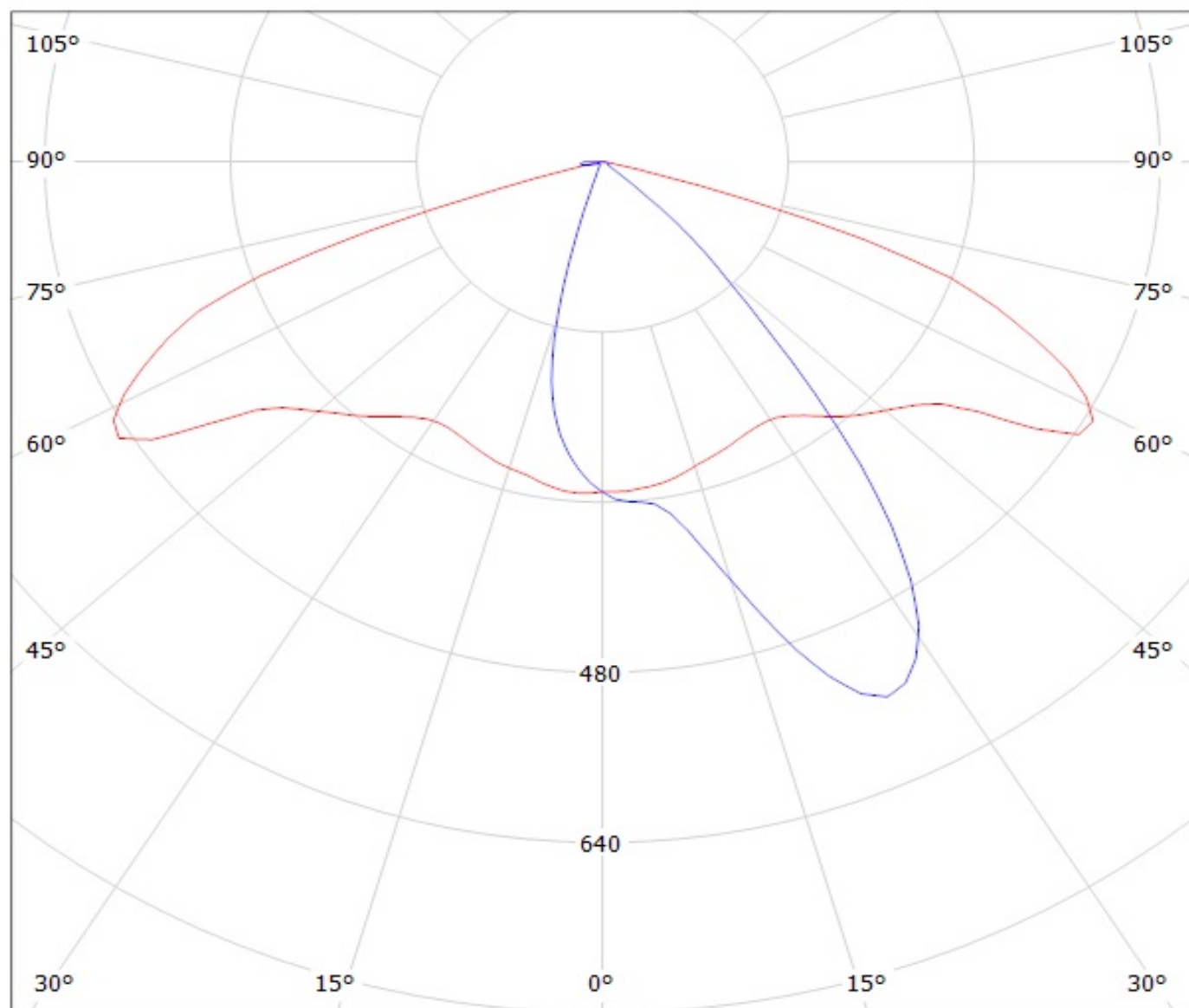

cd/klm

— C0 - C180

— C90 - C270

Luminaire: LEDiL Oy CA12411_STRADA-SQ-A-T_(Cree_XHP50_cool_white)
Lamps: 1 x Cree_XHP50_cool_white_243.798lm@250mA_P=1.42945W_I=0.2499A

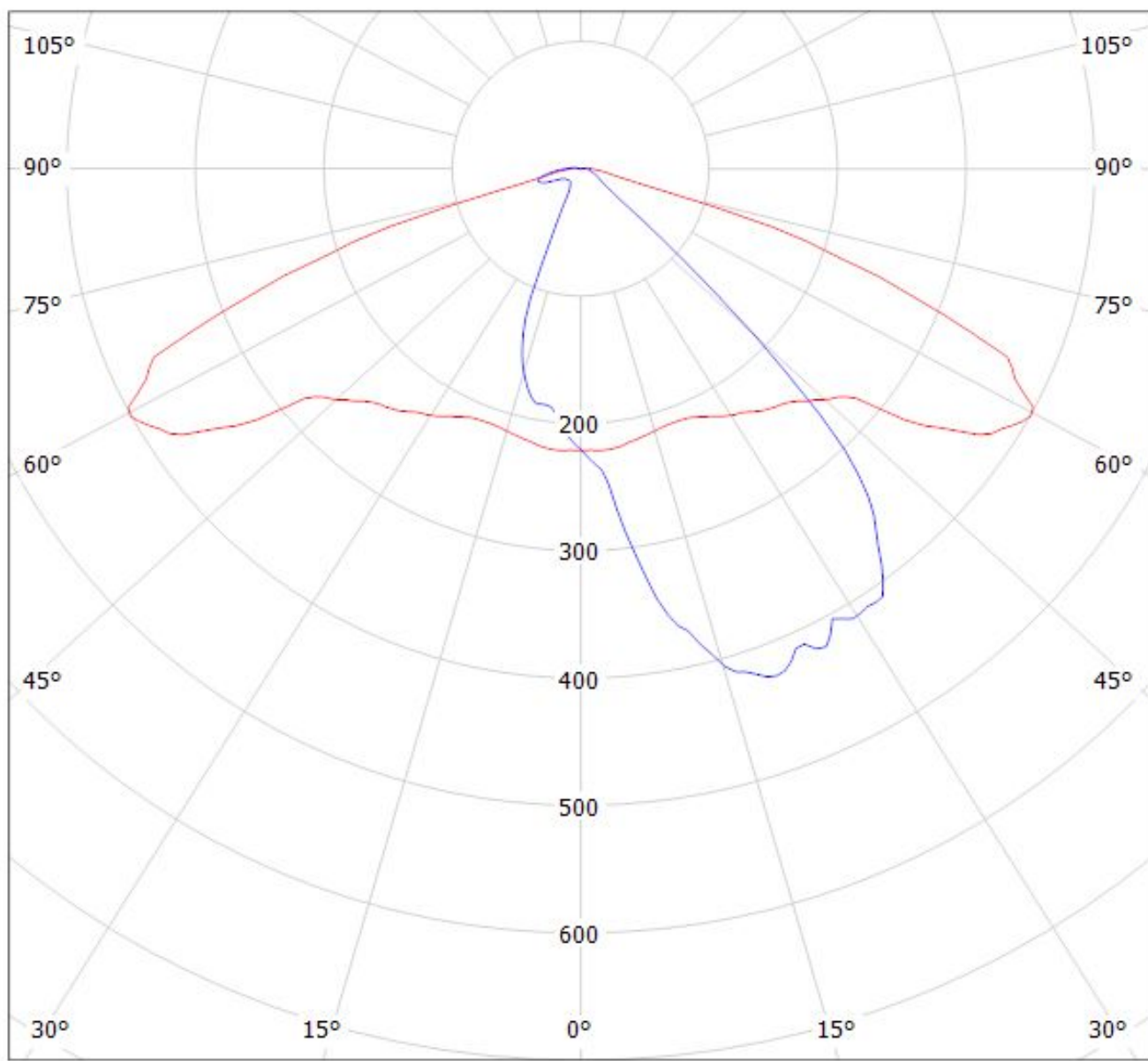

cd/klm

— C0 - C180 — C90 - C270

$\eta = 96\%$

Luminaire: Ledil Oy C12411_STRADA-SQ-A-T (Luxeon M) Efficiency=93%
Lamps: 1 x Luxeon M 362lm @ 250mA

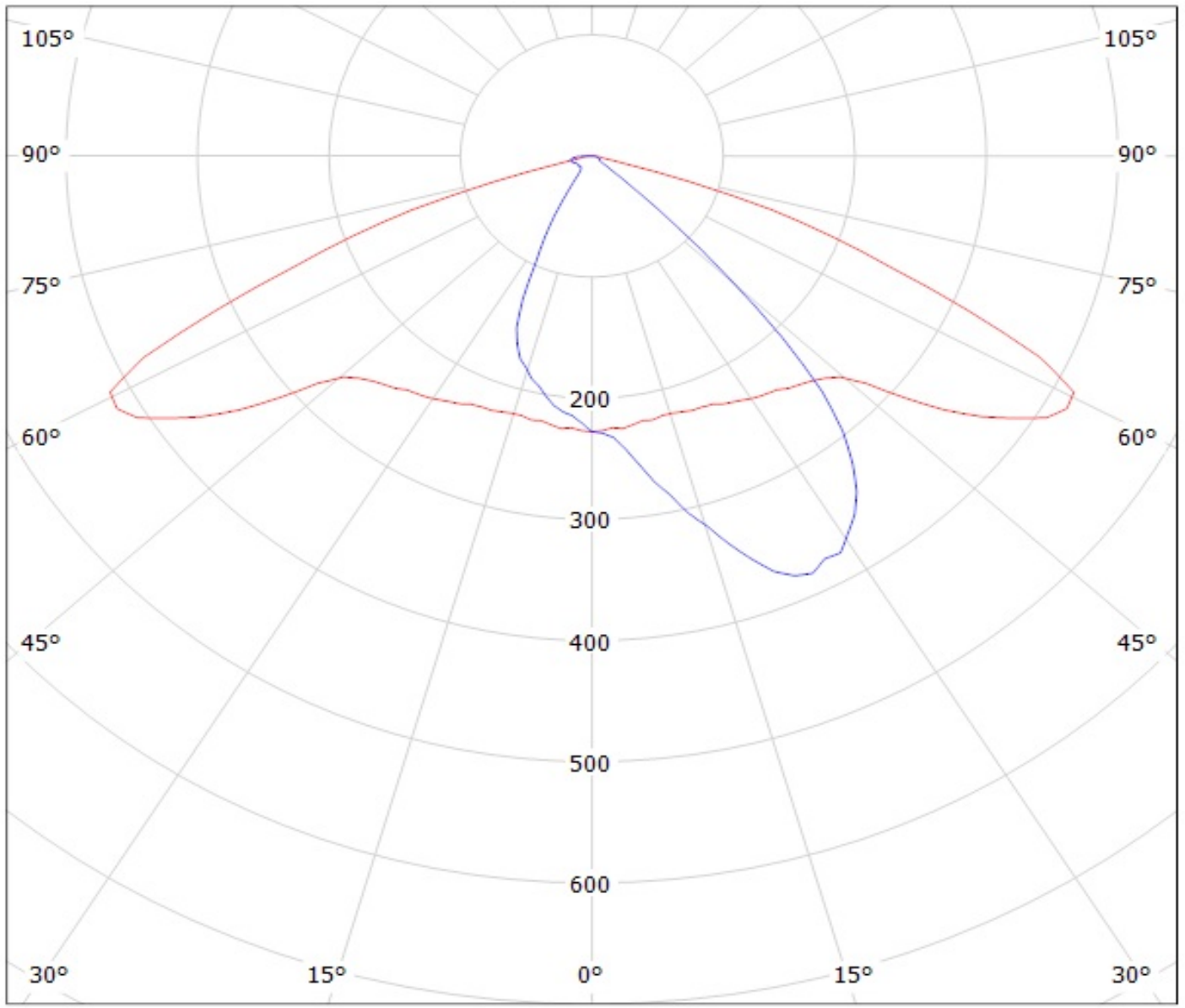

cd/klm

— C0 - C180 — C90 - C270

Luminaire: LEDiL Oy CA12411_STRADA-SQ-A-T_(Luxeon_MZ) Eff: 93%
Lamps: 1 x LUXEON-MZ_263.325lm@250mA_P=2.7414W_I=249.9mA

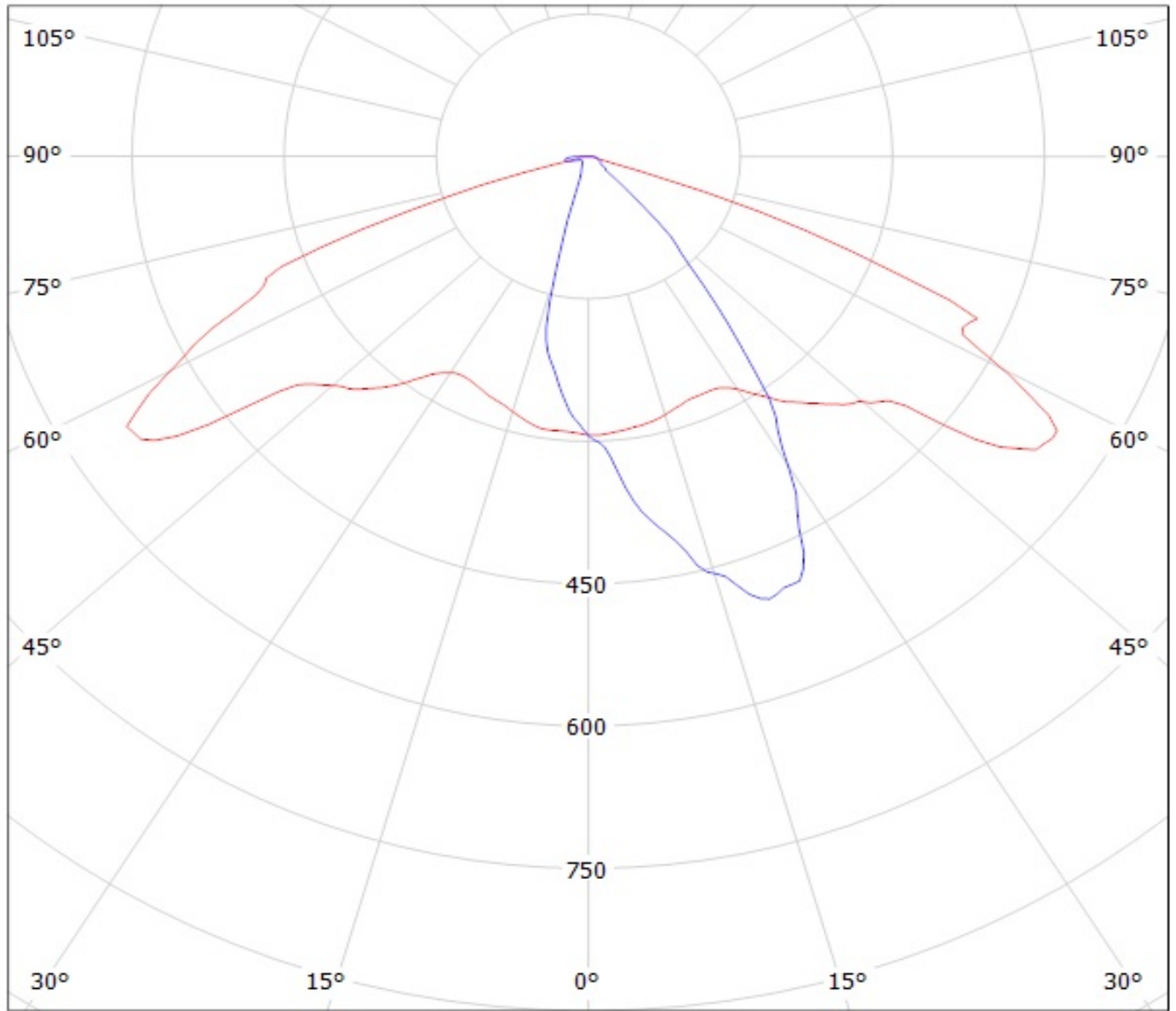

cd/klm

— C0 - C180 — C90 - C270

Luminaire: Ledil CA12411_STRADA-SQ-A-T_(LUXEON_XR-M_Linear_1x4)

Lamps: 1 x Lumiled_LUXEON_XR-M_Linear_1x4_1798.32lm@250mA_P=11.005W_I=0.25A

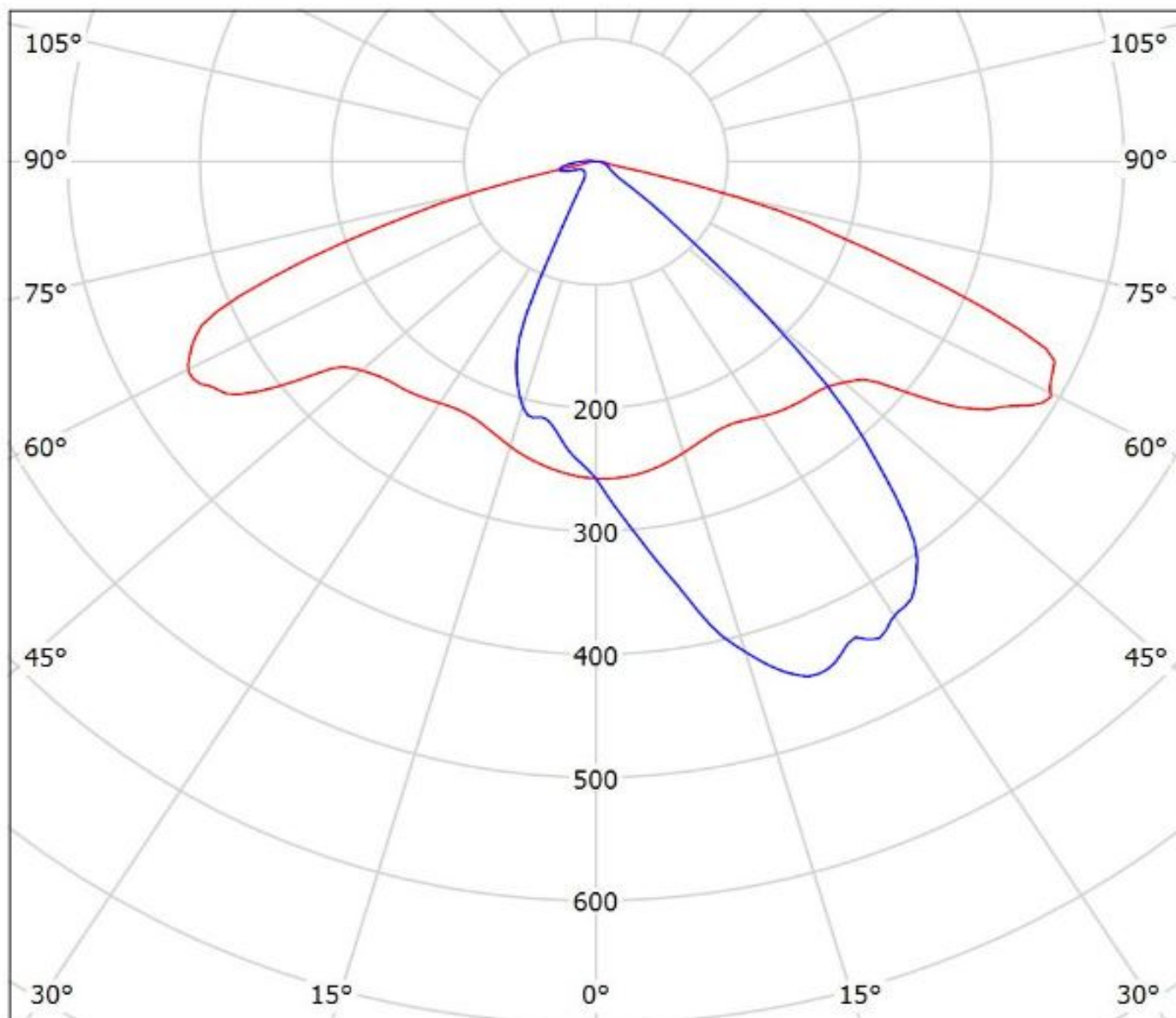

cd/klm

— C0 - C180

— C90 - C270

$\eta = 94\%$

Luminaire: LEDiL Oy CA12411_STRADA-SQ-A-T_(NS9x383) Eff. 93,1%
Lamps: 1 x Nichia NS9x383 (105lm@250mA)

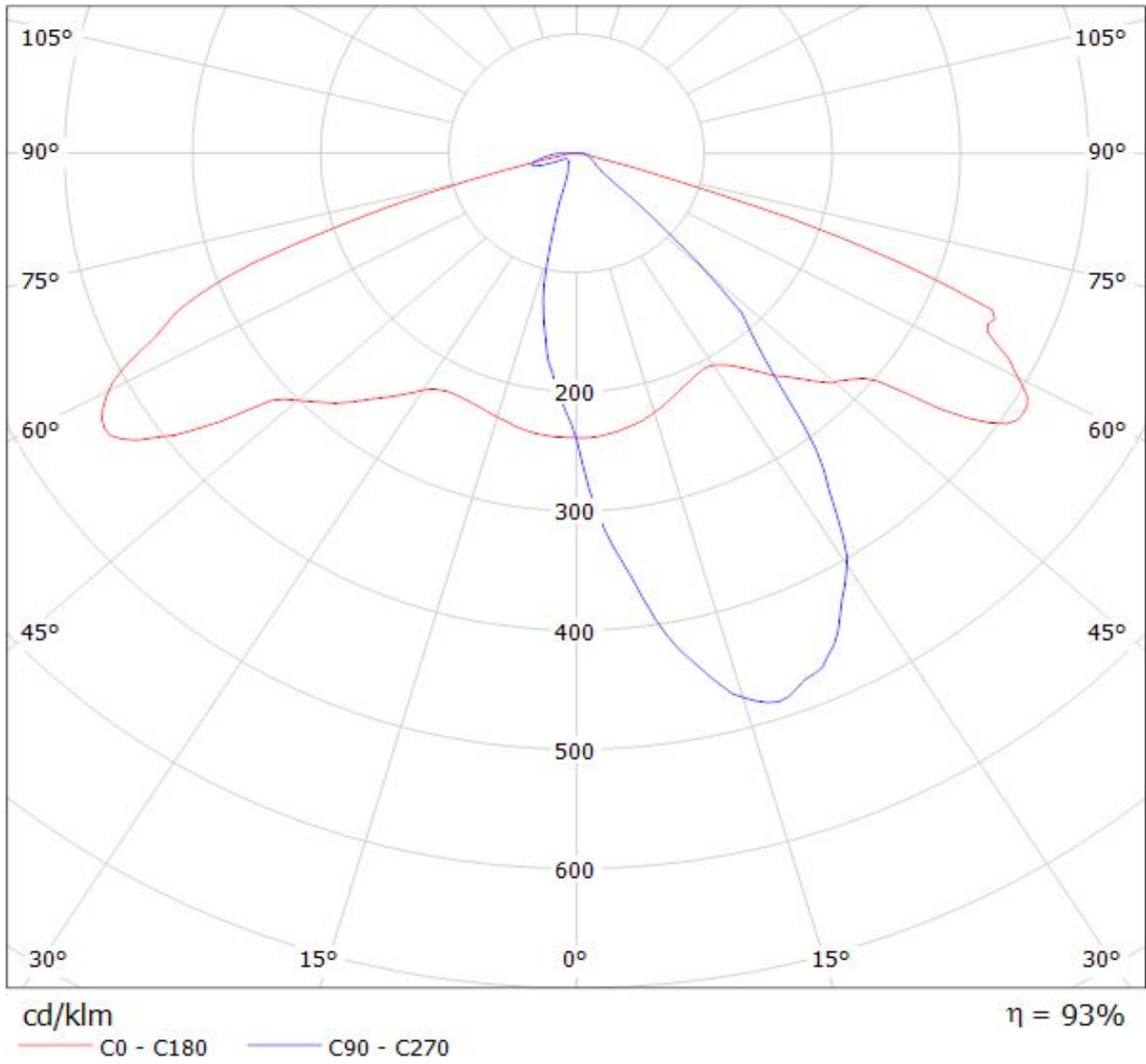

Luminaire: LEDiL Oy CA12411_STRADA-SQ-A-T_(OLP-5065F6L-06A)

Lamps: 1 x OPTOGAN_(OLP-5065F6L-06A-80-D05O0) 106.528lm@250mA CCT=5000K P=0.777664W I=249.9mA

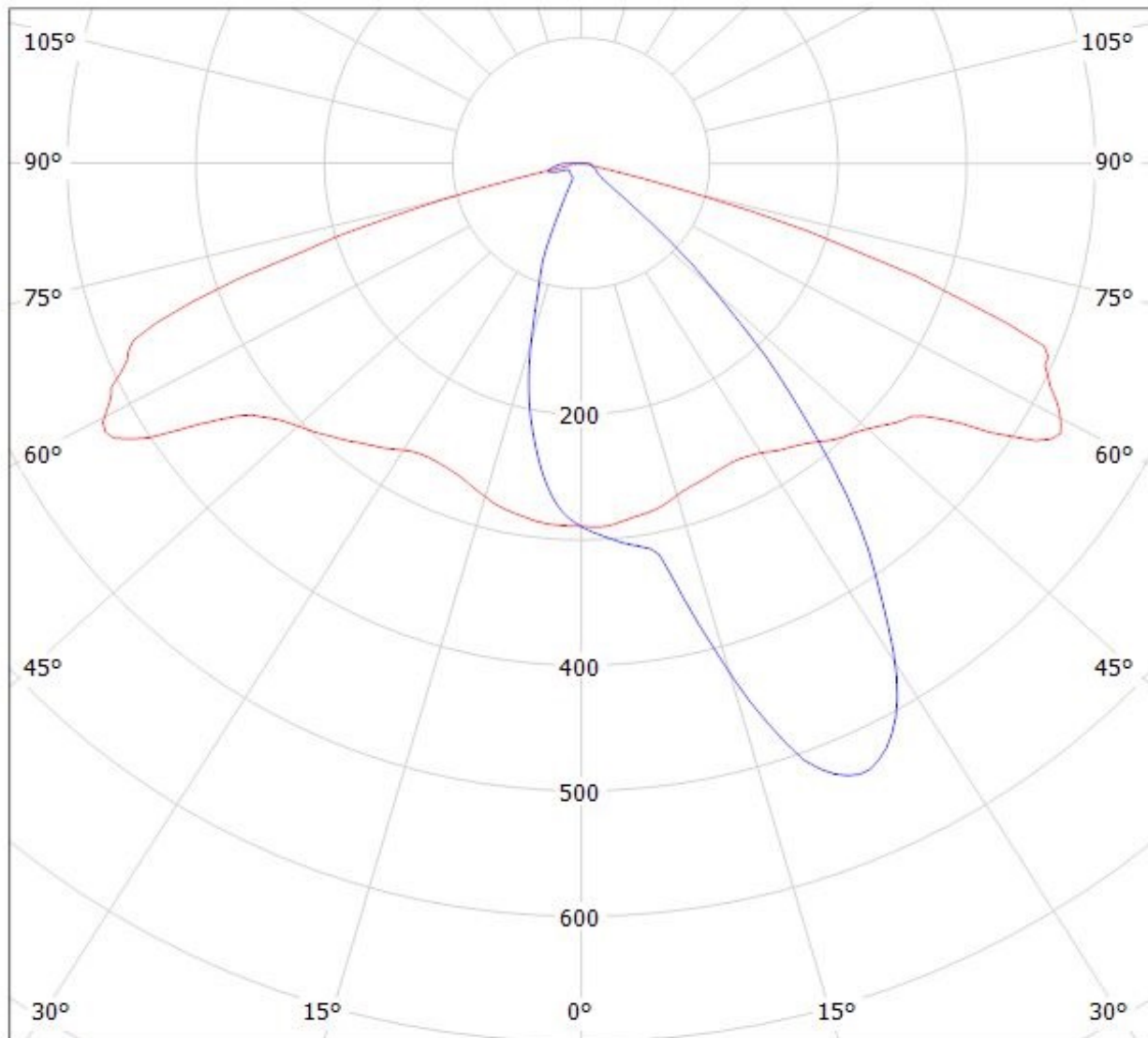

cd/klm

— C0 - C180

— C90 - C270

Luminaire: LEDiL Oy CA13119_STRADA-SQ-A-T_(OLP-5065F6L-06A) Eff.93%

Lamps: 1 x OPTOGAN_(OLP-5065F6L-06A-80-D0500) 106.528lm@250mA CCT=5000K P=0.777664W I=249.9mA

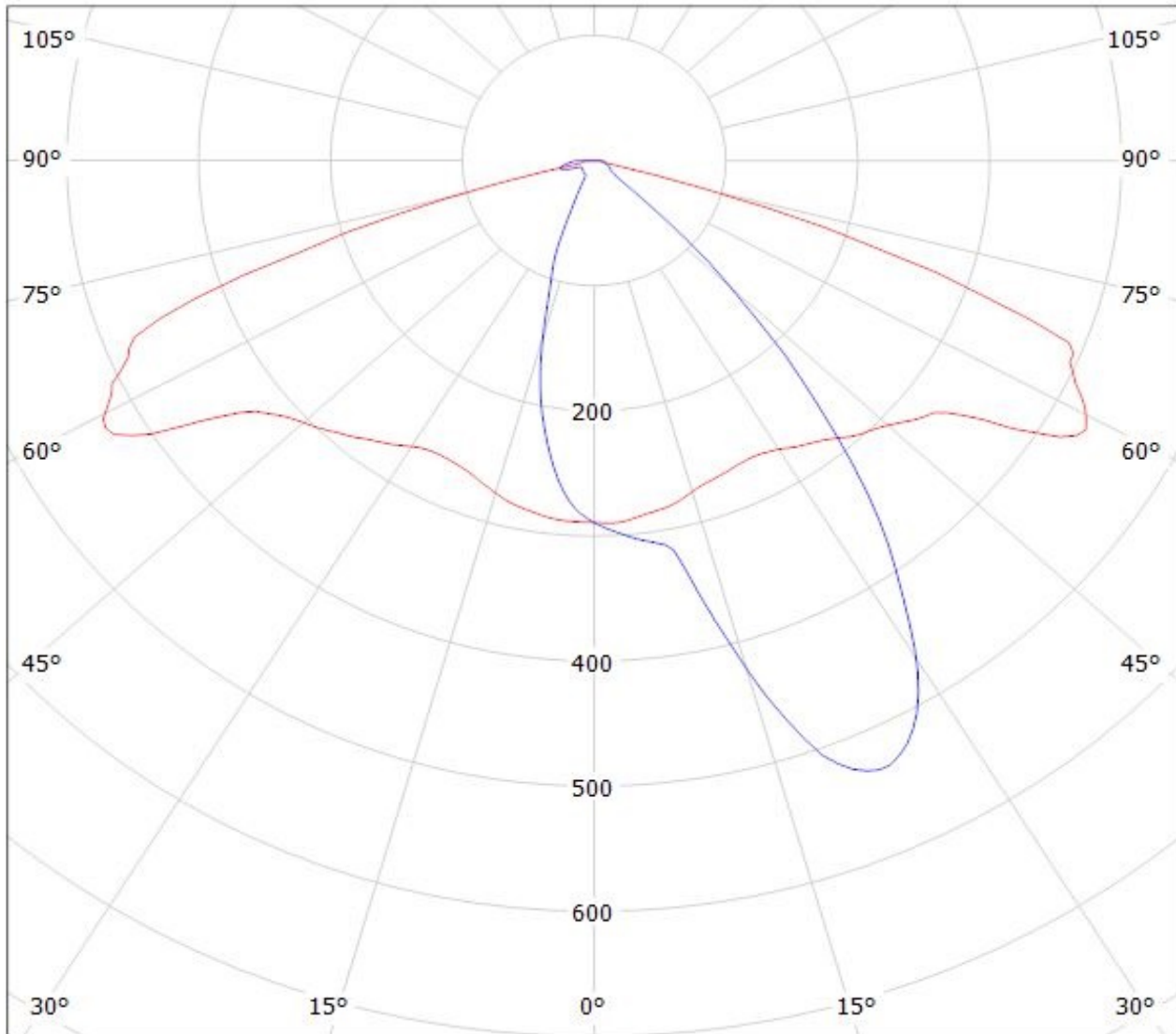

cd/klm

— C0 - C180

— C90 - C270

Luminaire: Ledil CA12411_STRADA-SQ-A-T_(Duris_S10)

Lamps: 1 x Osram_Duris_S10_(GW-P7LP32.EM)_992.375lm@250mA_P=9.2362W_I=0.25A

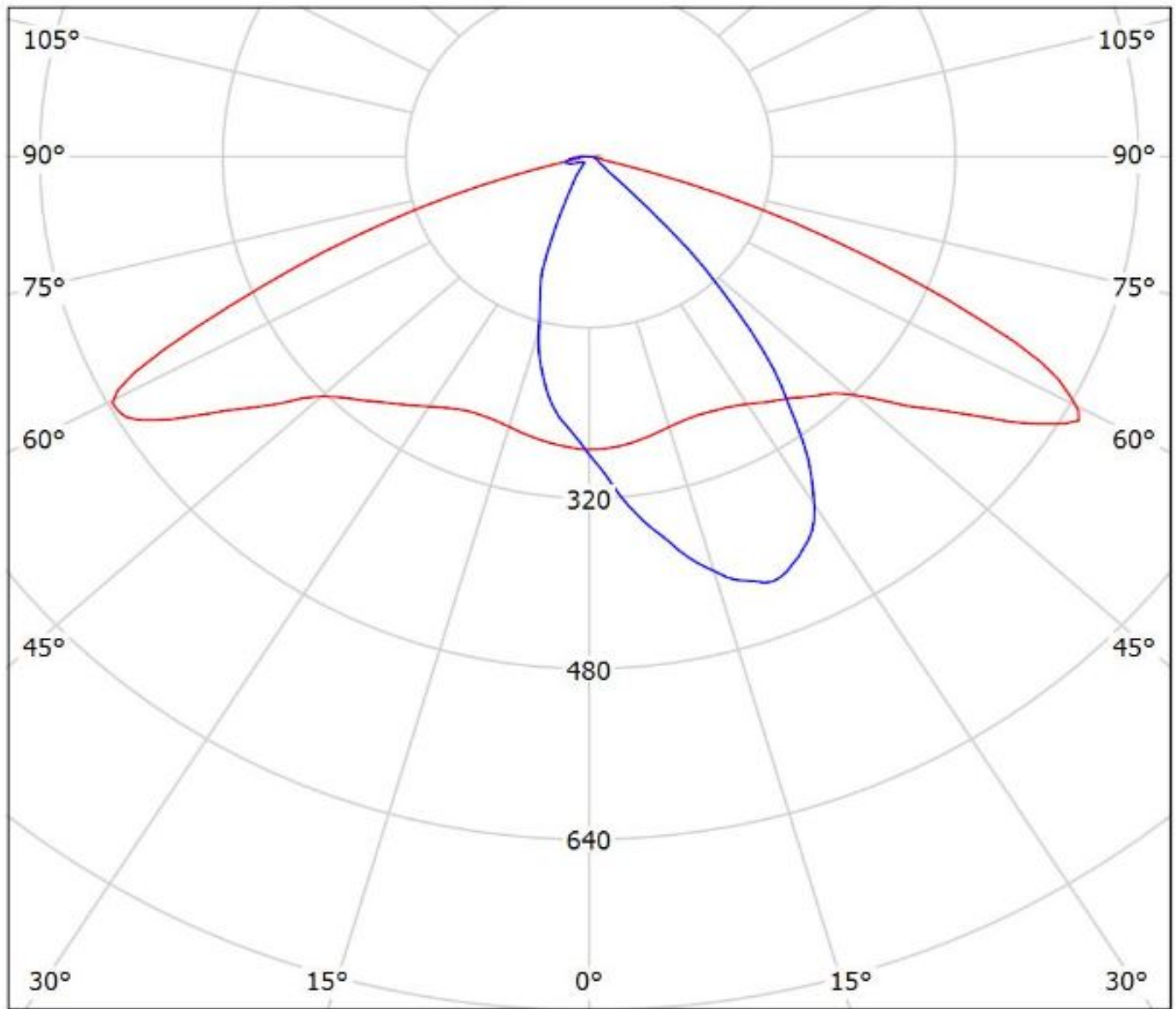

cd/klm
— C0 - C180 — C90 - C270

$\eta = 92\%$

NOTE: The typical divergence will be changed by different color, chip size and chip position tolerance. The typical total divergence is the full angle measured where the luminous intensity is half of the peak value.