

THIS IS A C.A.D. GENERATED DRAWING  
DO NOT MAKE MANUAL REVISIONS TO MASTER.

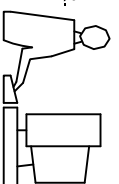

ISSUE NUMBER
REMOVE P/N: 690-009-221-900 R.STAMONICA MAY.07/10
ADD P/N: 690-009-521-900 AND 690-009-621-900 R.STAMONICA JUN.01/10
690-009-521-901 WAS 690-009-521-900 AND 690-009-621-901 WAS 690-009-621-900, ADD TAPE & REEL AND PCB TOLERANCE R.STAMONICA JUN.07/10

**ELECTRICAL SPECIFICATIONS:**

CURRENT RATING: 1 AMP .30VAC  
CONTACT RESISTANCE: 30 MILLIOHMS MAX.  
INSULATION RESISTANCE: 1000 MEGOHMS MIN.  
DWV: 500VAC  
TEMPERATURE RATING: -50°C TO +105°C

**MATERIALS:**

HOUSING AND COVER: PBT 30%G.F. UL94V-0 COLOR BLACK  
CONTACTS: COPPER ALLOY, PLATED WITH 15 MICRONS OF GOLD  
ON CONTACT AREA, TIN ON TAILS OVER NICKEL  
SHELL: BRASS, NICKEL PLATED  
COVER SHELL: COPPER ALLOY, NICKEL PLATED

**PC BOARD MOUNTING DIMENSIONS**

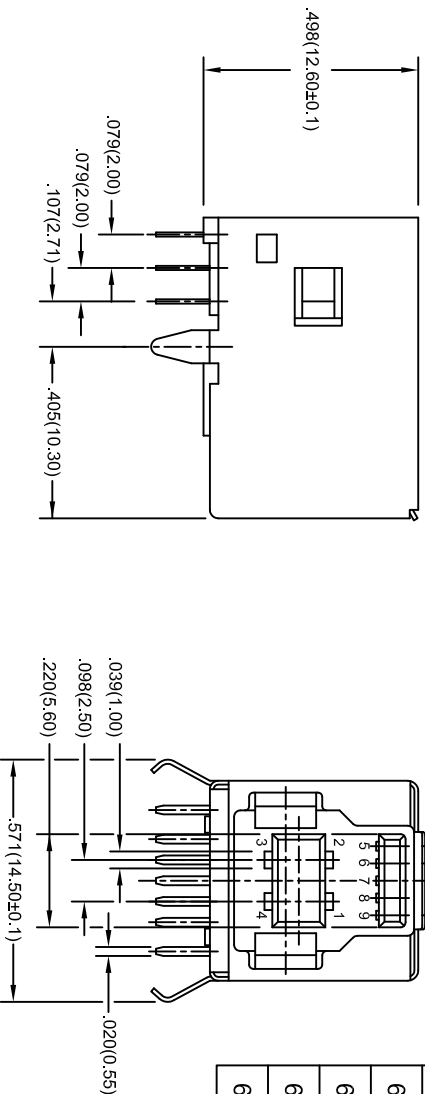
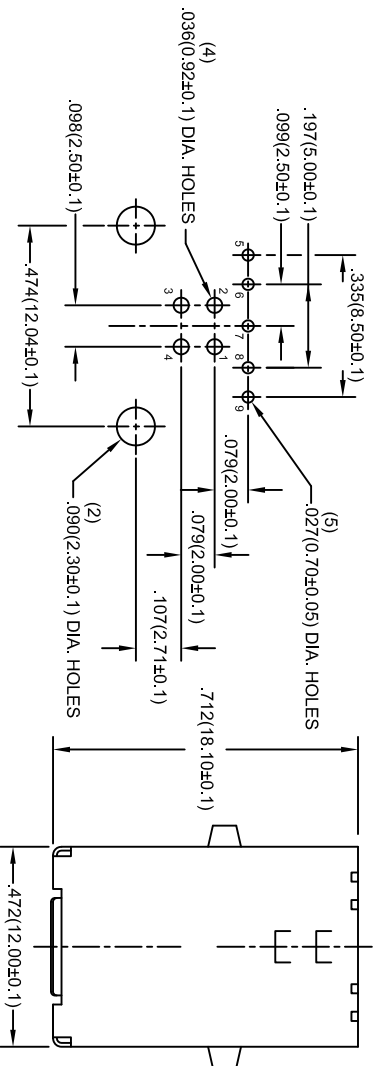

PART NUMBERS	GOLD PLATING	PACKAGING DETAIL
690-009-521-900	15 u" OF GOLD	TAPE AND REEL
690-009-521-901	15 u" OF GOLD	PLASTIC TRAY
690-009-621-900	30 u" OF GOLD	TAPE AND REEL
690-009-621-901	30 u" OF GOLD	PLASTIC TRAY

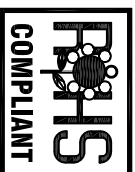

THIS SERIES FULLY CONFORMS TO THE  
EUROPEAN UNION DIRECTIVES 2002/95/EC  
AND 2002/96/EC FOR ROHS COMPLIANCY.

**USB-B RECEPTACLE 90° DIP, 3.0 VERSION**

ACAD REFERENCE NO.	690-009-521-900
DRAWN: F. BRIONES	DATE: AUG.17/09
PART NUMBER	SEE ABOVE

EDAC INC TORONTO, ONTARIO CANADA	YOUR CONNECTION TO QUALITY & SERVICE	THESE DRAWINGS AND SPECIFICATIONS ARE THE PROPERTY OF EDAC INC. AND SHALL NOT BE REPRODUCED, OR COPIED OR USED AS THE BASIS FOR THE MANUFACTURE OR SALE OF APPARATUS WITHOUT WRITTEN PERMISSION.	DRAWING NUMBER 690-009-521-900	SHEET 1 OF 3 ISSUE 8
--	--------------------------------------	---	-----------------------------------	----------------------------

THIS IS A C.A.D. GENERATED DRAWING  
DO NOT MAKE MANUAL REVISIONS TO MASTER.

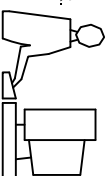

ISSUE NUMBER

SEE PAGE 1 OF 3

8

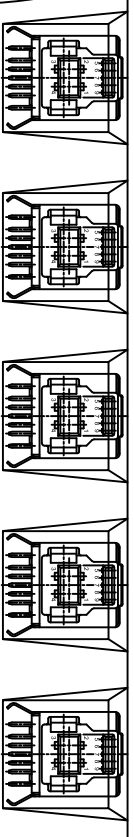
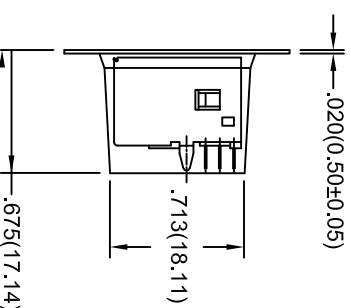
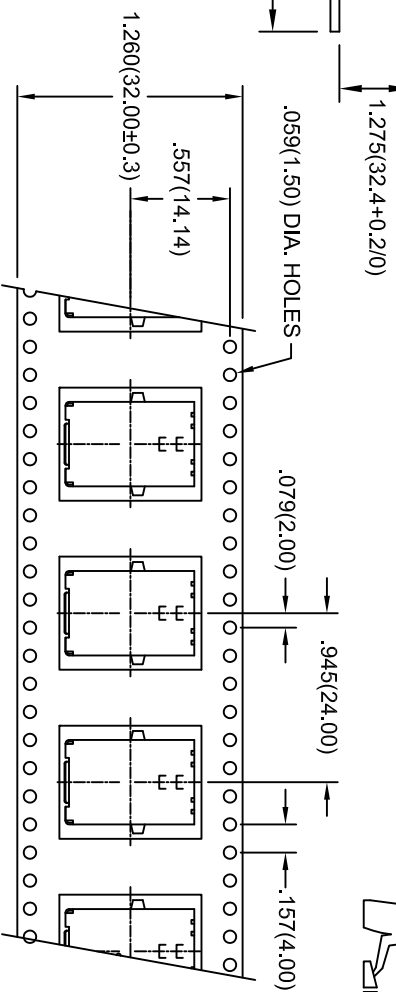
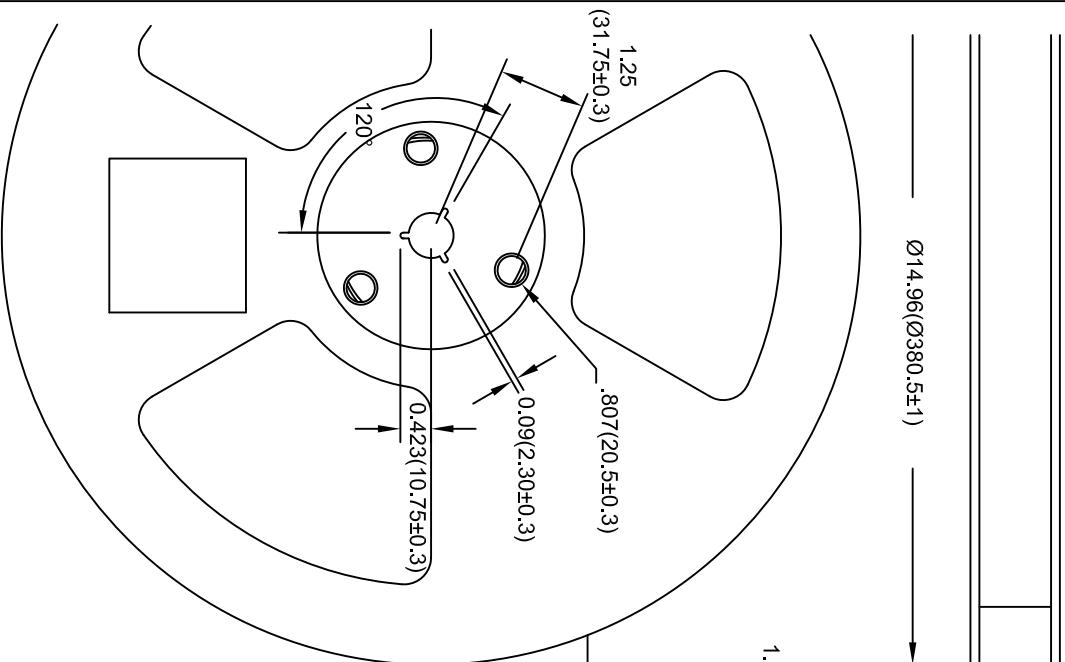

NOTE:  
TOLERANCE FOR ALL DIMENSIONS IN MM IS ±0.1, UNLESS OTHERWISE SPECIFIED

**USB-B RECEPTACLE 90° DIP, 3.0 VERSION  
PACKAGING REEL (200 PCS PER REEL)**

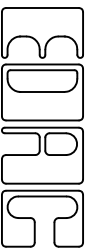

EDAC INC  
TORONTO, ONTARIO  
CANADA  
YOUR CONNECTION TO QUALITY & SERVICE

THESE DRAWINGS AND SPECIFICATIONS  
ARE THE PROPERTY OF EDAC INC. AND  
SHALL NOT BE REPRODUCED, OR COPIED  
OR USED AS THE BASIS FOR THE  
MANUFACTURE OR SALE OF APPARATUS  
WITHOUT WRITTEN PERMISSION.

ACAD REFERENCE NO. 690-009-521-013

DRAWN: F. BRIONES DATE: AUG. 17/09

PART NUMBER

SEE PAGE 1 OF 3

SHEET 2 OF 3

DRAWING NUMBER

690-009-521-900

ISSUE

8

THIS IS A C.A.D. GENERATED DRAWING  
DO NOT MAKE MANUAL REVISIONS TO MASTER.

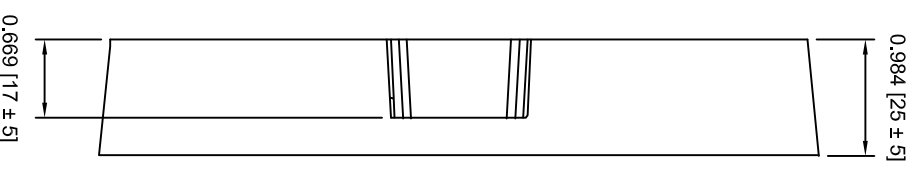
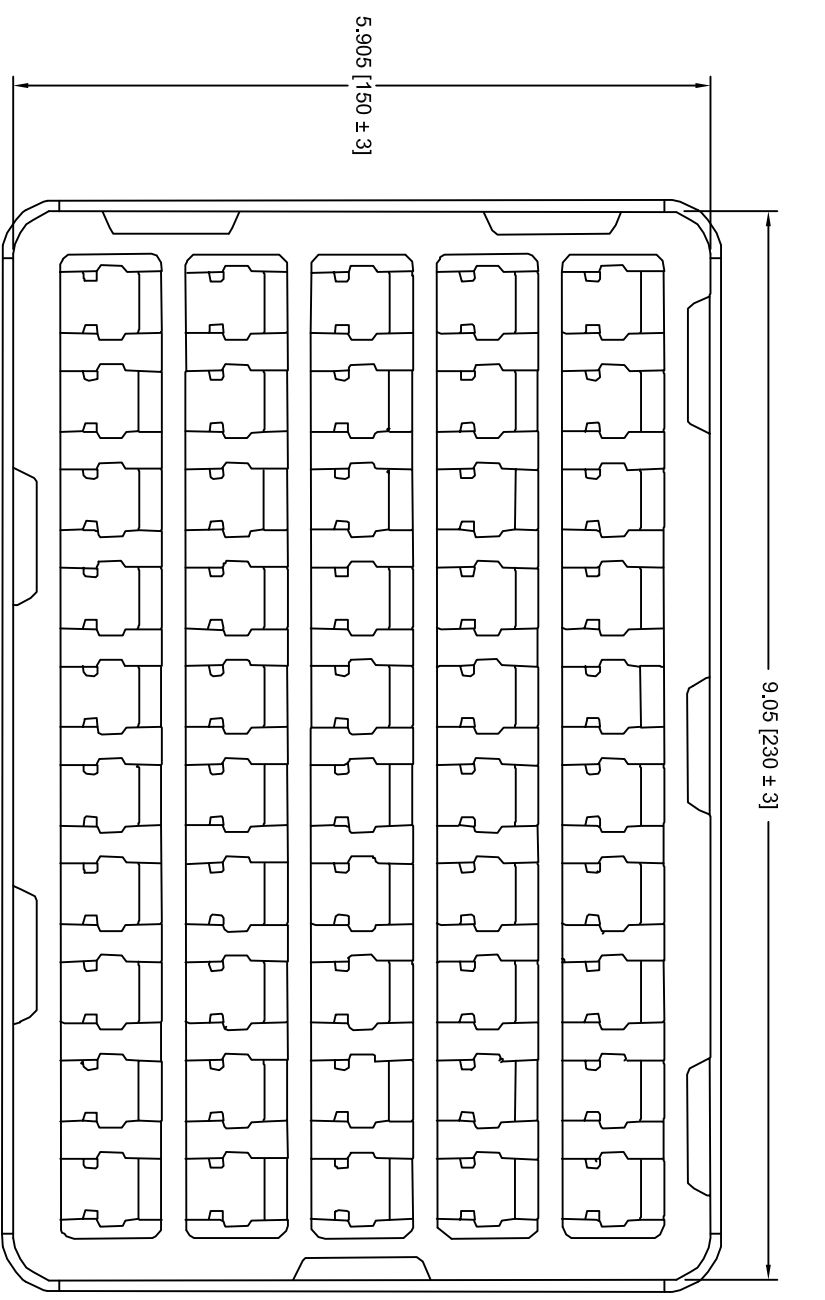
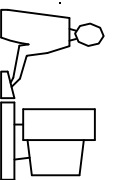

- NOTES:
1. MATERIAL: TRANSPARENT PVC
  2. THICKNESS: 0.20 ± 0.05MM
  3. PCS / TRAY : 50PCS
  4. TRAY / BOX : 30TRAYS
  5. PCS / BOX : 1500PCS
  6. CARTON SIZE:  
480MM x 250MM x 200MM

**USB-B RECEPTACLE 90° DIP, 3.0 VERSION  
TRAY PACKAGING (50 PCS PER TRAY)**

**EDAC INC**  
TORONTO, ONTARIO  
CANADA  
YOUR CONNECTION TO QUALITY & SERVICE

THESE DRAWINGS AND SPECIFICATIONS  
ARE THE PROPERTY OF EDAC INC., AND  
SHALL NOT BE REPRODUCED, OR COPIED  
OR USED AS THE BASIS FOR THE  
MANUFACTURE OR SALE OF APPARATUS  
WITHOUT WRITTEN PERMISSION.

ACAD REFERENCE NO.	690-009-521-013
DRAWN: R.STA. MONICA	DATE: JUN.01/10
PART NUMBER	SEE PAGE 1 OF 3
DRAWING NUMBER	690-009-521-900
	SHEET 3 OF 3
	ISSUE
	8