

BR1220

■ Dimensions(mm)

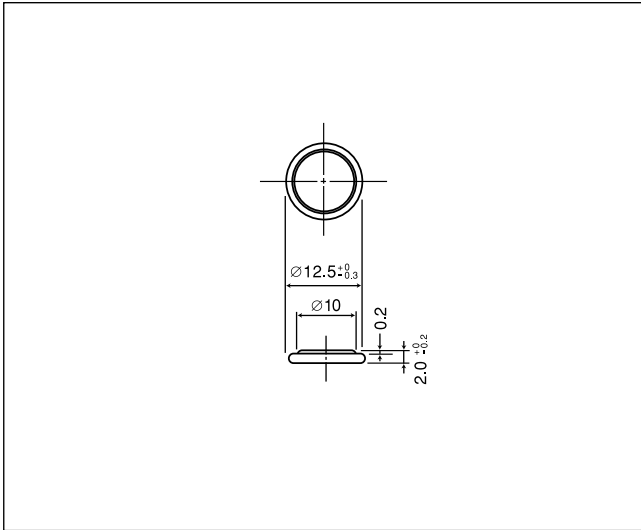

■ Specification

Nominal voltage(V)	3
Nominal capacity(mAh)	35
Continuous drain(mA)	0.03
Operating temperature(°C)	-30 to +80

■ Discharge temperature characteristics

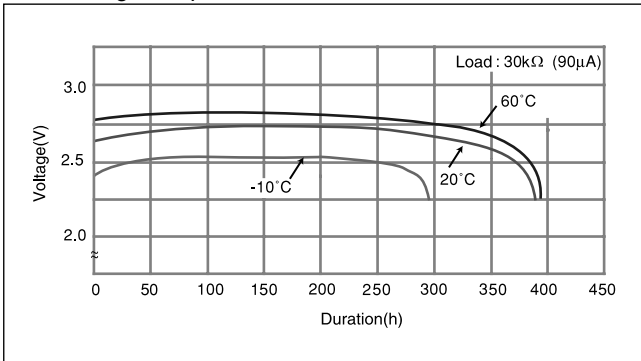

■ Operating voltage vs. load resistance(voltage at 50% discharge depth)

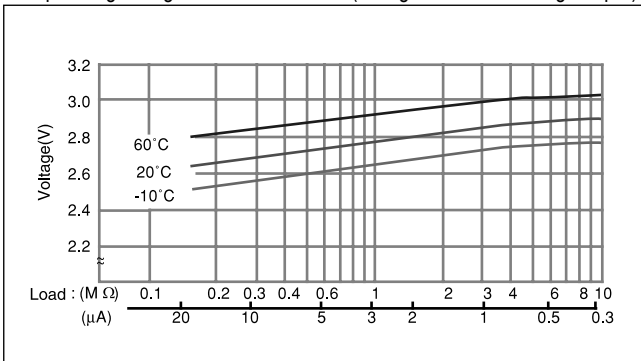

■ Capacity vs. load resistance

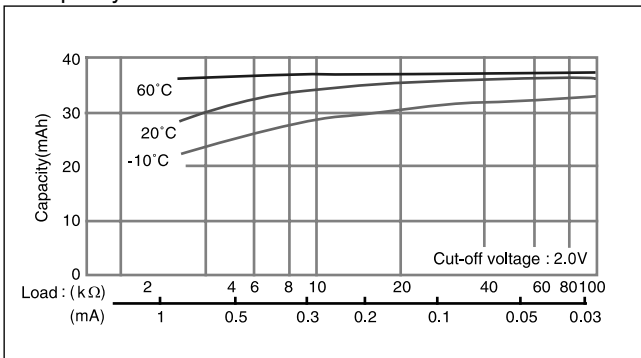

BR1225

■ Dimensions(mm)

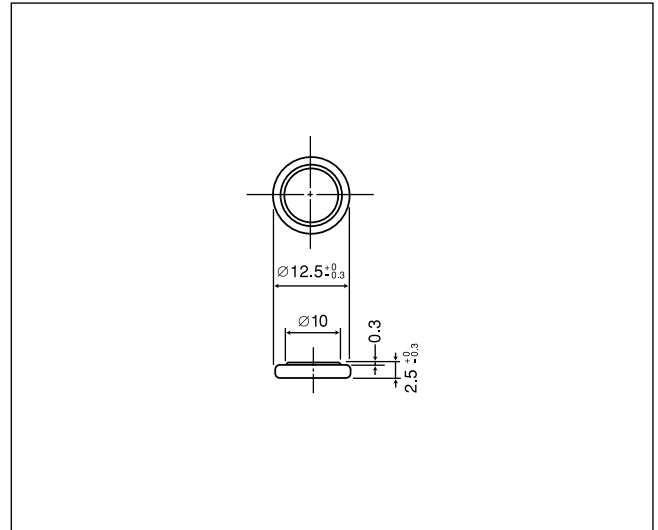

■ Specification

Nominal voltage(V)	3
Nominal capacity(mAh)	48
Continuous drain(mA)	0.03
Operating temperature(°C)	-30 to +80

■ Discharge temperature characteristics

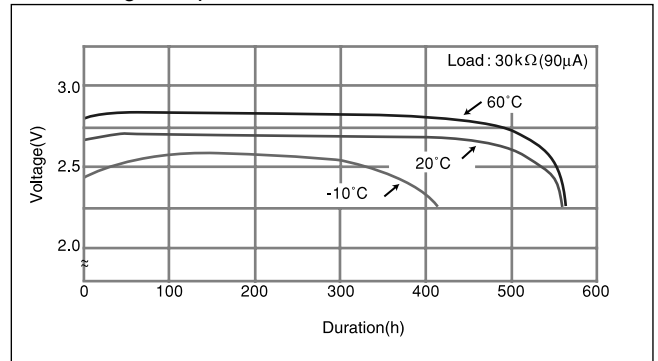

■ Operating voltage vs. load resistance(voltage at 50% discharge depth)

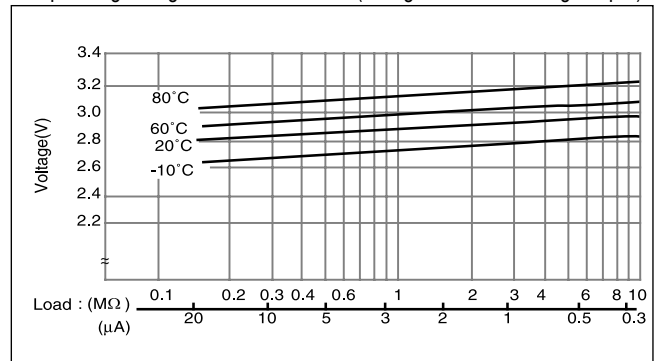

■ Capacity vs. load resistance

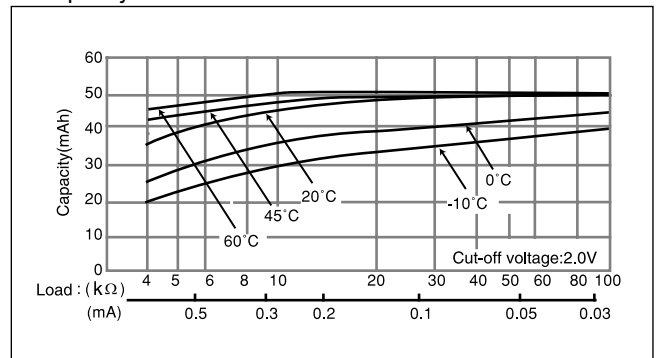

* The data in this document are for descriptive purposes only and are not intended to make or imply any guarantee or warranty.