

CPDQR12V0U

RoHS Device

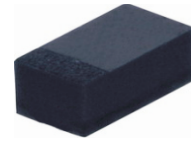

Features

- Uni-directional ESD protection.
- Surface mount package.
- Ultra small SMD package:0402.
- High component density.

Mechanical data

- Case: 0402/SOD-923F standard package, molded plastic.
- Terminals: Gold plated, solderable per MIL-STD-750,method 2026.
- Marking Code: Cathode band & E2
- Mounting position: Any.
- Weight: 0.001 gram(approx.).

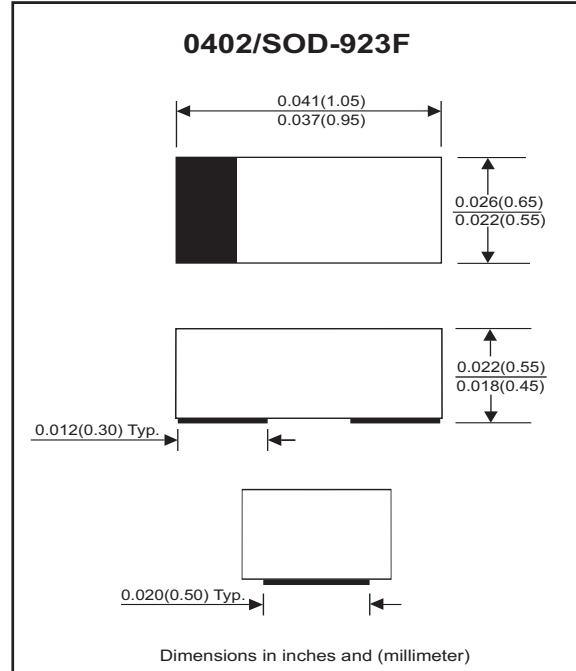

Maximum Rating AND Electrical Characteristics (at TA=25 °C unless otherwise noted)

Parameter	Conditions	Symbol	Min	Typ	Max	Unit
Forward voltage	I _F = 10mA	V _F		0.8		V
Diode breakdown voltage	I _R = 1mA	V _{BD}	13.3	15.5	17.5	V
Leakage current	V _R = 12V	I _L		0.1	1.0	uA
Junction capacitance	V _R = 0V, f = 1MHz	C _T			60	pF
ESD capability	IEC 61000-4-2(air) IEC 61000-4-2(contact)	ESD			30	kV
Clamping voltage	I _{PP} = 1A, T _P =8/20us I _{PP} = 5A, T _P =8/20us	V _C			19 24	V
Peak pulse power		P _{PP}			120	W
Operation temperature		T _J			125	°C
Storage temperature		T _{STG}	-55		150	°C

RATING AND CHARACTERISTIC CURVES (CPDQR12V0U)

Fig. 1 - 8/20us Peak pulse current wave form acc. IEC 61000-4-5

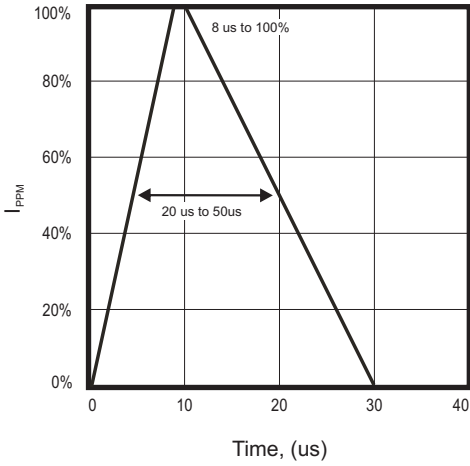

Fig. 2 - Power rating derating curve

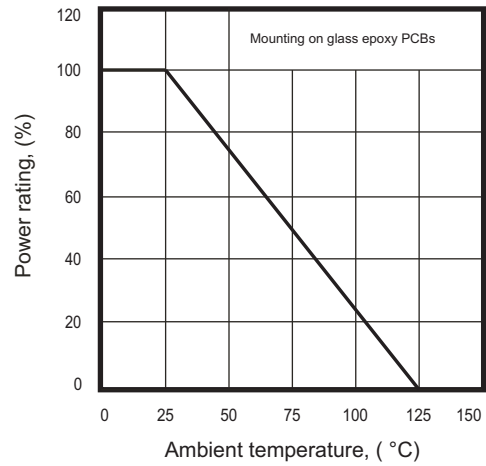

Fig. 3 - Clamping voltage vs. peak pulse current

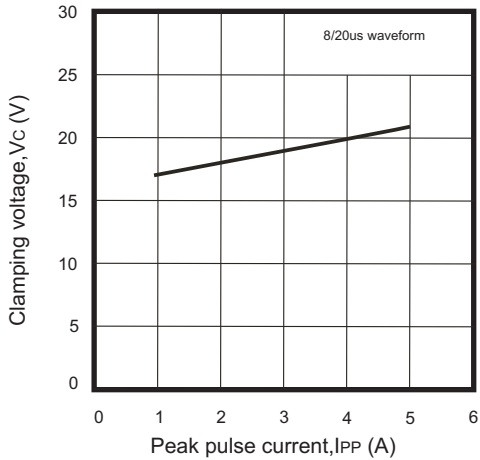

Fig. 4 - Forward voltage vs. forward current

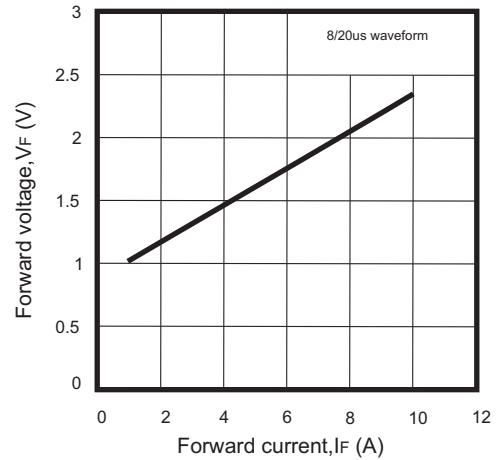
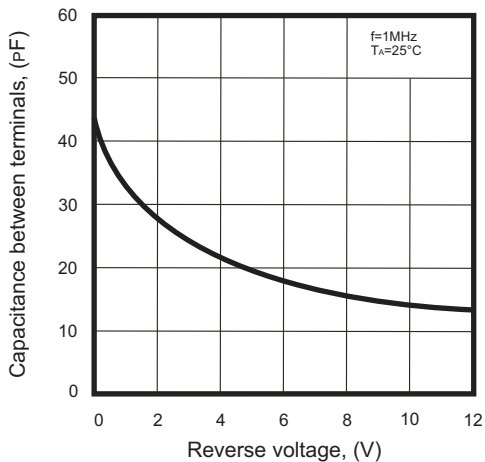
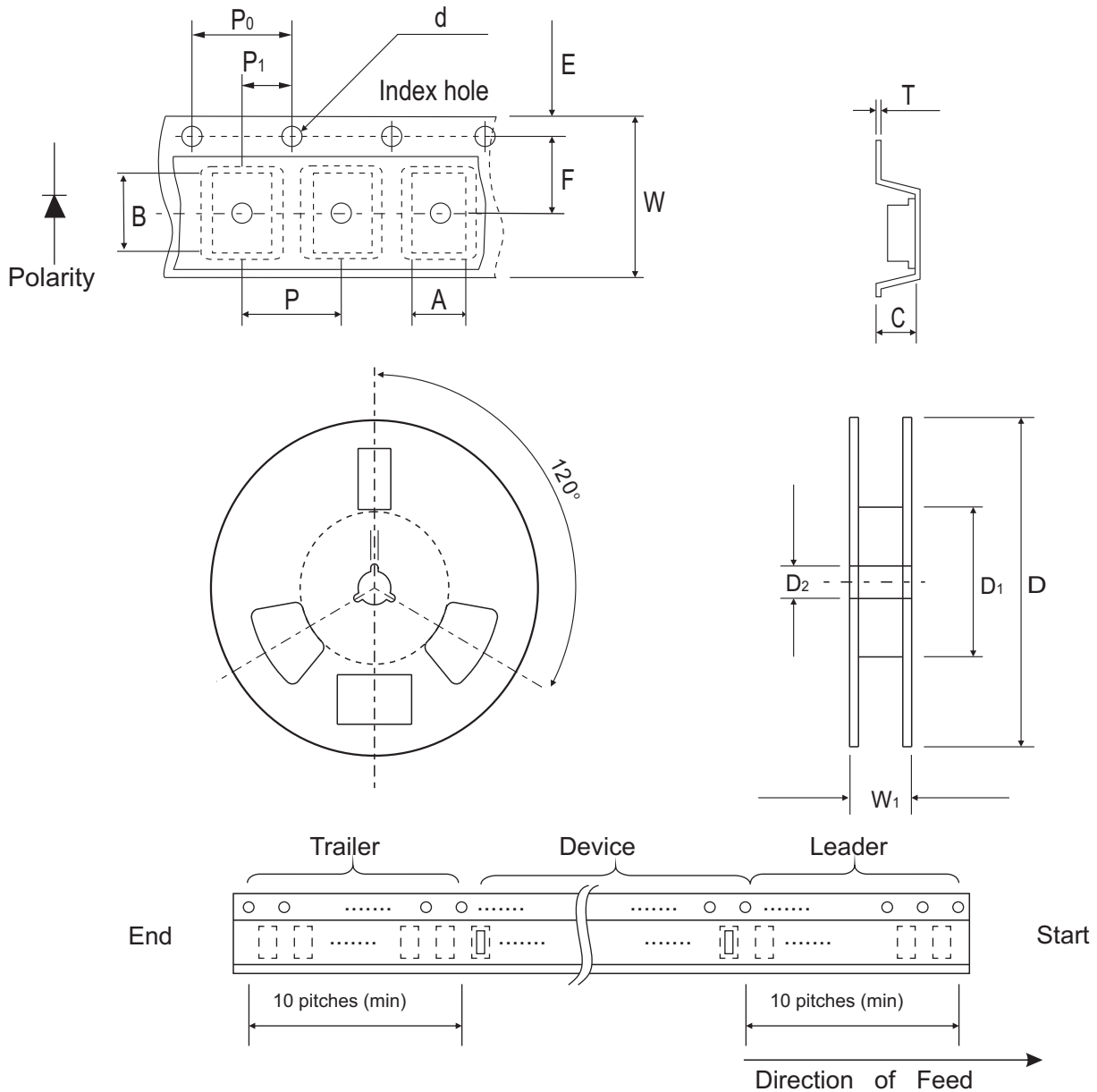

Fig. 5 - Capacitance between terminals characteristics



Reel Taping Specification



0402 (SOD-923F)	SYMBOL	A	B	C	d	D	D ₁	D ₂
	(mm)	0.75 ± 0.10	1.15 ± 0.10	0.60 ± 0.10	1.55 ± 0.10	178 ± 1	60.0 MIN.	13.0 ± 0.20
	(inch)	0.030 ± 0.004	0.045 ± 0.004	0.024 ± 0.004	0.061 ± 0.004	7.008 ± 0.04	2.362 MIN.	0.512 ± 0.008

0402 (SOD-923F)	SYMBOL	E	F	P	P ₀	P ₁	T	W	W ₁
	(mm)	1.75 ± 0.10	3.50 ± 0.05	4.00 ± 0.10	4.00 ± 0.10	2.00 ± 0.10	0.22 ± 0.05	8.00 ± 0.20	13.5 MAX.
	(inch)	0.069 ± 0.004	0.138 ± 0.002	0.157 ± 0.004	0.157 ± 0.004	0.079 ± 0.004	0.009 ± 0.002	0.315 ± 0.008	0.531 MAX.

Marking Code

Part Number	Marking Code
CPDQR12V0U	E2



Suggested PAD Layout

SIZE	0402/SOD-923F	
	(mm)	(inch)
A	0.750	0.030
B	0.500	0.020
C	0.700	0.028
D	1.250	0.049
E	0.250	0.010

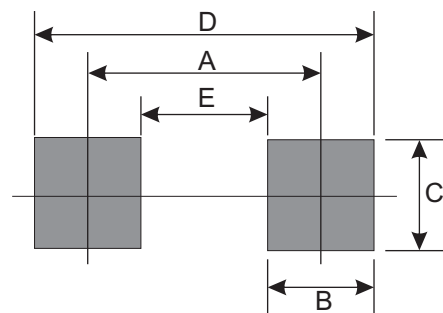

Standard Packaging

Case Type	Qty Per Reel	Reel Size
	(Pcs)	(inch)
0402/SOD-923F	5,000	7