



MIC7211/7221

IttyBitty® Rail-to-Rail Input Comparator

General Description

The MIC7211 and MIC7221 are micropower comparators featuring rail-to-rail input performance in Micrel's IttyBitty® SOT-23-5 package. The MIC7211/21 is ideal for systems where small size is a critical consideration.

The MIC7211/21 is optimized for single supply operation from 2.2V to 10V power supplies.

The MIC7211 features a conventional push-pull output while the MIC7221 has an open-drain output for mixed-voltage applications with an external pull-up resistor.

The MIC7211/21 benefits small battery-operated portable electronic devices where small size and the ability to place the comparator close to the signal source are primary design concerns.

Features

- Small footprint SOT-23-5 package
- Guaranteed performance at 2.2V, 2.7V, 5V, and 10V
- 7µA typical supply current at 5V
- <5µs response time at 5V
- Push-pull output (MIC7211)
- Open-drain output (MIC7221)
- Input voltage range may exceed supply voltage by 0.3V
- >100mA typical sink or source

Applications

- Battery-powered products
- Notebook computers and PDAs
- PCMCIA cards
- Cellular and other wireless communication devices
- Alarm and security circuits
- Direct sensor interface

Ordering Information

Part Number	Marking	Temp. Range	Package	Lead Finish
MIC7211BM5	A14	-40°C to +85°C	SOT-23-5	Standard
MIC7221BM5	A15	-40°C to +85°C	SOT-23-5	Standard
MIC7211YM5	A14	-40°C to +85°C	SOT-23-5	Pb-Free
MIC7221YM5	A15	-40°C to +85°C	SOT-23-5	Pb-Free

Pin Configuration

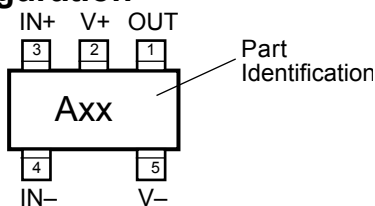

Functional Configuration

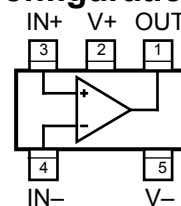

SOT-23-5 (M5)

Pin Description

Pin Number	Pin Name	Pin Function
1	OUT	Amplifier Output
2	V+	Positive Supply
3	IN+	Noninverting Input
4	IN-	Inverting Input
5	V-	Negative Supply

Absolute Maximum Ratings (Note 1)

Supply Voltage ($V_{V+} - V_{V-}$)	12V
Differential Input Voltage (V_{IN+}, V_{IN-})	$\pm(V_{V+} - V_{V-})$
I/O Pin Voltage (V_{IN+}, V_{OUT}), Note 3	$V_{V+} + 0.3V$ to $V_{V-} - 0.3V$
Junction Temperature (T_J)	+150°C
Storage Temperature (T_S)	-65°C to +150°C

ESD, **Note 6**

Operating Ratings (Note 2)

Supply Voltage ($V_{V+} - V_{V-}$)	2.2V to 10V
Junction Temperature (T_J)	-40°C to +85°C
Package Thermal Resistance (θ_{JA}) Note 5	235°C/W
Maximum Power Dissipation	Note 4

DC Electrical Characteristics (2.2V)

$V_{V+} = +2.2V$, $V_{V-} = 0V$, $V_{CM} = V_{OUT} = V_{V+}/2$; $T_J = 25^\circ C$, **bold** values indicate $-40^\circ C \leq T_J \leq +85^\circ C$; **Note 7**; unless noted

Symbol	Parameter	Condition	Min	Typ	Max	Units
V_{OS}	Input Offset Voltage			2	10	mV
TCV_{OS}	Input Offset Voltage Temperature Drift			1		$\mu V/^\circ C$
TCV_{OS}	Input Offset Voltage Drift Over Time			3.3		$\mu V/month$
I_B	Input Bias Current			0.5		pA
I_{OS}	Input Offset Current			0.25		pA
CMRR	Common-Mode Rejection Ratio	$0V \leq V_{CM} \leq 2.2V$		60		dB
PSRR	Positive Power Supply Rejection Ratio	$V_{V+} = 2.2V$ to 5V		90		dB
A_{VOL}	Gain			125		dB
V_{OH}	Output Voltage (High)	MIC7211, $I_{LOAD} = 2.5mA$	2.1	2.18		V
V_{OL}	Output Voltage (Low)	$I_{LOAD} = 2.5mA$		0.02	0.1	V
I_S	Supply Current	$V_{OUT} = low$		5	12	μA

DC Electrical Characteristics (2.7V)

$V_{V+} = +2.7V$, $V_{V-} = 0V$, $V_{CM} = V_{OUT} = V_{V+}/2$; $T_J = 25^\circ C$, **bold** values indicate $-40^\circ C \leq T_J \leq +85^\circ C$; **Note 7**; unless noted

Symbol	Parameter	Condition	Min	Typ	Max	Units
V_{OS}	Input Offset Voltage			2	10	mV
TCV_{OS}	Input Offset Voltage Temperature Drift			1		$\mu V/^\circ C$
TCV_{OS}	Input Offset Voltage Drift Over Time			3.3		$\mu V/month$
I_B	Input Bias Current			0.5		pA
I_{OS}	Input Offset Current			0.25		pA
CMRR	Common-Mode Rejection Ratio	$0V \leq V_{CM} \leq 2.7V$		65		dB
PSRR	Positive Power Supply Rejection Ratio	$V_{V+} = 2.7V$ to 5V		90		dB
A_{VOL}	Gain			125		dB
V_{OH}	Output Voltage (High)	MIC7211, $I_{LOAD} = 2.5mA$	2.6	2.68		V
V_{OL}	Output Voltage (Low)	$I_{LOAD} = 2.5mA$		0.02	0.1	V
I_S	Supply Current	$V_{OUT} = low$		5	12	μA

DC Electrical Characteristics (5V)
 $V_{V+} = +5.0V$, $V_{V-} = 0V$, $V_{CM} = V_{OUT} = V_{V+}/2$; $T_J = 25^{\circ}C$, **bold values indicate $-40^{\circ}C \leq T_J \leq +85^{\circ}C$; Note 7**; unless noted

Symbol	Parameter	Condition	Min	Typ	Max	Units
V_{OS}	Input Offset Voltage			2	10	mV
TCV_{OS}	Input Offset Voltage Temperature Drift			1		$\mu V/^{\circ}C$
TCV_{OS}	Input Offset Voltage Drift Over Time			3.3		$\mu V/month$
I_B	Input Bias Current			0.5		pA
I_{OS}	Input Offset Current			0.25		pA
CMRR	Common-Mode Rejection Ratio	$0V \leq V_{CM} \leq 5.0V$		70		dB
PSRR	Positive Power Supply Rejection Ratio	$V_{V+} = 5.0V$ to 10V		90		dB
A_{VOL}	Gain			125		dB
V_{OH}	Output Voltage (High)	MIC7211, $I_{LOAD} = 5mA$	4.9	4.95		V
V_{OL}	Output Voltage (Low)	$I_{LOAD} = 5mA$		0.05	0.1	V
I_S	Supply Current	$V_{OUT} = low$		7	14	μA
I_{SC}	Short Circuit Current	MIC7211, sourcing		150		mA
		sinking		110		mA

DC Electrical Characteristics (10V)
 $V_{V+} = +10V$, $V_{V-} = 0V$, $V_{CM} = V_{OUT} = V_{V+}/2$; $T_J = 25^{\circ}C$, **bold values indicate $-40^{\circ}C \leq T_J \leq +85^{\circ}C$; Note 7**; unless noted

Symbol	Parameter	Condition	Min	Typ	Max	Units
V_{OS}	Input Offset Voltage			2	10	mV
TCV_{OS}	Input Offset Voltage Temperature Drift			1		$\mu V/^{\circ}C$
TCV_{OS}	Input Offset Voltage Drift Over Time			3.3		$\mu V/month$
I_B	Input Bias Current			0.5		pA
I_{OS}	Input Offset Current			0.25		pA
CMRR	Common-Mode Rejection Ratio	$0V \leq V_{CM} \leq 10V$		75		dB
PSRR	Positive Power Supply Rejection Ratio	$V_{V+} = 5.0V$ to 10V		90		dB
A_{VOL}	Gain			125		dB
V_{OH}	Output Voltage (High)	MIC7211, $I_{LOAD} = 5mA$	9.9	9.95		V
V_{OL}	Output Voltage (Low)	$I_{LOAD} = 5mA$		0.05	0.1	V
I_S	Supply Current	$V_{OUT} = low$		12	25	μA
I_{SC}	Short Circuit Current	MIC7211, sourcing		165		mA
		sinking		125		mA

AC Electrical Characteristics

$V_{V-} = 0V$, $V_{CM} = V_{OUT} = V_{V+}/2$; $T_J = 25^{\circ}C$, **bold** values indicate $-40^{\circ}C \leq T_J \leq +85^{\circ}C$; **Note 7**; unless noted

Symbol	Parameter	Condition	Min	Typ	Max	Units
t_{RISE}	Rise Time	$V_{V+} = 5.0V$, $f = 10kHz$, $C_{LOAD} = 50pF$ overdrive = 10mV, Note 9		75		ns
t_{FALL}	Fall Time	$V_{V+} = 5.0V$, $f = 10kHz$, $C_{LOAD} = 50pF$ overdrive = 10mV, Note 9		70		ns
t_{PHL}	Propagation Delay-High to Low	$V_{V+} = 2.2V$, $f = 10kHz$, $C_{LOAD} = 50pF$ overdrive = 10mV, Note 9		10		μs
		$V_{V+} = 2.2V$, $f = 10kHz$, $C_{LOAD} = 50pF$ overdrive = 100mV, Note 9		6.0		μs
		$V_{V+} = 5.0V$, $f = 10kHz$, $C_{LOAD} = 50pF$ overdrive = 10mV, Note 9		13		μs
		$V_{V+} = 5.0V$, $f = 10kHz$, $C_{LOAD} = 50pF$ overdrive = 100mV, Note 9		5		μs
t_{PLH}	Propagation Delay-Low to High	$V_{V+} = 2.2V$, $f = 10kHz$, $C_{LOAD} = 50pF$ overdrive = 10mV, Note 9		13.5		μs
		$V_{V+} = 2.2V$, $f = 10kHz$, $C_{LOAD} = 50pF$ overdrive = 100mV, Note 9		4.0		μs
		$V_{V+} = 5.0V$, $f = 10kHz$, $C_{LOAD} = 50pF$ overdrive = 10mV, Note 9		11.5		μs
		$V_{V+} = 5.0V$, $f = 10kHz$, $C_{LOAD} = 50pF$ overdrive = 100mV, Note 9		3.0		μs

- Note 1.** Exceeding the absolute maximum rating may damage the device.
- Note 2.** The device is not guaranteed to function outside its operating rating.
- Note 3.** I/O pin voltage is any external voltage to which an input or output is referenced.
- Note 4.** The maximum allowable power dissipation is a function of the maximum junction temperature, $T_{J(max)}$; the junction-to-ambient thermal resistance, θ_{JA} ; and the ambient temperature, T_A . The maximum allowable power dissipation at any ambient temperature is calculated using $P_{D(max)} = (T_{J(max)} - T_A) \div \theta_{JA}$. Exceeding the maximum allowable power dissipation will result in excessive die temperature.
- Note 5.** Thermal resistance, θ_{JA} , applies to a part soldered on a printed circuit board.
- Note 6.** Devices are ESD sensitive. Handling precautions recommended.
- Note 7.** All limits guaranteed by testing on statistical analysis.
- Note 8.** Continuous short circuit may exceed absolute maximum T_J under some conditions.
- Note 9.** The MIC7221 requires 5k Ω pull-up resistor.

Partial Functional Diagrams

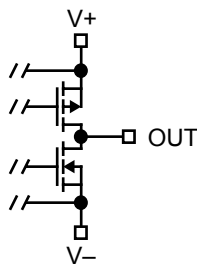

MIC7211 Push-Pull Output

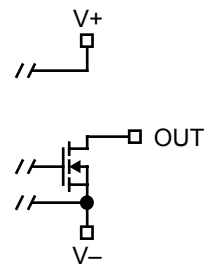

MIC7221 Open-Drain Output

Application Information

The small outline and low supply current (typically 7µA at 5V) of the MIC7211/21 are the primary advantages of these comparators. They have been characterized for 2.2V, 2.7V, 5V, and 10V operation.

Their 2.2V capability is especially useful in low-battery voltage situations. Low-voltage operation allows longer battery life or deeper discharge capability. Even at 2.2V, the output can drive several logic-gate inputs. At 2.5mA, the output stage voltage drop is guaranteed to not exceed 0.1V.

Outputs

The MIC7211 has a push-pull output while the MIC7221 has an open-drain output, otherwise both comparators share a common design.

The open-drain MIC7221 output can be pulled up to 10V, even when the supply voltage is as low as 2.2V. Conversely, the output also can be pulled up to voltages that are lower than the positive supply. Logic-level translation is readily facilitated by the ability to pull the open-drain output to voltages above or below the power supply.

Although specified short-circuit output current specified for these parts typically exceeds 100mA, their output is not intended to sink or source anywhere near 100mA. The short-circuit rating is only presented as additional information regarding output impedance and may be useful for determining the voltage drop one may experience when driving a given load.

Input Bias Current

The low input-bias current (typically 0.5pA) requirement of the MIC7211/21 provides flexibility in the kinds of circuitry and devices that can be directly interfaced.

Designs using an amplifier for transducer-to-comparator impedance transformation may be simplified by using the MIC7211/21's low-input-current requirement to eliminate the amplifier.

Input Signal Levels

Input signals may exceed either supply rail by up to 0.2V without phase inversion or other adverse effects. The inputs have internal clamp diodes to the supply pins.

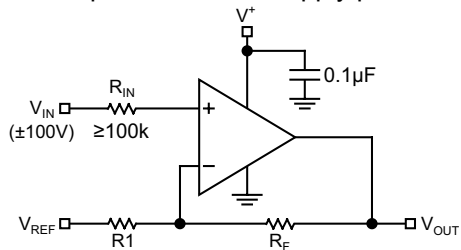

Figure 1. Driving the Input Beyond the Supply Rails

Larger input swings can be accommodated if the input current is limited to 1mA or less. Using a 100k input resistor will allow an input to swing up to 100V beyond either supply rail. Because of the low input bias current of the device, even larger input resistors are practical. See Figure 1. The ability to swing the input beyond either rail facilitates some otherwise difficult

circuits, such as a single-supply zero-crossing detector or a circuit that senses its own supply voltage.

The comparator must be powered if an input is pulled above the rail, even with current limiting in effect. Figure 2 shows a hypothetical situation where an input is pulled higher than the rail when the power supply is off or not present. Figure 2 also shows external clamp diodes for additional input circuit protection. Discrete clamp diodes can be arbitrarily more robust than the internal clamp diodes.

The power supply has been simplified (real power supplies do not have a series output diode); however, this illustrates a common characteristic of most positive-voltage power supplies: they are designed to source, but not sink, current. If the supply is off, or disconnected, there is no limiting voltage for the clamp diode to reference. The input signal can charge the bypass capacitor, and possibly the filter capacitor, up to the applied input (V_{IN}). This may be high enough to cause a thin-oxide rupture in a CMOS integrated circuit.

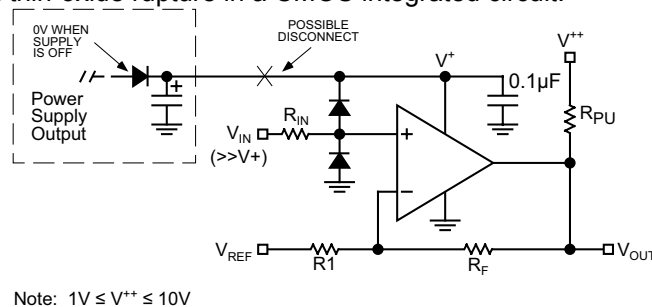

Figure 2. Avoid This Condition

Ideally, the supply for the comparator and the input-producing circuitry should be the same or be switched simultaneously.

Bypass Capacitors

CMOS circuits, especially logic gates with their totem-pole (push-pull) output stages, generate power supply current spikes (noise) on the supply and/or ground lines. These spikes occur because, for a finite time during switching, both output transistors are partially on allowing “shoot-through current.” Bypass capacitors reduce this noise.

Adequate bypassing for the MIC7211 comparator is 0.01µF; in low-noise systems, where this noise may interfere with the functioning or accuracy of nearby circuitry, 0.1µF is recommended. Because the MIC7221 does not have a totem-pole output stage, this spiking is not evident; however, switching a capacitive load can present a similar situation.

Thermal Behavior

The thermal impedance of a SOT-23-5 package is 325°C/W. The 5V Electrical Characteristics table shows a maximum voltage drop of 0.1V for a 5mA output current, making the output resistance about 20Ω ($R = 0.1/0.005 = 20\Omega$). Attempting to draw the typical specified output short-circuit current of 150mA (sourcing) can be expected to cause a die temperature rise of 146°C. (Operating die temperature for ICs should generally not exceed 125°C.) Using a series resistance is the simplest form of protecting against damage by excessive output current.

Package Information

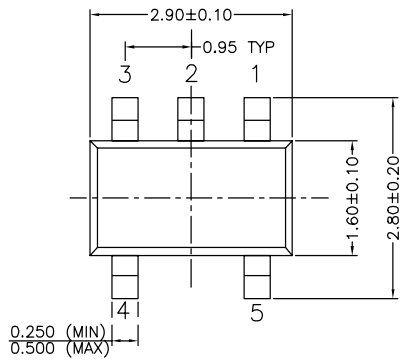

TOP VIEW

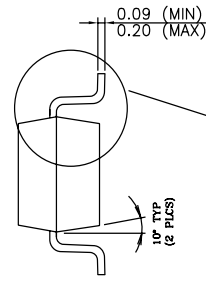

END VIEW

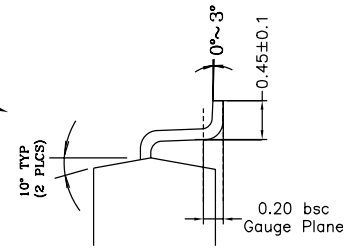

DETAIL

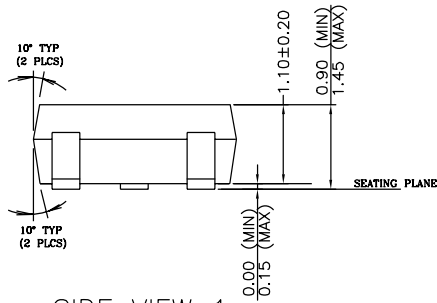

SIDE VIEW 1

NOTE:

1. PACKAGE OUTLINE EXCLUSIVE OF MOLD FLASH & BURR.
2. PACKAGE OUTLINE INCLUSIVE OF SOLER PLATING.
3. DIMENSION AND TOLERANCE PER ANSI Y14.5M, 1982.
4. FOOT LENGTH MEASUREMENT BASED ON GAUGE PLANE METHOD.
5. DIE FACES UP FOR MOLD, AND FACES DOWN FOR TRIM/FORM.
6. ALL DIMENSIONS ARE IN MILLIMETERS.

SOT-23-5 (M5)

MICREL INC. 2180 FORTUNE DRIVE SAN JOSE, CA 95131 USA
TEL + 1 (408) 944-0800 FAX + 1 (408) 474-1000 WEB <http://www.micrel.com>

The information furnished by Micrel in this data sheet is believed to be accurate and reliable. However, no responsibility is assumed by Micrel for its use. Micrel reserves the right to change circuitry and specifications at any time without notification to the customer.

Micrel Products are not designed or authorized for use as components in life support appliances, devices or systems where malfunction of a product can reasonably be expected to result in personal injury. Life support devices or systems are devices or systems that (a) are intended for surgical implant into the body or (b) support or sustain life, and whose failure to perform can be reasonably expected to result in a significant injury to the user. A Purchaser's use or sale of Micrel Products for use in life support appliances, devices or systems is a Purchaser's own risk and Purchaser agrees to fully indemnify Micrel for any damages resulting from such use or sale.

© 2005 Micrel Incorporated.