

THIS DOCUMENT IS THE PROPERTY OF
KEYSTONE ELECTRONICS CORP. AND
SHALL NOT BE REPRODUCED, DISTRIBUTED
OR USED AS A BASIS FOR MANUFACTURE
WITHOUT PRIOR WRITTEN PERMISSION
FROM KEYSTONE ELECTRONICS CORP.

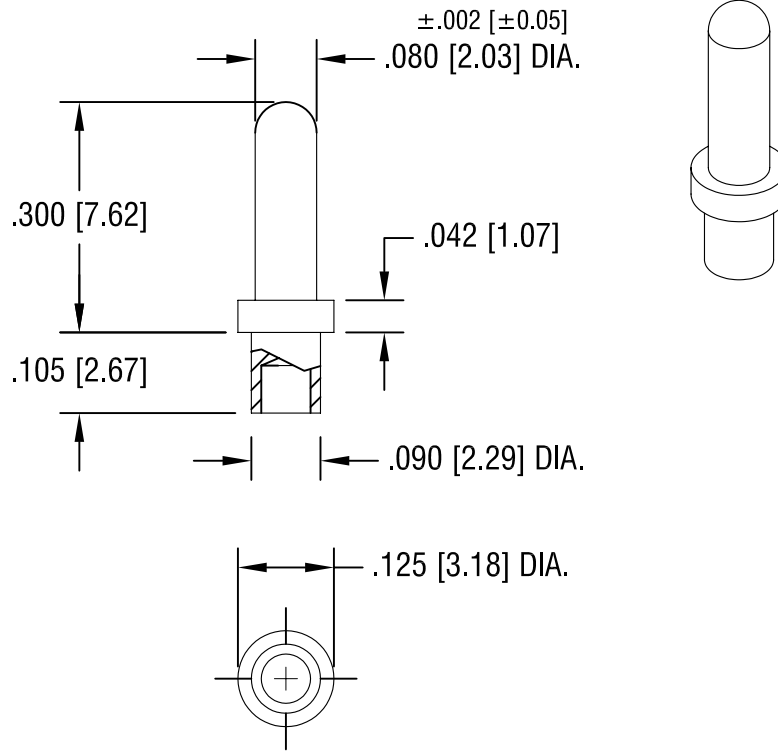

KEYSTONE ELECTRONICS CORP.			
ASTORIA, N.Y. 11105-2017			
PART NAME			
MICRO PIN, SWAGE MOUNT			
MATERIAL			
BRASS			
FINISH		DRN BY	DATE
GOLD PLATE		BOONE	2.22.07
		APP'D	SCALE
		LN	4X
TOLERANCES	INCH [MM]	CODE	DWG NO.
DECIMAL	± .005 [± 0.15]	C	1376-2
ANGULAR	± 1°		
UNLESS OTHERWISE SPECIFIED			

4.16.08	CHANGE AS PER ECN 08-101	A
DATE	DESCRIPTION	REV.