

THIS DRAWING IS UNPUBLISHED.

RELEASED FOR PUBLICATION

OCT , 1995.

© COPYRIGHT 1995 By -

ALL RIGHTS RESERVED.

REVISIONS

変更

P	LTR	DESCRIPTION	DATE	DWN	APVD
A		REVISED ECR-08-000340	01FEB08	T.T	T.F
A1		OBSOLETE PER ECO-16-011823	10AUG2016	B.J	S.Y

AS SHOWN: TYPE-1

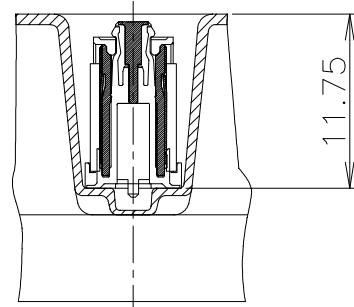
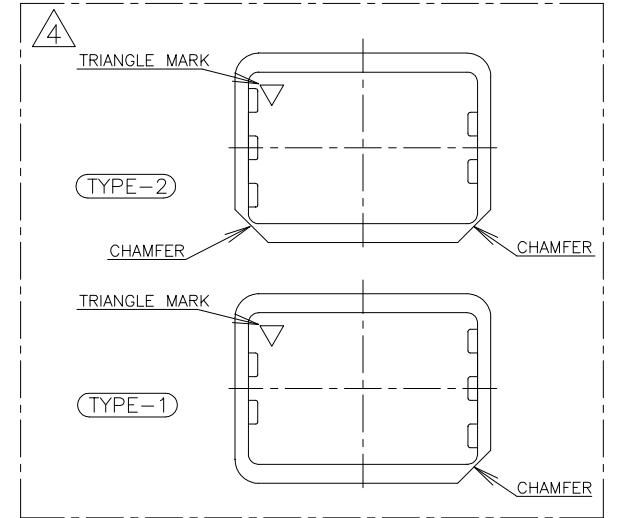

E-E (SCALE 2:1)

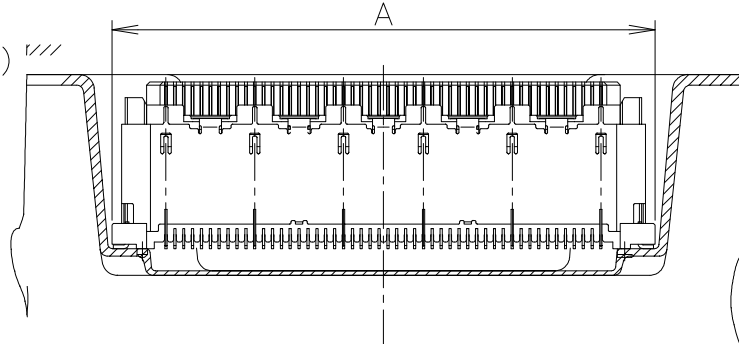

D-D (SCALE 2:1)

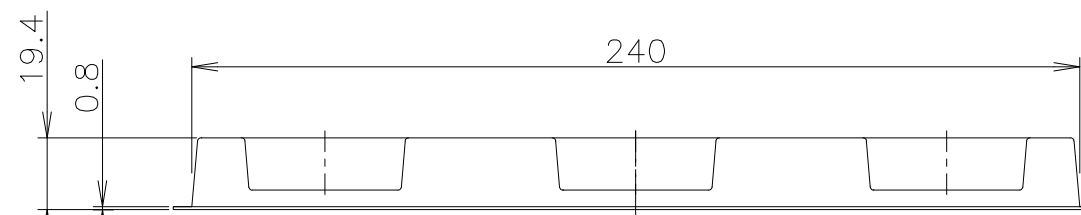
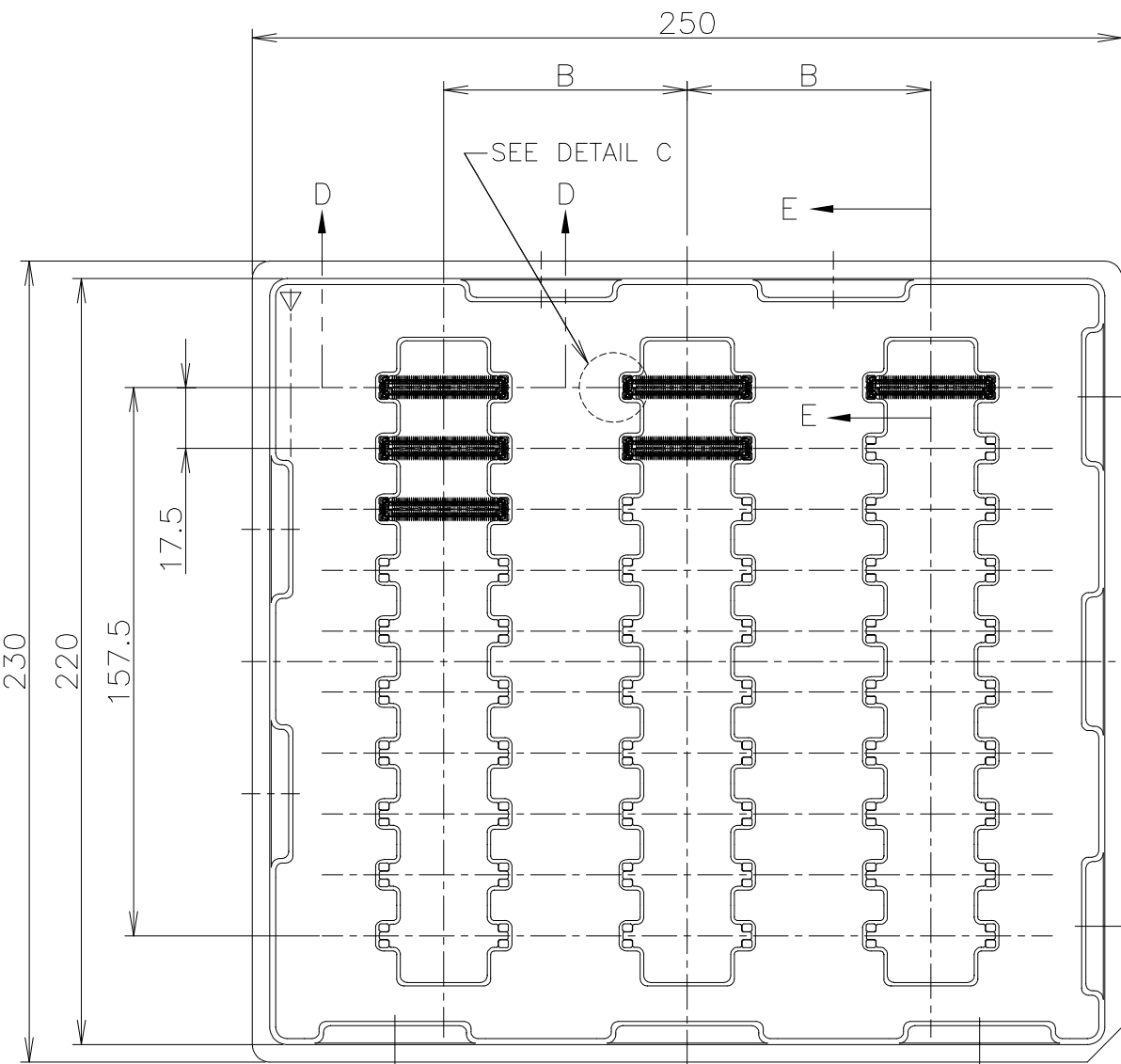

A1) OBSOLETE	SEALANT	TOOLING STATUS	ROW	QTY	B	A	POS.	TRAY P/N	PART NO.
AVAILABLE	3	30	70	54.7	160	7-912063-9	6-5316564-1		
AVAILABLE	↑	↑	↑	48.7	140	7-912063-6	6-↑	↑	-0
NOT AVAILABLE	↓	↓	↓	42.7	120	7-912067-1	5-	↓	-9
↑	↓	↓	↓	36.7	100	7-↑	↑	-0	5-
↑	3	30	70	33.7	90	6-	↑	-9	5-
↑	5	50	43	30.7	80	6-	↑	-8	5-
↑	↑	↑	↑	27.7	70	6-	↑	-7	5-
↑	↑	↑	↑	24.7	60	6-	↑	-6	5-
↑	↑	↑	↑	21.7	50	6-	↑	-5	5-
↑	↑	↑	↑	18.7	40	6-	↑	-4	5-
↑	↑	↑	↑	15.7	30	6-	↑	-3	5-
NOT AVAILABLE	5	50	43	15.7	30	6-912067-3	5-5316564-1		
AVAILABLE	3	30	70	54.7	160	7-912063-9	1-5316564-1		
AVAILABLE	↑	↑	↑	48.7	140	7-912063-6	1-↑	↑	-0
NOT AVAILABLE	↓	↓	↓	42.7	120	7-912067-1		↓	-9
↑	↓	↓	↓	36.7	100	7-↑	↑	-0	-8
↑	3	30	70	33.7	90	6-	↑	-9	-7
↑	5	50	43	30.7	80	6-	↑	-8	-6
↑	↑	↑	↑	27.7	70	6-	↑	-7	-5
↑	↑	↑	↑	24.7	60	6-	↑	-6	-4
↑	↑	↑	↑	21.7	50	6-	↑	-5	-3
↑	↑	↑	↑	18.7	40	6-	↑	-4	-2
NOT AVAILABLE	5	50	43	15.7	30	6-912067-3		↓	-2

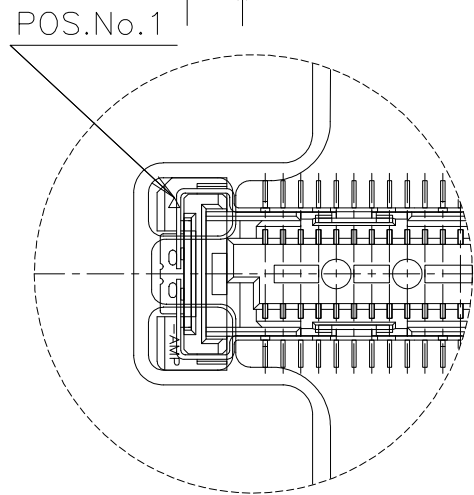

DETAIL C (SCALE 4:1)

4 TRAY TYPE-1 AND TYPE-2 MUST BE PILED UP BY TURNS.  
(REFER TO PACKING SPECIFICATIONS)

GENERAL TOLERANCE  
一般公差

10 ≥ ±0.2  
30 ≥ >10: ±0.25  
100 ≥ >30: ±0.3  
ANGLES: ±3°

THIS DRAWING IS A CONTROLLED DOCUMENT.

DIMENSIONS:  
單位: 耗  
mm

TOLERANCES UNLESS  
OTHERWISE SPECIFIED:  
一般公差

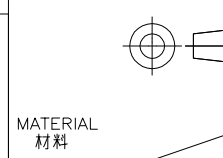

MATERIAL 材料

0 PLC ± -  
1 PLC ± -  
2 PLC ± -  
3 PLC ± -  
4 PLC ± -  
ANGLES ± -  
FINISH 仕上

DWN HAWKING HE 20DEC04  
CHK STEVEN YAO 20DEC04  
APVD I.ENOMOTO 20DEC04  
PRODUCT SPEC 製品規格  
108-60047  
APPLICATION SPEC 取付適用規格  
114-5255  
WEIGHT

**STE** TE Connectivity

SOFT TRAY ASSY  
FH 0.6BTB CONNECTOR  
REC 12H W/G-CONT

NAME 名稱

SIZE CAGE CODE DRAWING NO 番号 RESTRICTED TO

A3 00779 C-5316564

CUSTOMER DRAWING SCALE 1:2 SHEET 1 OF 3 REV A1