

IR2106(4)(S) & (PbF)

HIGH AND LOW SIDE DRIVER

Features

- Floating channel designed for bootstrap operation
Fully operational to +600V
Tolerant to negative transient voltage
dV/dt immune
- Gate drive supply range from 10 to 20V (IR2106(4))
- Undervoltage lockout for both channels
- 3.3V, 5V and 15V input logic compatible
- Matched propagation delay for both channels
- Logic and power ground +/- 5V offset.
- Lower di/dt gate driver for better noise immunity
- Outputs in phase with inputs (IR2106)
- Also available LEAD-FREE

Packages

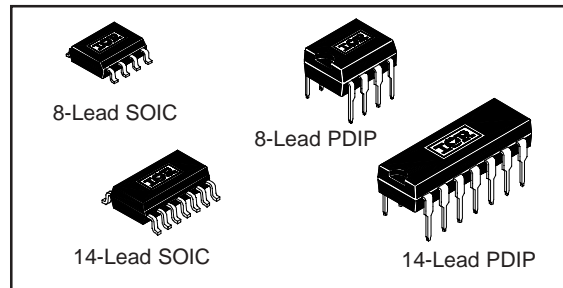

Description

The IR2106(4)(S) are high voltage, high speed power MOSFET and IGBT drivers with independent high and low side referenced output channels. Proprietary HVIC and latch immune CMOS technologies enable ruggedized monolithic construction. The logic input is compatible with standard CMOS or LSTTL output, down to 3.3V logic. The output drivers feature a high pulse current buffer stage designed for minimum driver cross-conduction. The floating channel can be used to drive an N-channel power MOSFET or IGBT in the high side configuration which operates up to 600 volts.

2106/2301//2108//2109/2302/2304 Feature Comparison

Part	Input logic	Cross-conduction prevention logic	Dead-Time	Ground Pins	Ton/Toff
2106/2301	HIN/LIN	no	none	COM	220/200
21064				VSS/COM	
2108	HIN/LIN	yes	Internal 540ns	COM	220/200
21084			Programmable 0.54-5µs	VSS/COM	
2109/2302	IN/SD	yes	Internal 540ns	COM	750/200
21094			Programmable 0.54-5µs	VSS/COM	
2304	HIN/LIN	yes	Internal 100ns	COM	160/140

Typical Connection

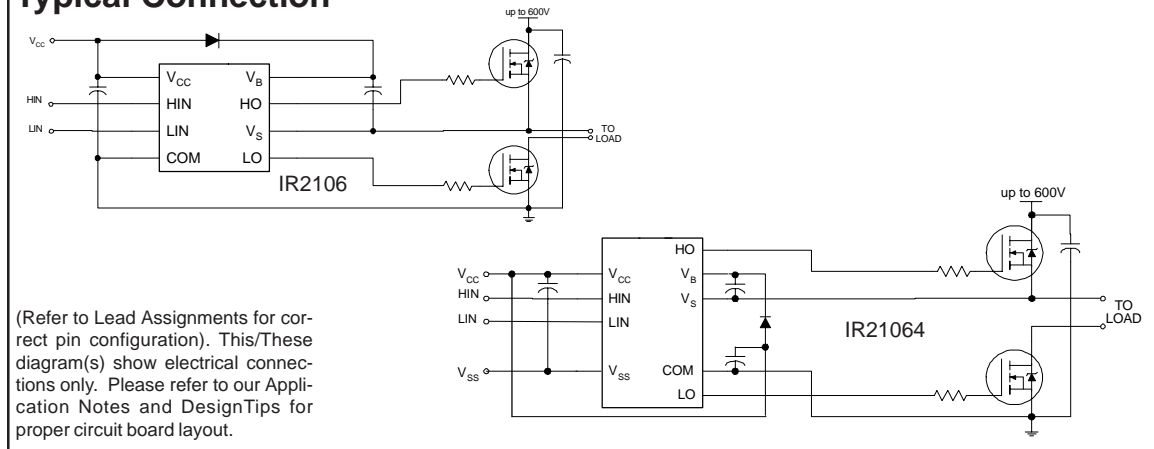

Absolute Maximum Ratings

Absolute maximum ratings indicate sustained limits beyond which damage to the device may occur. All voltage parameters are absolute voltages referenced to COM. The thermal resistance and power dissipation ratings are measured under board mounted and still air conditions.

Symbol	Definition	Min.	Max.	Units	
V _B	High side floating absolute voltage	-0.3	625	V	
V _S	High side floating supply offset voltage	V _B - 25	V _B + 0.3		
V _{HO}	High side floating output voltage	V _S - 0.3	V _B + 0.3		
V _{CC}	Low side and logic fixed supply voltage	-0.3	25		
V _{LO}	Low side output voltage	-0.3	V _{CC} + 0.3		
V _{IN}	Logic input voltage	V _{SS} - 0.3	V _{CC} + 0.3		
V _{SS}	Logic ground (IR21064 only)	V _{CC} - 25	V _{CC} + 0.3		
dV _S /dt	Allowable offset supply voltage transient	—	50	V/ns	
P _D	Package power dissipation @ T _A ≤ +25°C	(8 lead PDIP)	—	1.0	W
		(8 lead SOIC)	—	0.625	
		(14 lead PDIP)	—	1.6	
		(14 lead SOIC)	—	1.0	
R _{thJA}	Thermal resistance, junction to ambient	(8 lead PDIP)	—	125	°C/W
		(8 lead SOIC)	—	200	
		(14 lead PDIP)	—	75	
		(14 lead SOIC)	—	120	
T _J	Junction temperature	—	150	°C	
T _S	Storage temperature	-50	150		
T _L	Lead temperature (soldering, 10 seconds)	—	300		

Recommended Operating Conditions

The Input/Output logic timing diagram is shown in figure 1. For proper operation the device should be used within the recommended conditions. The V_S and V_{SS} offset rating are tested with all supplies biased at 15V differential.

Symbol	Definition	Min.	Max.	Units
V_B	High side floating supply absolute voltage IR2106(4)	$V_S + 10$	$V_S + 20$	V
V_S	High side floating supply offset voltage	Note 1	600	
V_{HO}	High side floating output voltage	V_S	V_B	
V_{CC}	Low side and logic fixed supply voltage IR2106(4)	10	20	
V_{LO}	Low side output voltage	0	V_{CC}	
V_{IN}	Logic input voltage	V_{SS}	V_{CC}	
V_{SS}	Logic ground (IR21064 only)	-5	5	
T_A	Ambient temperature	-40	125	°C

Note 1: Logic operational for V_S of -5 to +600V. Logic state held for V_S of -5V to $-V_{BS}$. (Please refer to the Design Tip DT97-3 for more details).

Dynamic Electrical Characteristics

$V_{BIAS} (V_{CC}, V_{BS}) = 15V$, $V_{SS} = COM$, $C_L = 1000 pF$, $T_A = 25^\circ C$.

Symbol	Definition	Min.	Typ.	Max.	Units	Test Conditions
t_{on}	Turn-on propagation delay	—	220	300	nsec	$V_S = 0V$
t_{off}	Turn-off propagation delay	—	200	280		$V_S = 0V$ or 600V
MT	Delay matching, HS & LS turn-on/off	—	0	30		
t_r	Turn-on rise time	—	150	220		$V_S = 0V$
t_f	Turn-off fall time	—	50	80		$V_S = 0V$

IR2106(4)(S) & (PBF)

Static Electrical Characteristics

V_{BIAS} (V_{CC} , V_{BS}) = 15V, V_{SS} = COM and T_A = 25°C unless otherwise specified. The V_{IL} , V_{IH} and I_{IN} parameters are referenced to V_{SS}/COM and are applicable to the respective input leads. The V_O , I_O and R_{on} parameters are referenced to COM and are applicable to the respective output leads: HO and LO.

Symbol	Definition	Min.	Typ.	Max.	Units	Test Conditions
V_{IH}	Logic "1" input voltage (IR2106(4))	2.9	—	—	V	$V_{CC} = 10V$ to 20V
V_{IL}	Logic "0" input voltage (IR2106(4))	—	—	0.8		$V_{CC} = 10V$ to 20V
V_{OH}	High level output voltage, $V_{BIAS} - V_O$	—	0.8	1.4		$I_O = 20$ mA
V_{OL}	Low level output voltage, V_O	—	0.3	0.6		$I_O = 20$ mA
I_{LK}	Offset supply leakage current	—	—	50	μA	$V_B = V_S = 600V$
I_{QBS}	Quiescent V_{BS} supply current	20	75	130		$V_{IN} = 0V$ or 5V
I_{QCC}	Quiescent V_{CC} supply current	60	120	180		$V_{IN} = 0V$ or 5V
I_{IN+}	Logic "1" input bias current $V_{IN} = 5V$ (IR2106(4))	—	5	20		
I_{IN-}	Logic "0" input bias current $V_{IN} = 0V$ (IR2106(4))	—	—	2		
V_{CCUV+} V_{BSUV+}	V_{CC} and V_{BS} supply undervoltage positive going threshold	8.0	8.9	9.8	V	
V_{CCUV-} V_{BSUV-}	V_{CC} and V_{BS} supply undervoltage negative going threshold	7.4	8.2	9.0		
V_{CCUVH} V_{BSUVH}	Hysteresis	0.3	0.7	—		
I_{O+}	Output high short circuit pulsed current	120	200	—	mA	$V_O = 0V$, $PW \leq 10 \mu s$
I_{O-}	Output low short circuit pulsed current	250	350	—		$V_O = 15V$, $PW \leq 10 \mu s$

IR2106(4)(S) & (PBF)

Lead Definitions

Symbol	Description
HIN	Logic input for high side gate driver output (HO), in phase
LIN	Logic input for low side gate driver output (LO), in phase
VSS	Logic Ground (IR21064 only)
V _B	High side floating supply
HO	High side gate drive output
V _S	High side floating supply return
V _{CC}	Low side and logic fixed supply
LO	Low side gate drive output
COM	Low side return

Lead Assignments

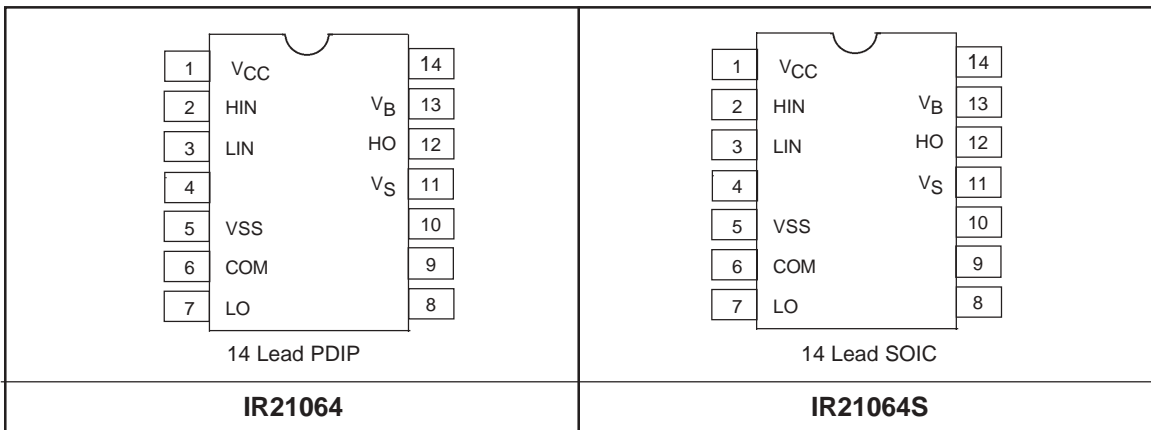
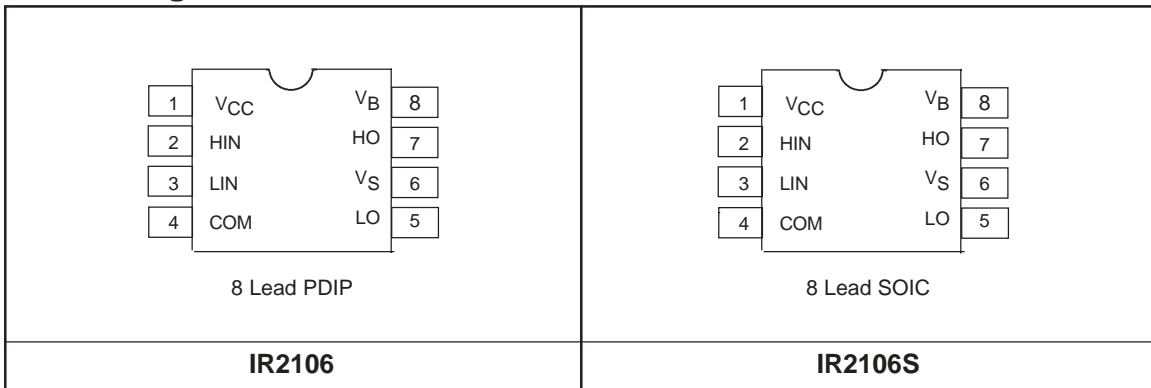

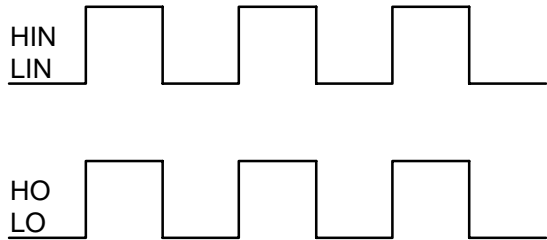

Figure 1. Input/Output Timing Diagram

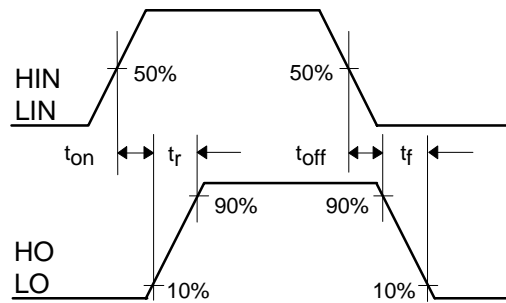

Figure 2. Switching Time Waveform Definitions

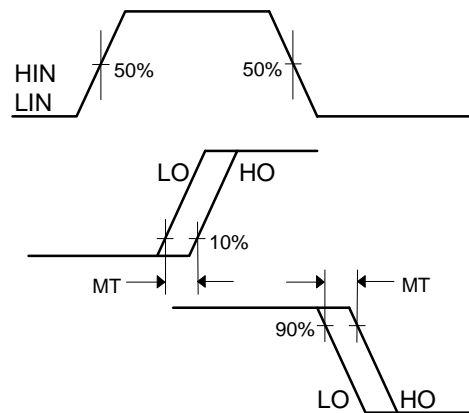

Figure 3. Delay Matching Waveform Definitions

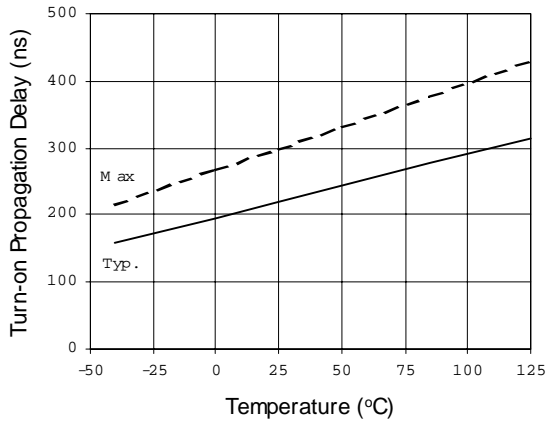

Figure 4A. Turn-on Propagation Delay vs. Temperature

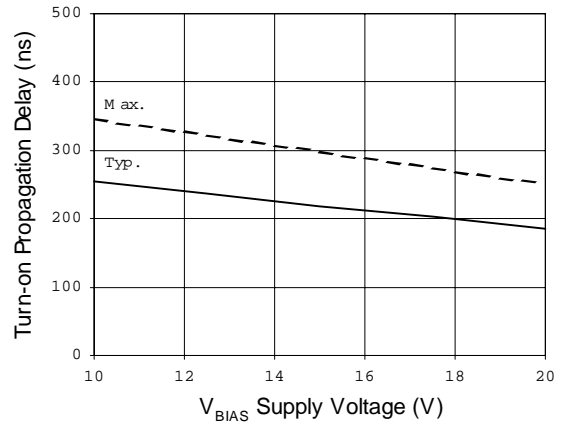

Figure 4B. Turn-on Propagation Delay vs. Supply Voltage

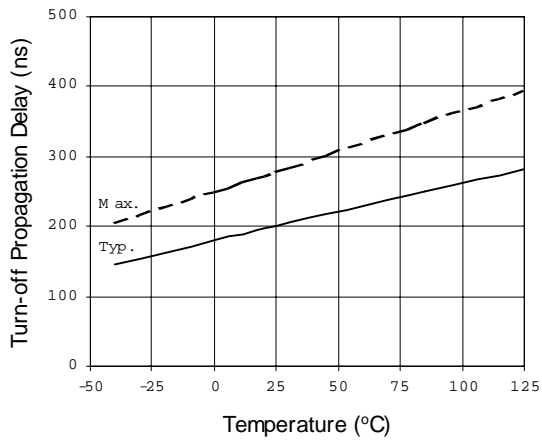

Figure 5A. Turn-off Propagation Delay vs. Temperature

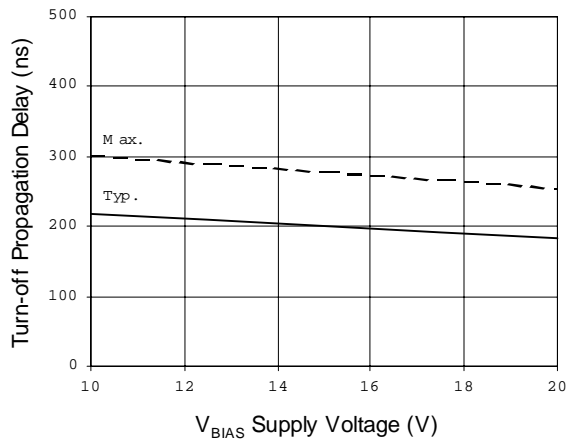

Figure 5B. Turn-off Propagation Delay vs. Supply Voltage

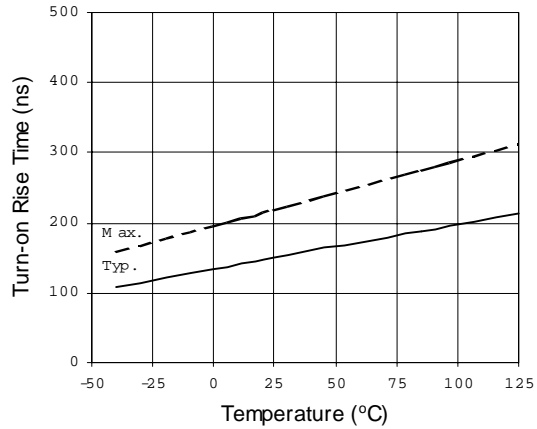

Figure 6A. Turn-on Rise Time vs. Temperature

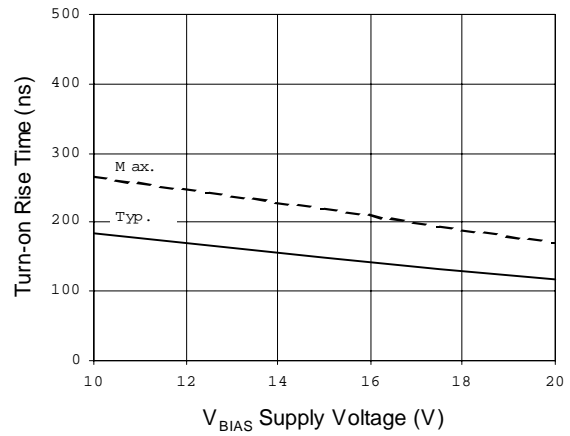

Figure 6B. Turn-on Rise Time vs. Supply Voltage

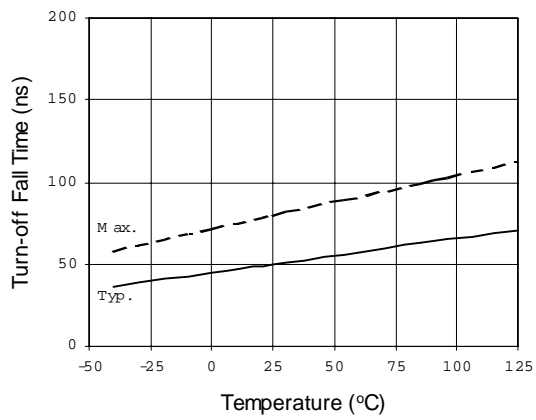

Figure 7A. Turn-off Fall Time vs. Temperature

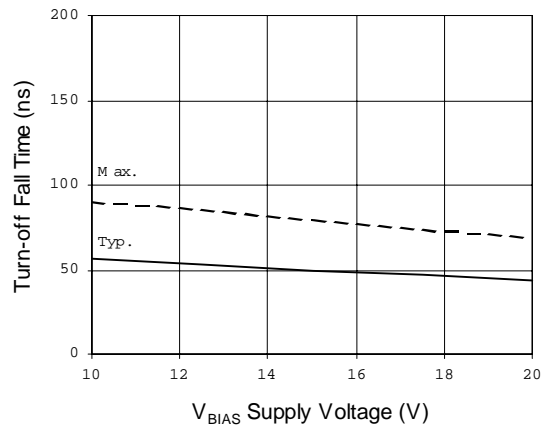

Figure 7B. Turn-off Fall Time vs. Supply Voltage

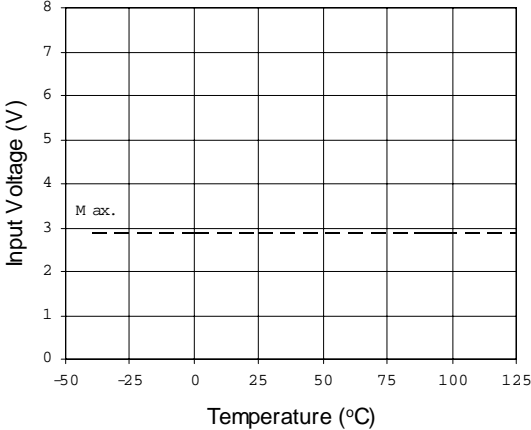

Figure 8A. Logic "1" Input Voltage vs. Temperature

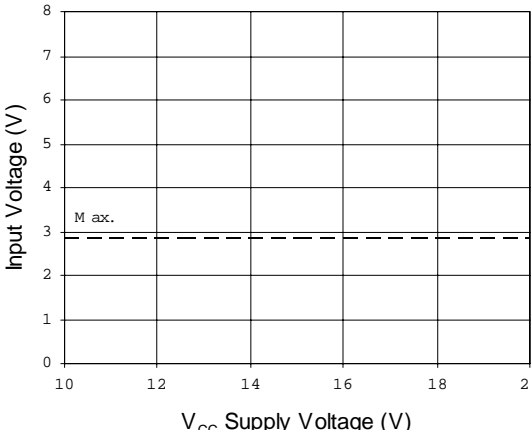

Figure 8B. Logic "1" Input Voltage vs. Supply Voltage

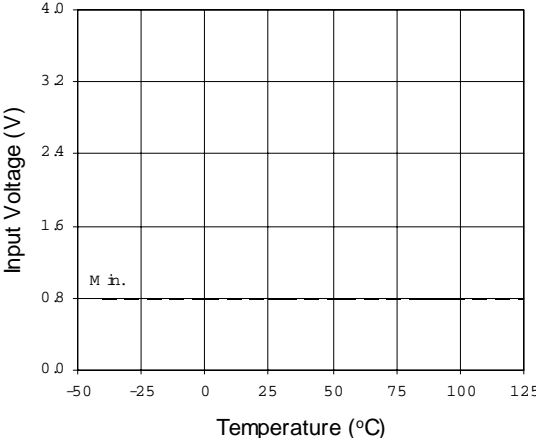

Figure 9A. Logic "0" Input Voltage vs. Temperature

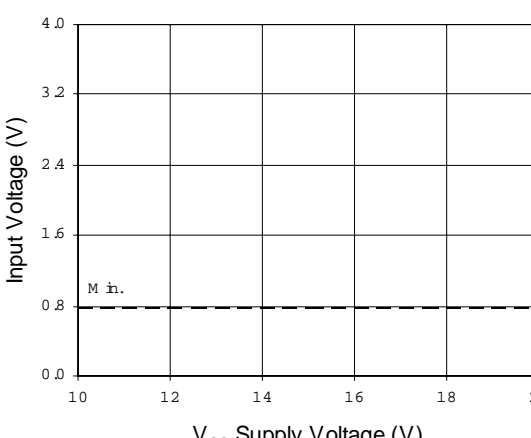

Figure 9B. Logic "0" Input Voltage vs. Supply Voltage

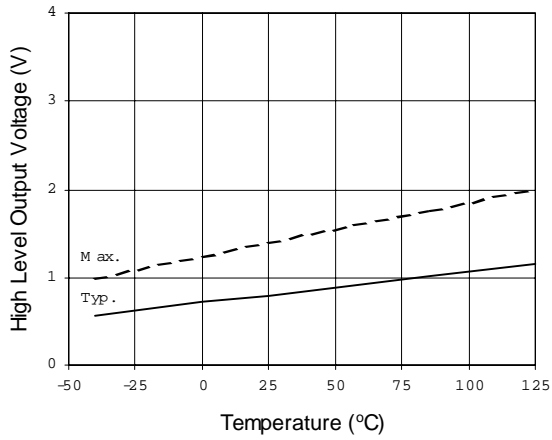

Figure 10A. High Level Output Voltage vs. Temperature

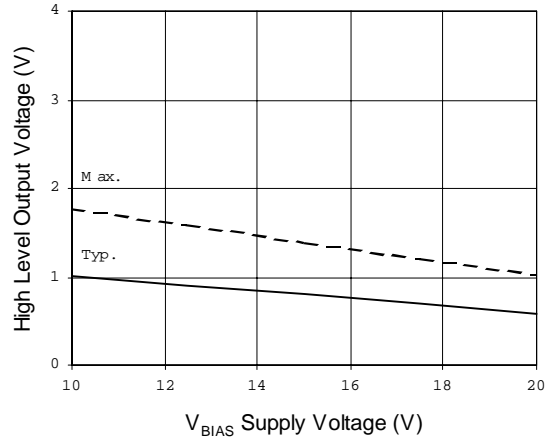

Figure 10B. High Level Output Voltage vs. Supply Voltage

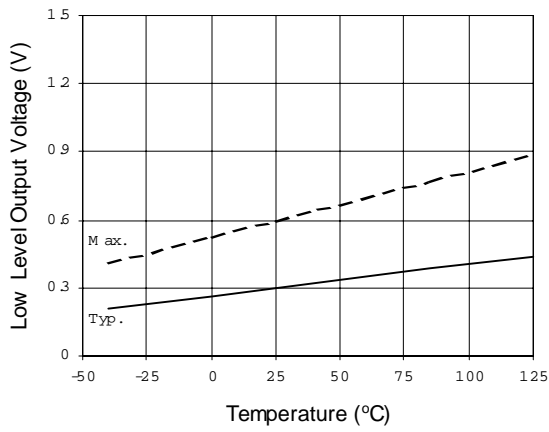

Figure 11A. Low Level Output Voltage vs. Temperature

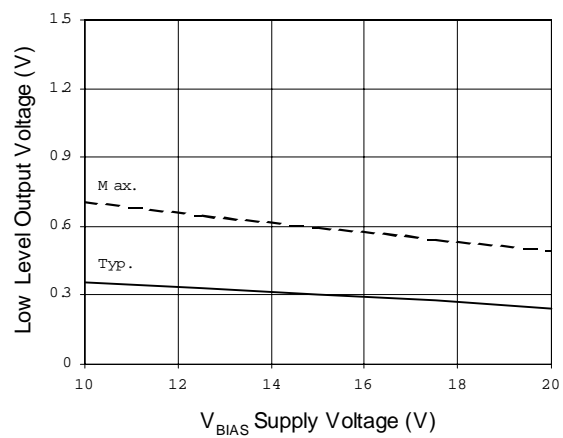

Figure 11B. Low Level Output Voltage vs. Supply Voltage

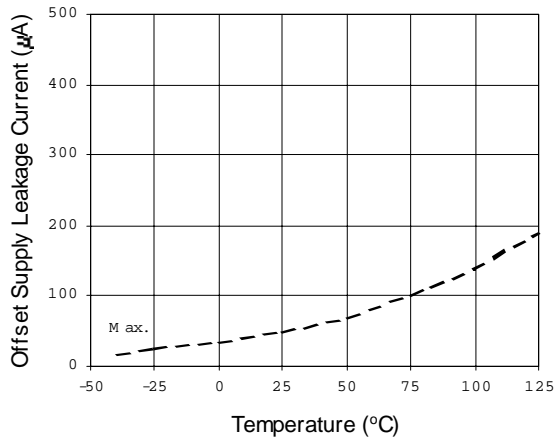

Figure 12A. Offset Supply Leakage Current vs. Temperature

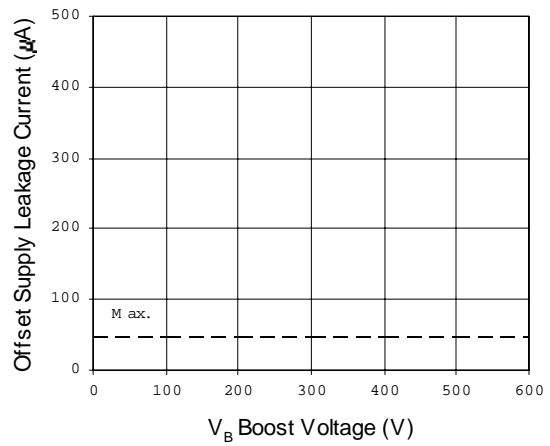

Figure 12B. Offset Supply Leakage Current vs. Supply Voltage

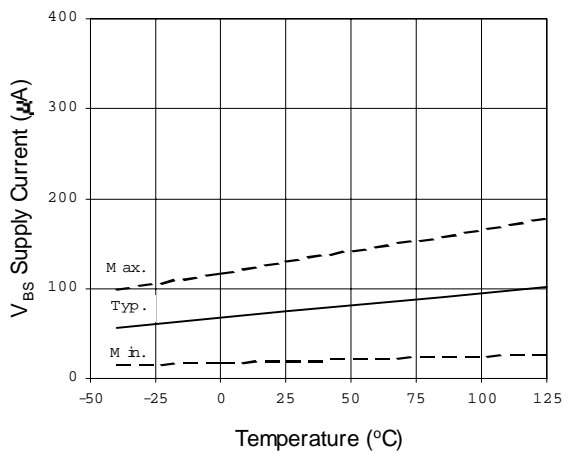

Figure 13A. V_{BS} Supply Current vs. Temperature

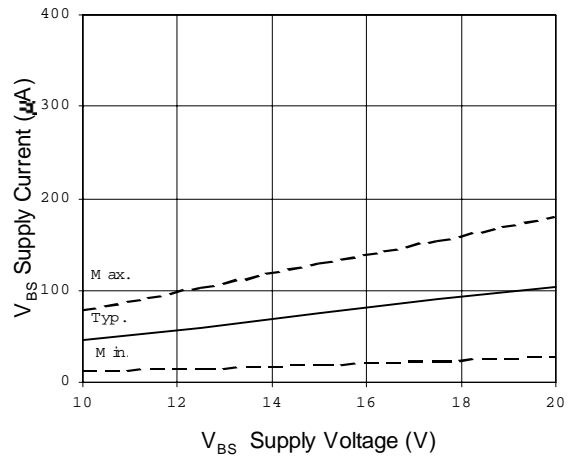

Figure 13B. V_{BS} Supply Current vs. Supply Voltage

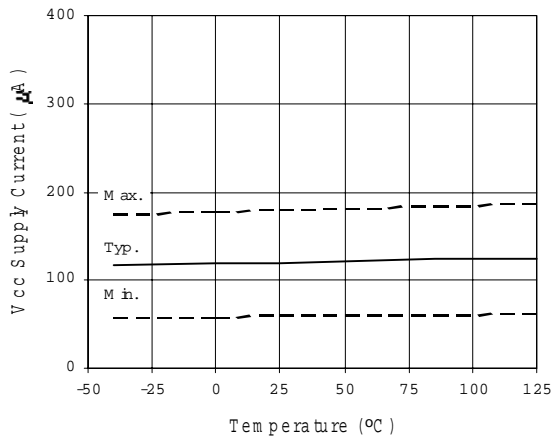

Figure 14A. Quiescent V_{CC} Supply Current vs. Temperature

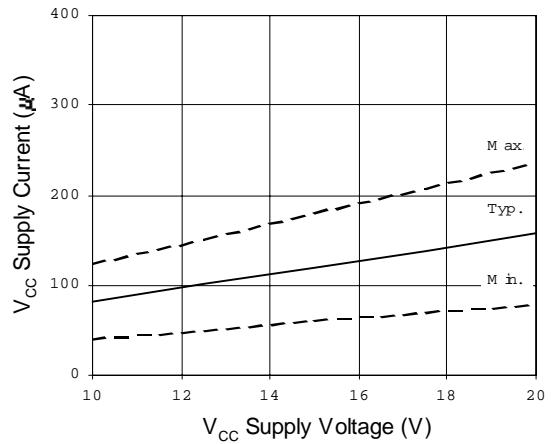

Figure 14B. Quiescent V_{CC} Supply Current vs. V_{CC} Supply Voltage

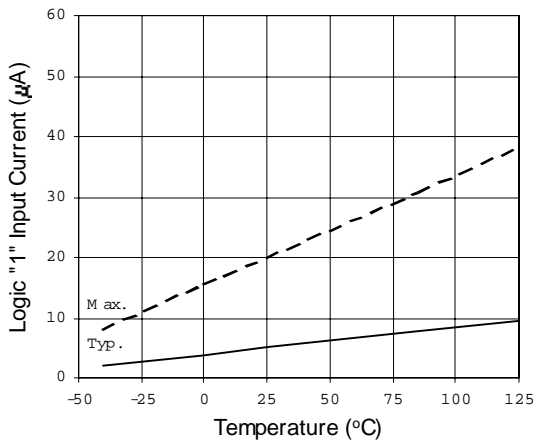

Figure 15A. Logic "1" Input Current vs. Temperature

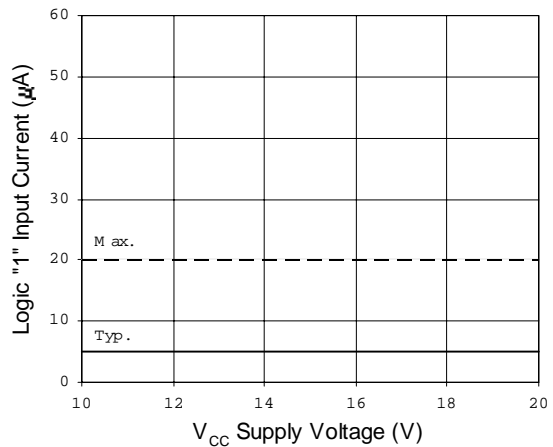

Figure 15B. Logic "1" Bias Current vs. Supply Voltage

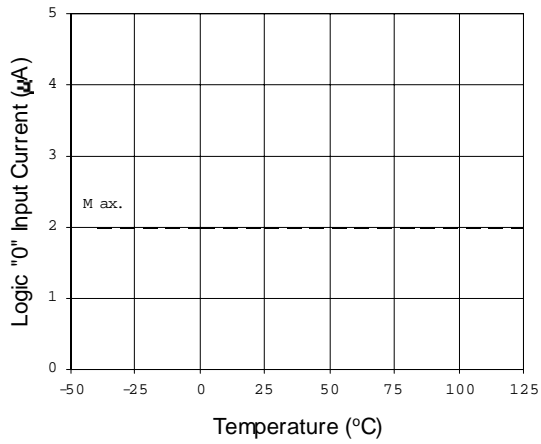

Figure 16A. Logic "0" Input Current vs. Temperature

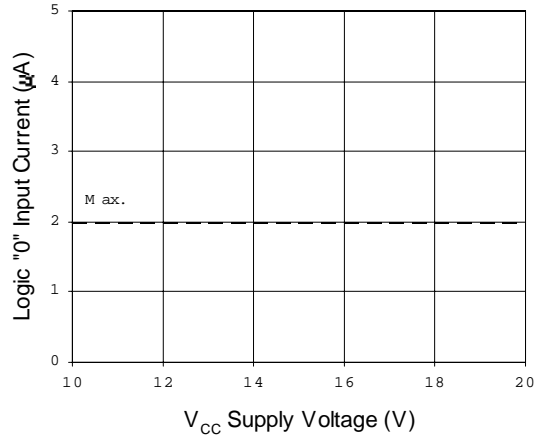

Figure 16B. Logic "0" Input Current vs. Supply Voltage

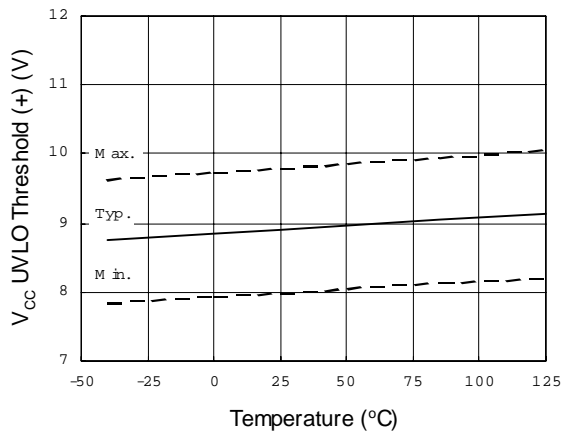

Figure 17. V_{CC} Undervoltage Threshold (+) vs. Temperature

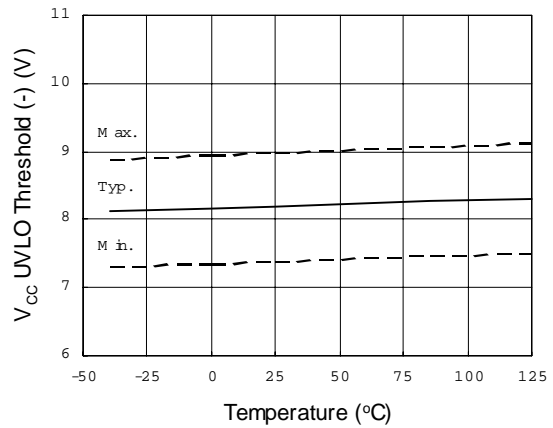

Figure 18. V_{CC} Undervoltage Threshold (-) vs. Temperature

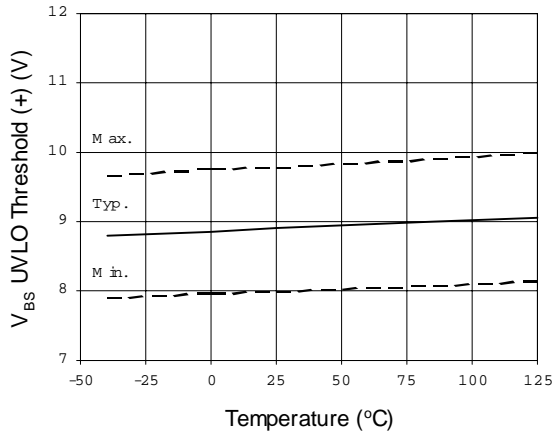

Figure 19. V_{BS} Undervoltage Threshold (+) vs. Temperature

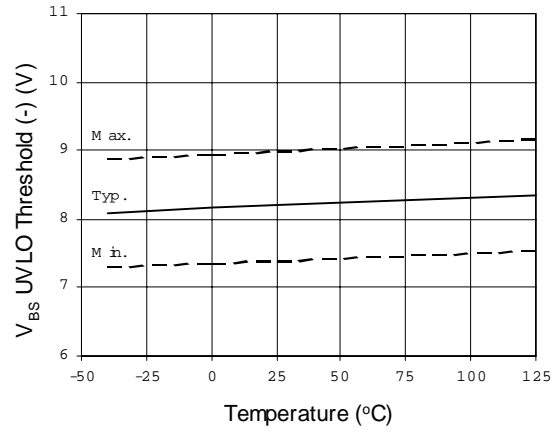

Figure 20. V_{BS} Undervoltage Threshold (-) vs. Temperature

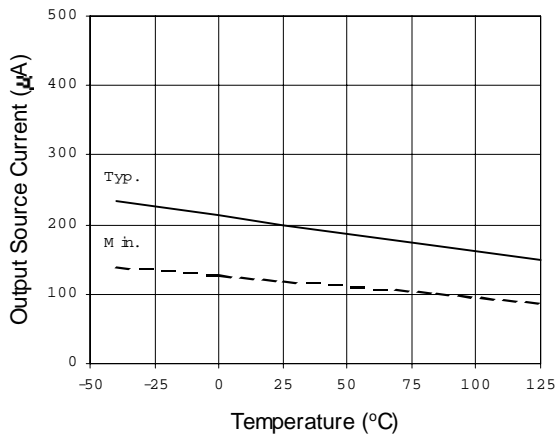

Figure 21A. Output Source Current vs. Temperature

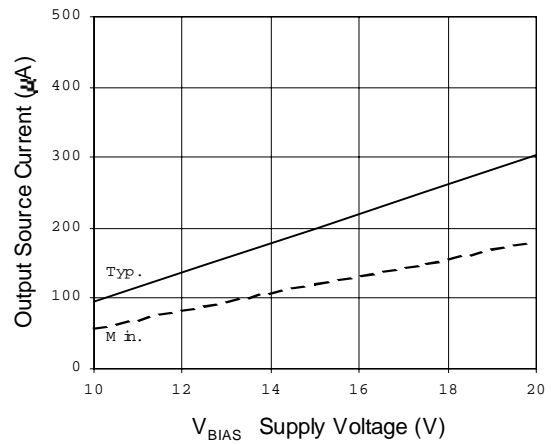

Figure 21B. Output Source Current vs. Supply Voltage

IR2106(4)(S) & (PBF)

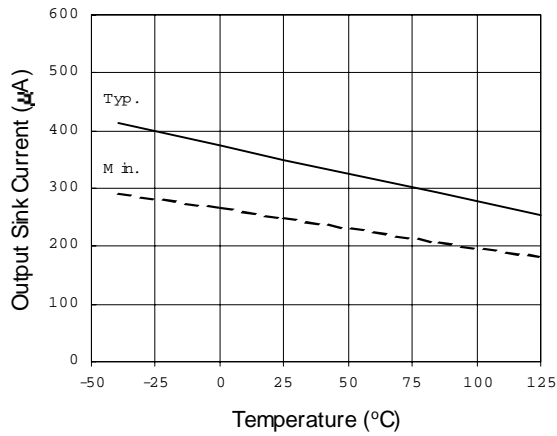

Figure 22A. Output Sink Current vs. Temperature

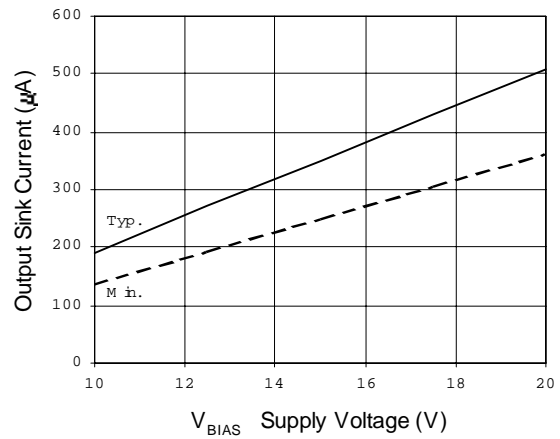

Figure 22B. Output Sink Current vs. Supply Voltage

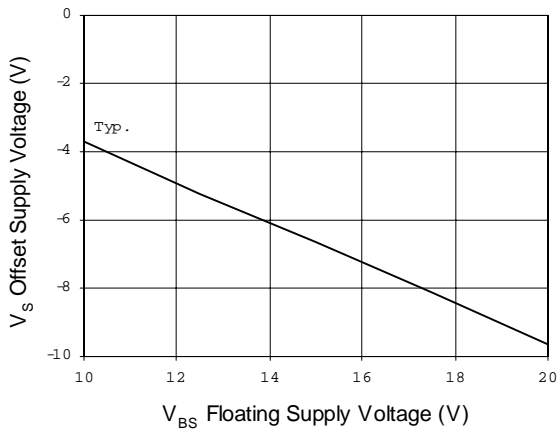

Figure 23. Maximum V_S Negative Offset vs. Supply Voltage

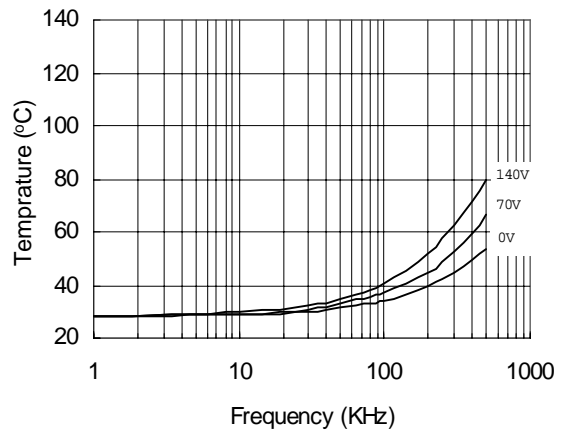

Figure 24. IR2106 vs. Frequency (IRFBC20), R_{gate}=33Ω, V_{CC}=15V

IR2106(4)(S & (PbF))

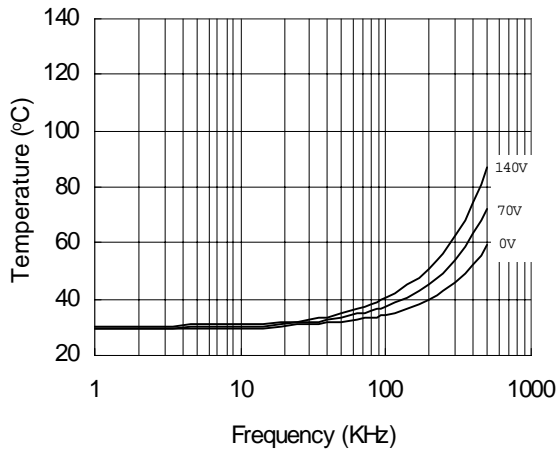

Figure 25. IR2106 vs. Frequency (IRFBC30),
 $R_{gate}=22\Omega$, $V_{CC}=15V$

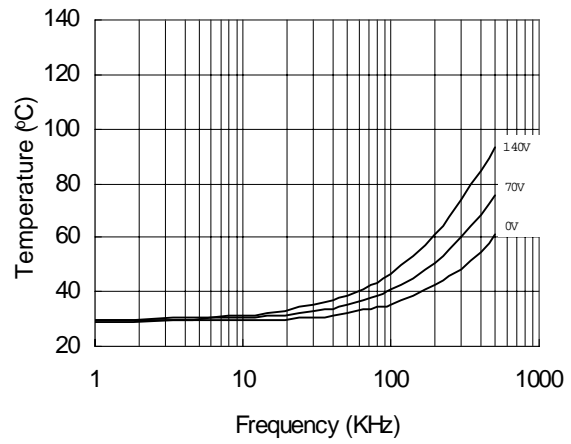

Figure 26. IR2106 vs. Frequency (IRFBC40),
 $R_{gate}=15\Omega$, $V_{CC}=15V$

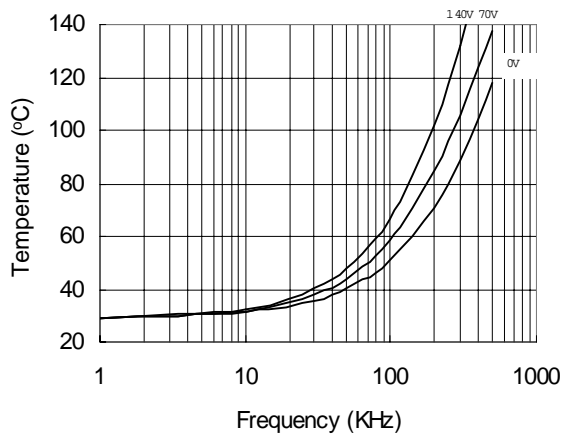

Figure 27. IR2106 vs. Frequency (IRFPE50),
 $R_{gate}=10\Omega$, $V_{CC}=15V$

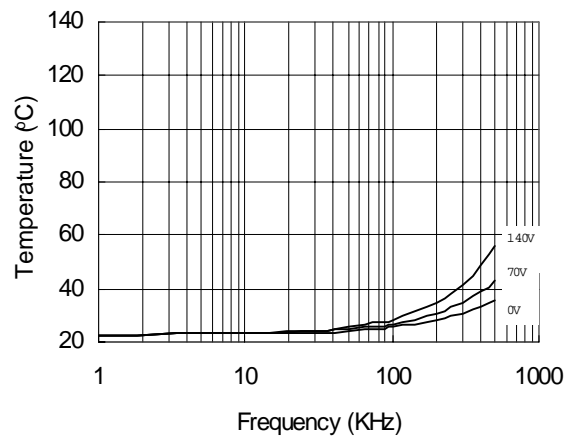

Figure 28. IR21064 vs. Frequency (IRFBC20),
 $R_{gate}=33\Omega$, $V_{CC}=15V$

IR2106(4)(S) & (PBF)

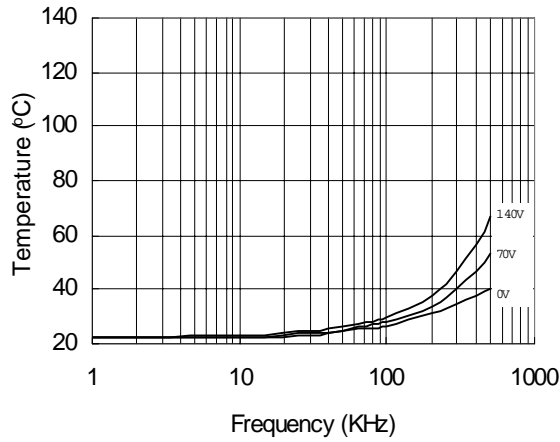

Figure 29. IR21064 vs. Frequency (IRFBC30),
 $R_{gate}=22\Omega$, $V_{CC}=15V$

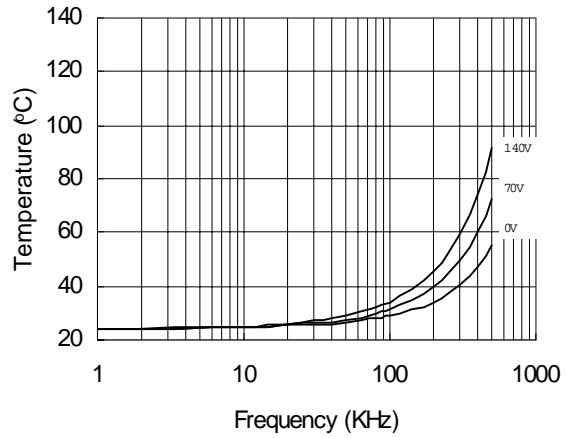

Figure 30. IR21064 vs. Frequency (IRFBC40),
 $R_{gate}=15\Omega$, $V_{CC}=15V$

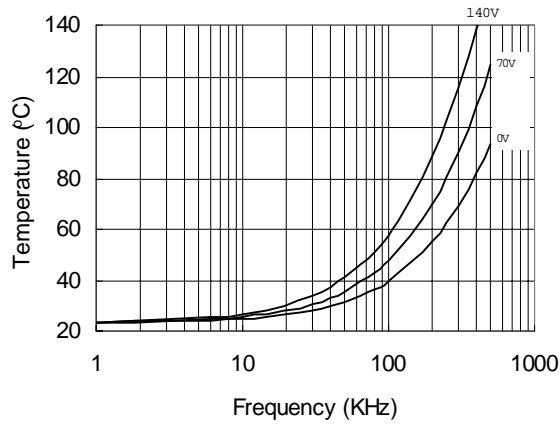

Figure 31. IR21064 vs. Frequency (IRFPE50),
 $R_{gate}=10\Omega$, $V_{CC}=15V$

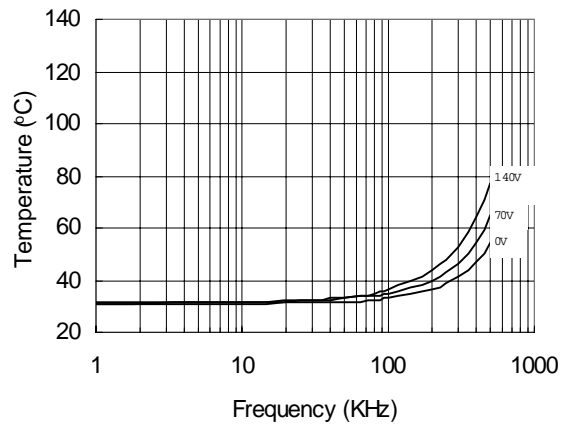

Figure 32. IR2106S vs. Frequency (IRFBC20),
 $R_{gate}=33\Omega$, $V_{CC}=15V$

IR2106(4)(S & (PbF))

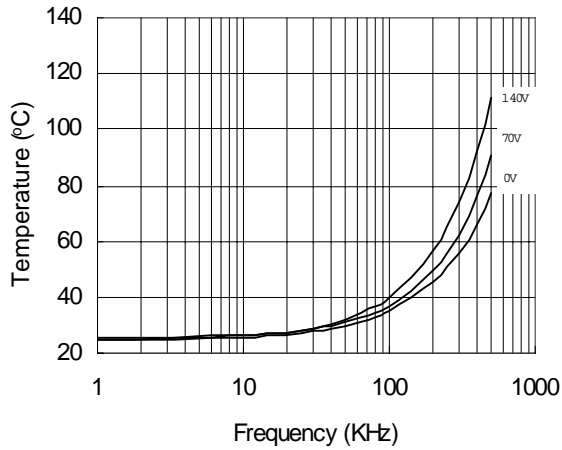

Figure 33. IR2106S vs. Frequency (IRFBC30),
 $R_{gate}=22\Omega$, $V_{cc}=15V$

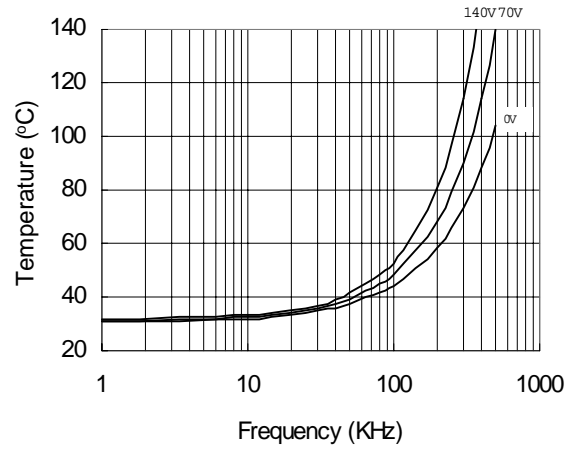

Figure 34. IR2106S vs. Frequency (IRFBC40),
 $R_{gate}=15\Omega$, $V_{cc}=15V$

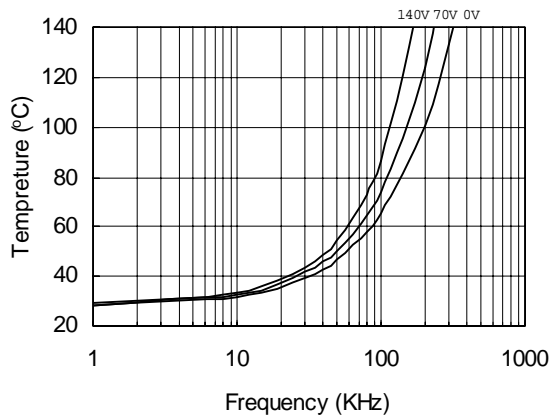

Figure 35. IR2106S vs. Frequency
(IRFPE50), $R_{gate}=10\Omega$, $V_{cc}=15V$

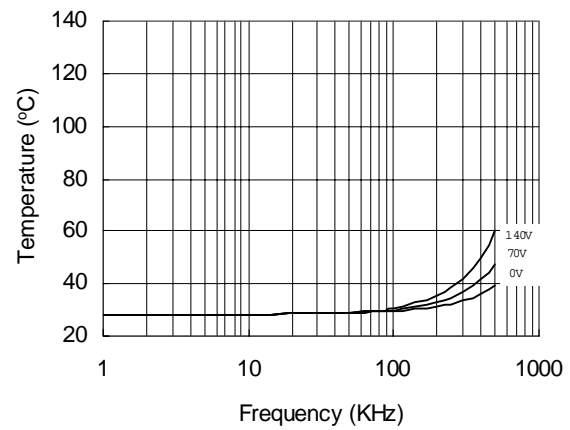

Figure 36. IR21064S vs. Frequency (IRFBC20),
 $R_{gate}=33\Omega$, $V_{cc}=15V$

IR2106(4)(S) & (PBF)

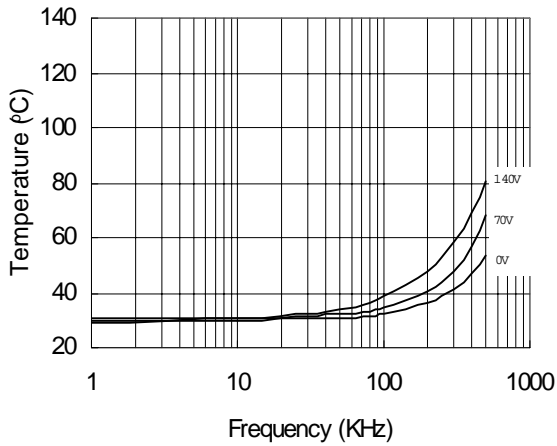

Figure 37. IR21064S vs. Frequency (IRFBC30),
 $R_{gate}=22\Omega$, $V_{CC}=15V$

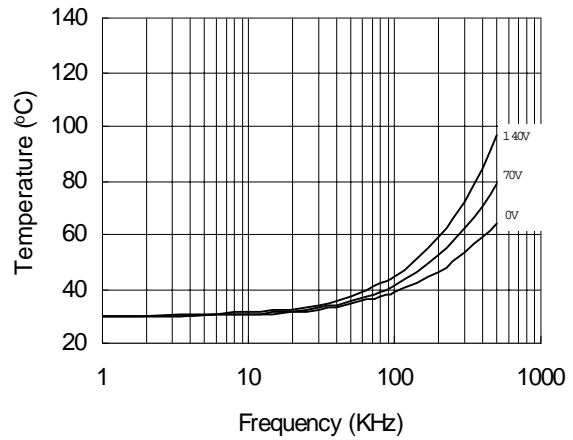

Figure 38. IR21064S vs. Frequency (IRFBC40),
 $R_{gate}=15\Omega$, $V_{CC}=15V$

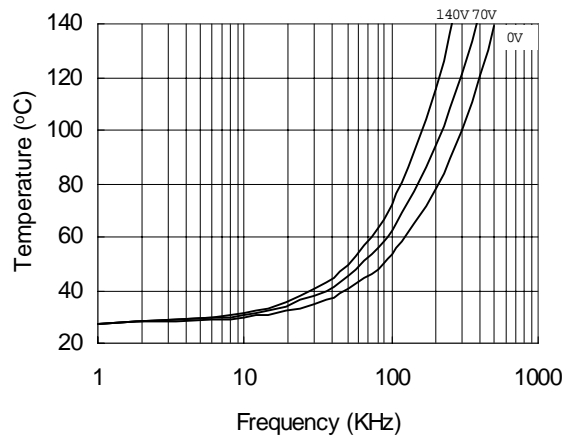
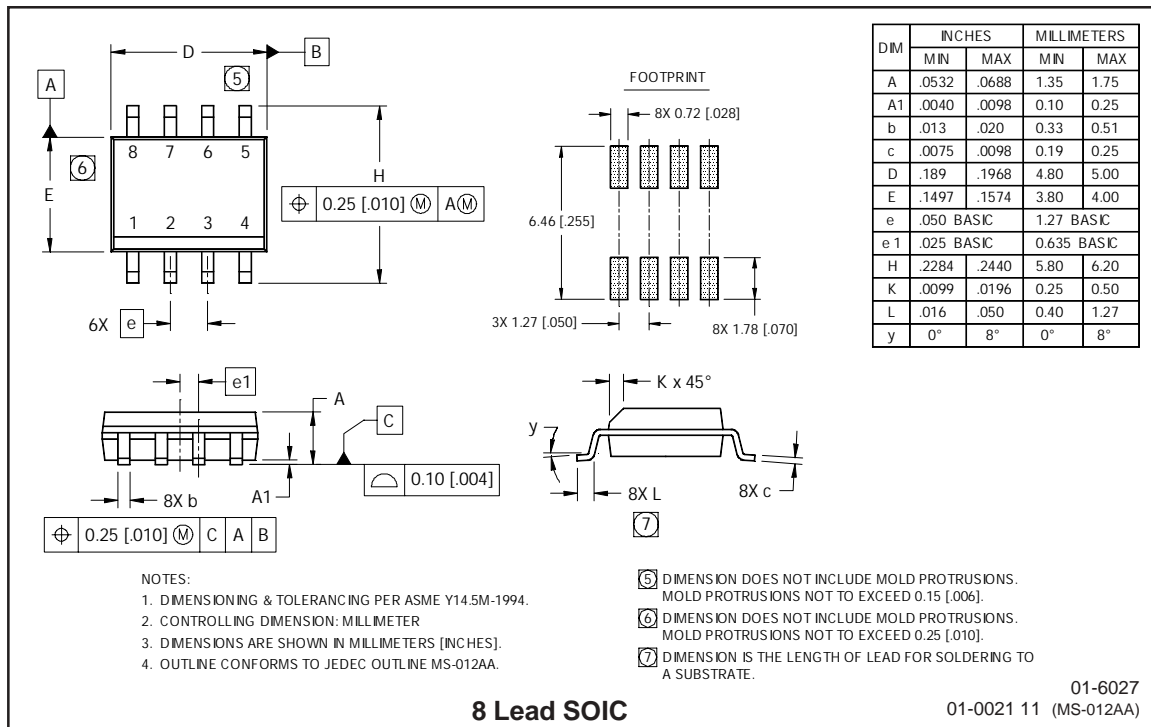
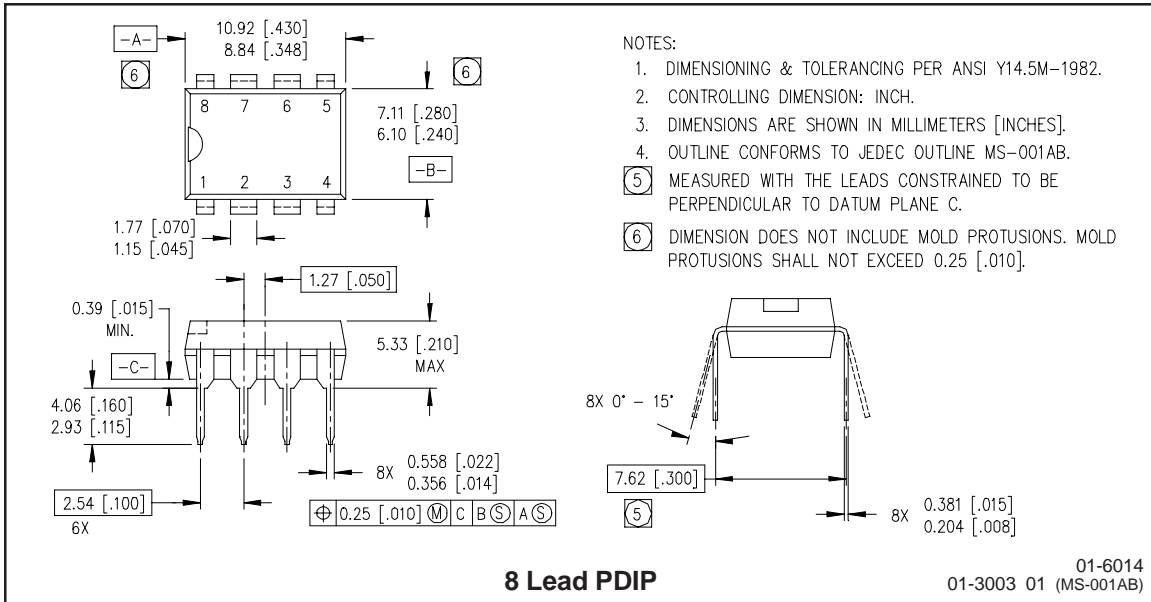

Figure 39. IR21064S vs. Frequency (IRFPE50),
 $R_{gate}=10\Omega$, $V_{CC}=15V$

Case Outlines



IR2106(4)(S) & (PBF)

International
IR Rectifier

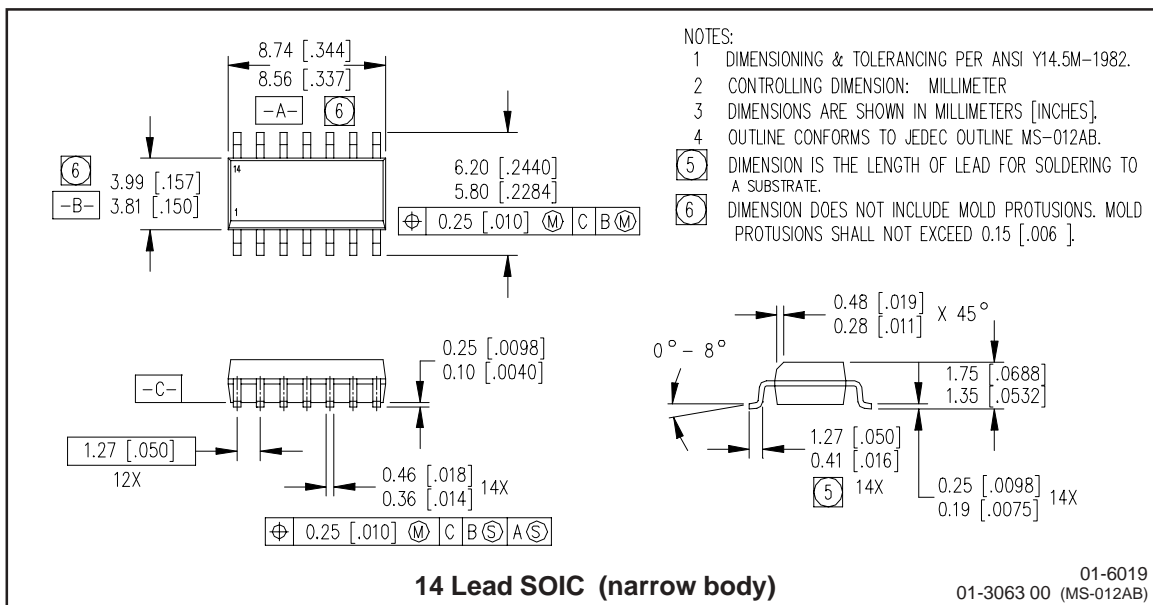
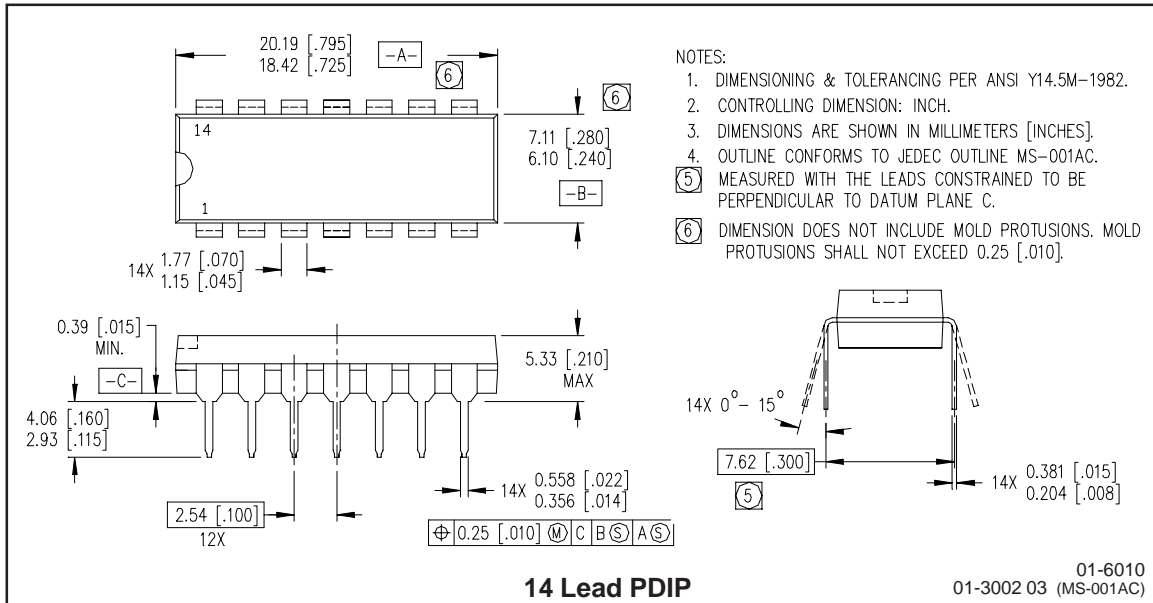

LEADFREE PART MARKING INFORMATION

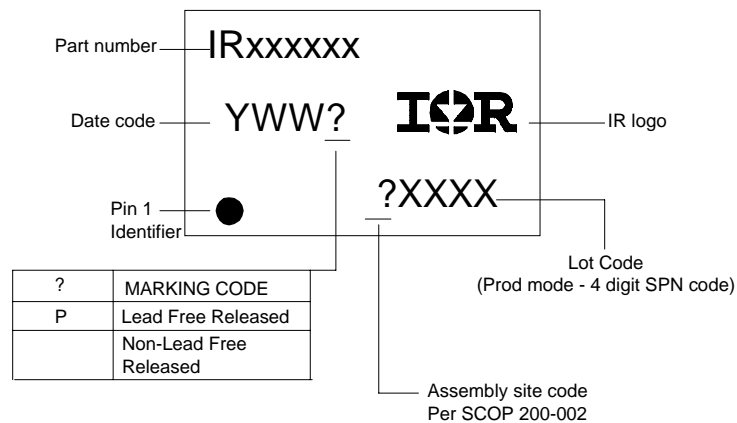

ORDER INFORMATION

Basic Part (Non-Lead Free)

8-Lead PDIP IR2106 order IR2106
 8-Lead SOIC IR2106S order IR2106S
 14-Lead PDIP IR21064 order IR21064
 14-Lead SOIC IR21064S order IR21064S

Leadfree Part

8-Lead PDIP IR2106 order IR2106PbF
 8-Lead SOIC IR2106S order IR2106SPbF
 14-Lead PDIP IR21064 order IR21064PbF
 14-Lead SOIC IR21064S order IR21064SPbF