

# HA1630S07

R03DS0083EJ0200

Rev.2.00

## Single CMOS High Drive Operational Amplifier

Jan 10, 2014

### Description

HA1630S07 is a low power single CMOS operational amplifier featuring high output current with typical current supply of 60  $\mu$ A (2.7 V to 5.5 V). This IC designed to operate from a single power supply and have full swing outputs. Available in CMPAK-5 and MPAK-5 package, the miniature size of this IC not only allows compact integration in portable devices but also minimizes distance of signal sources (sensors), thus reducing external noise pick up prior to amplification. This IC exhibit excellent current drive-power ratio capable of 2 k $\Omega$  load driving and yet resistant to oscillation for capacitive loads up to 200 pF.

### Features

- Low supply current  $I_{DD} = 60 \mu\text{A Typ (}V_{DD} = 3 \text{ V, }R_L = \text{No load)}$
- Low voltage operation  $V_{DD} = 2.7 \text{ V to } 5.5 \text{ V}$
- Low input offset voltage  $V_{IO} = 6 \text{ mV Max}$
- Low input bias current  $I_{IB} = 1 \text{ pA Typ}$
- High output current  $I_{OSOURCE} = 15 \text{ mA Typ (}V_{DD} = 3.0 \text{ V, }V_{OH} = 2.5 \text{ V)}$   
 $I_{OSINK} = 15 \text{ mA Typ (}V_{DD} = 3.0 \text{ V, }V_{OL} = 0.5 \text{ V)}$
- Input common voltage range includes ground

### Ordering Information

Part No.	Package Name	Package Code
HA1630S07CM	CMPAK-5	PTSP0005ZC-A
HA1630S07LP	MPAK-5	PLSP0005ZB-A

## Pin Arrangement

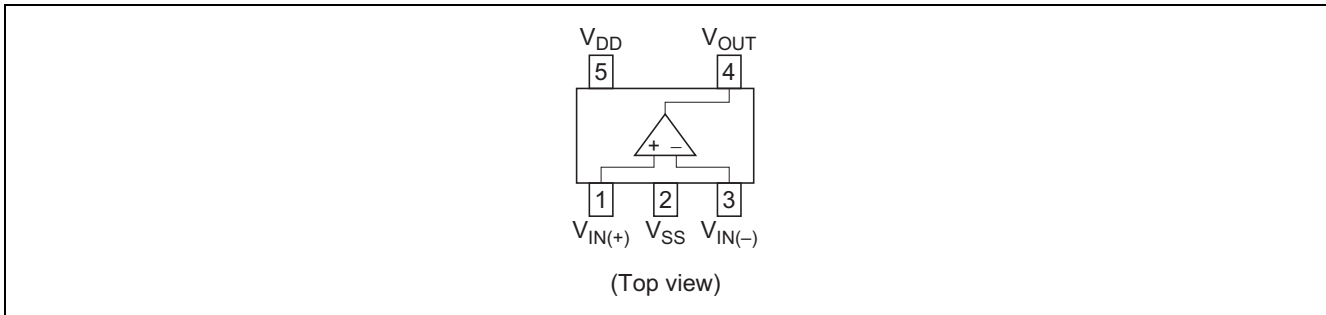

## Equivalent Circuit

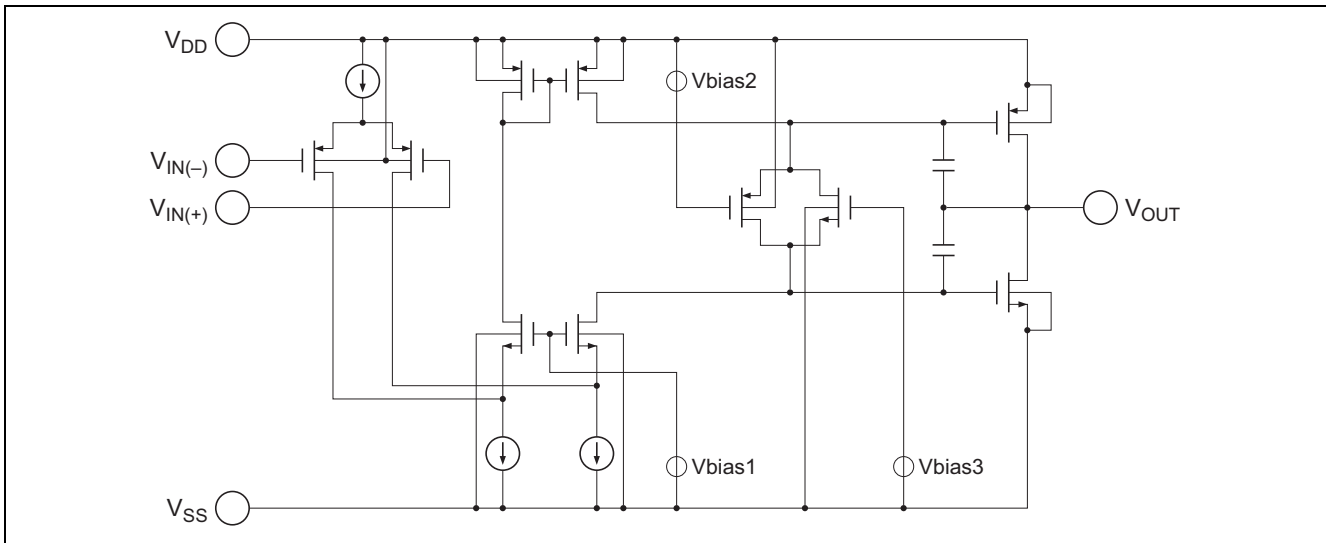

## Absolute Maximum Ratings

(Ta = 25°C)

Item	Symbol	Ratings	Unit	Note
Supply voltage	V <sub>DD</sub>	7.0	V	
Differential input voltage	V <sub>IN(diff)</sub>	-V <sub>DD</sub> to +V <sub>DD</sub>	V	1
Input voltage	V <sub>IN</sub>	-0.1 to +V <sub>DD</sub>	V	
Output current	I <sub>OUT</sub>	40	mA	
Power dissipation	P <sub>T</sub>	80 (CMPAK-5)	mW	2
		120 (MPAK-5)		
Operating temperature	T <sub>opr</sub>	-40 to +85	°C	
Storage temperature	T <sub>stg</sub>	-55 to +125	°C	

Note: 1. Do not apply input voltage exceeding V<sub>DD</sub> or 7 V.

2. If Ta > 25°C,

CMPAK-5: -0.8 mW/°C

MPAK-5: -1.2 mW/°C

## Electrical Characteristics

### DC Characteristics

(Ta = 25°C, V<sub>DD</sub> = 3.0 V, V<sub>SS</sub> = 0 V)

Item	Symbol	Min	Typ	Max	Unit	Test Conditions
Input offset voltage	V <sub>IO</sub>	—	—	6	mV	V <sub>IN</sub> = 1.5 V, R <sub>L</sub> = 1 MΩ
Input bias current	I <sub>IB</sub>	—	(1)	—	pA	V <sub>IN</sub> = 1.5 V
Input offset current	I <sub>IO</sub>	—	(1)	—	pA	V <sub>IN</sub> = 1.5 V
Common mode input voltage range	V <sub>CM</sub>	-0.1	—	1.8	V	
Supply current	I <sub>DD</sub>	—	60	170	μA	V <sub>IN(+)</sub> = 1.0 V, R <sub>L</sub> = ∞
Output source current	I <sub>OSOURCE</sub>	7.5	15	—	mA	V <sub>OUT</sub> = 2.5 V
Output sink current	I <sub>OSINK</sub>	7.5	15	—	mA	V <sub>OUT</sub> = 0.5 V
Open loop voltage gain	A <sub>V</sub>	55	80	—	dB	R <sub>L</sub> = 100 kΩ
Common mode rejection ratio	CMRR	50	80	—	dB	V <sub>IN1</sub> = 0 V, V <sub>IN2</sub> = 1.8 V
Power supply rejection ratio	PSRR	55	80	—	dB	V <sub>DD1</sub> = 2.7 V, V <sub>DD2</sub> = 5.5 V
Output high voltage	V <sub>OH</sub>	2.9	—	—	V	R <sub>L</sub> = 2 kΩ to V <sub>SS</sub>
Output low voltage	V <sub>OL</sub>	—	—	0.1	V	R <sub>L</sub> = 2 kΩ to V <sub>DD</sub>

Note: ( ) : Design specification

### AC Characteristics

(Ta = 25°C, V<sub>DD</sub> = 3.0 V, V<sub>SS</sub> = 0 V)

Item	Symbol	Min	Typ	Max	Unit	Test Conditions
Slew rate	SR <sub>r</sub>	—	(1)	—	V/μs	V <sub>IN</sub> = 1.5 V, C <sub>L</sub> = 15 pF (V <sub>INL</sub> = 0.2 V, V <sub>INH</sub> = 1.7 V)
	SR <sub>f</sub>	—	(1)	—		
Gain bandwidth product	GBW	—	(1.5)	—	MHz	V <sub>IN</sub> = 1.5 V, C <sub>L</sub> = 15 pF

Note: ( ) : Design specification

## Table of Graphs

Electrical Characteristics			Characteristic Curves	Test Circuit No.
Supply current	$I_{DD}$	vs. Supply voltage	1	1
		vs. Temperature	2	1
Output high voltage	$V_{OH}$	vs. Rload	3	2
Output low voltage	$V_{OL}$	vs. Rload	4	3
Output source current	$I_{OSOURCE}$	vs. Output high voltage	5	4
		vs. Temperature	6	4
Output sink current	$I_{OSINK}$	vs. Output low voltage	7	5
		vs. Temperature	8	5
Input offset voltage	$V_{IO}$	vs. Supply voltage	9	6
		vs. Input voltage	10	6
		vs. Temperature	11	7
Common mode input voltage range	$V_{CM}$	vs. Supply voltage	12	8
		vs. Temperature	13	8
Common mode rejection ratio	CMRR	vs. Input voltage	14	9
Power supply rejection ratio	PSRR	vs. Supply voltage	15	10
Input bias current	$I_{IB}$	vs. Input voltage	16	11, 12
		vs. Temperature	17	11, 12
Slew rate (rising)	SRr	vs. Cload	18	13
		vs. Temperature	19	13
		Time waveform	20	13
Slew rate (falling)	SRf	vs. Cload	21	13
		vs. Temperature	22	13
		Time waveform	23	13
Open loop gain	$A_V$	vs. Rload	24	14
		vs. Frequency	25, 26	14
Phase margin	PM	vs. Cload	27	14
Noise input voltage	VNI	vs. Frequency	28	15

**Test Circuits**

(Unless otherwise noted,  $V_{DD} = 3\text{ V}$ ,  $V_{SS} = 0\text{ V}$ ,  $T_a = 25^\circ\text{C}$ )

1. Supply Current,  $I_{DD}$

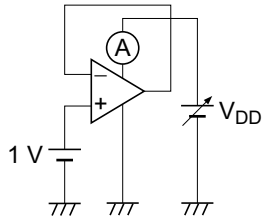

2. Output High Voltage,  $V_{OH}$

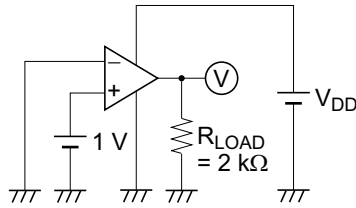

3. Output Low Voltage,  $V_{OL}$

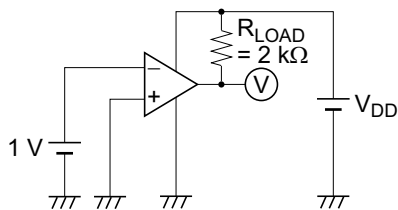

4. Output Source Current,  $I_{OSOURCE}$

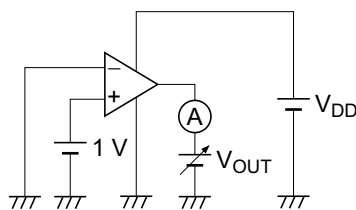

5. Output Sink Current,  $I_{OSINK}$

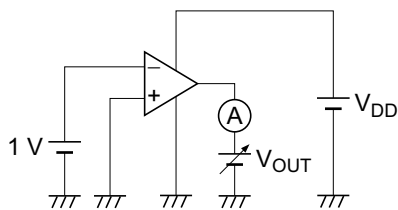

6. Input Offset Voltage vs. Operating Voltage

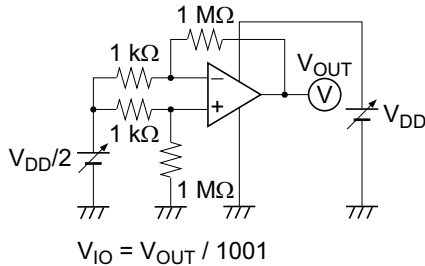

7. Input Offset Voltage,  $V_{IO}$

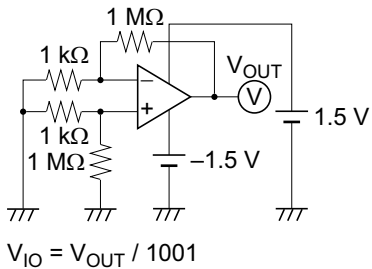

8. Common Mode Input Voltage Range,  $V_{CM}$

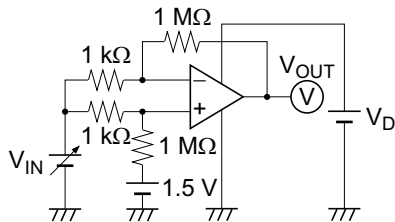

Note:  
 $V_{CML}$  and  $V_{CMH}$  are values of  $V_{IN}$  when  $V_{IO}$  changes more than 50 dB taking  $V_{IN} = 0\text{ V}$  as reference.

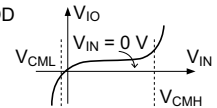

**Test Circuits (cont.)**

(Unless otherwise noted,  $V_{DD} = 3\text{ V}$ ,  $V_{SS} = 0\text{ V}$ ,  $T_a = 25^\circ\text{C}$ )

**9. Common Mode Rejection Ratio, CMRR**

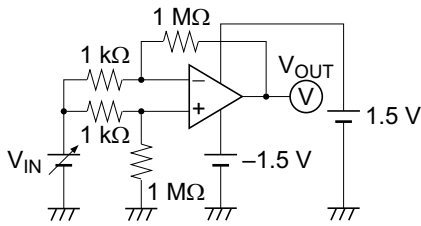

$V_{IN}$	Measure Point	Calculate $V_{IO}$	CMRR Calculation
-1.5 V	$V_{OUT1}$	$V_{IO1} = V_{OUT1} / 1001$	$\text{CMRR} = \left  20 \log_{10} \frac{ V_{IO2} - V_{IO1} }{0.3 - (-1.5\text{ V})} \right $
0.3 V	$V_{OUT2}$	$V_{IO2} = V_{OUT2} / 1001$	

**10. Power Supply Rejection Ratio, PSRR**

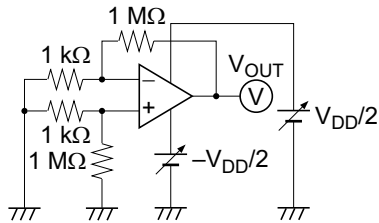

$V_{DD}$	Measure Point	Calculate $V_{IO}$	CMRR Calculation
2.7 V	$V_{OUT1}$	$V_{IO1} = V_{OUT1} / 1001$	$\text{PSRR} = \left  20 \log_{10} \frac{ V_{IO2} - V_{IO1} }{5.5\text{ V} - 2.7\text{ V}} \right $
5.5 V	$V_{OUT2}$	$V_{IO2} = V_{OUT2} / 1001$	

**11. Input Bias Current,  $I_{B+}$**

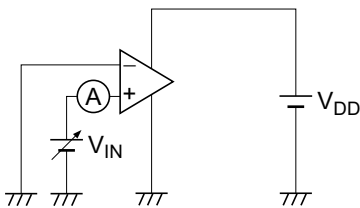

**12. Input Bias Current,  $I_{B-}$**

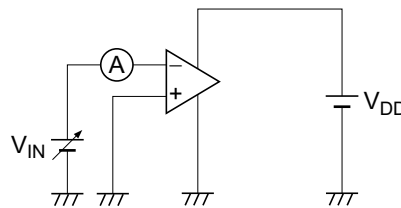

**13. Slew Rate (Large Signal Input)**

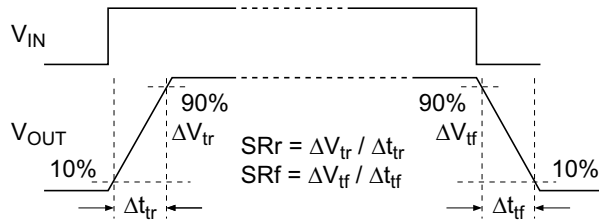
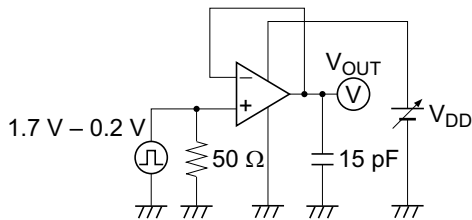

## Test Circuits (cont.)

(Unless otherwise noted,  $V_{DD} = 3\text{ V}$ ,  $V_{SS} = 0\text{ V}$ ,  $T_a = 25^\circ\text{C}$ )

### 14. Open Loop Voltage Gain, $A_V$

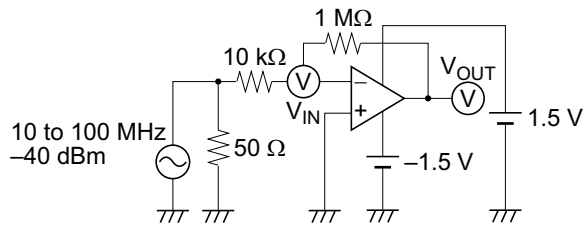

$$A_V = \left| 20 \log_{10} \frac{101 \times |V_{OUT}|}{|V_{IN}|} \right|$$

### 15. Noise Input Voltage, VNI

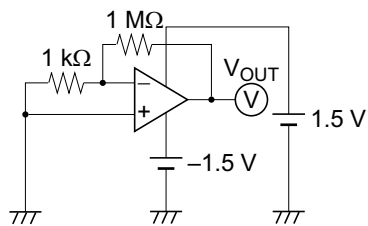

$$VNI = \frac{V_{OUT}}{1001}$$

Characteristic Curves

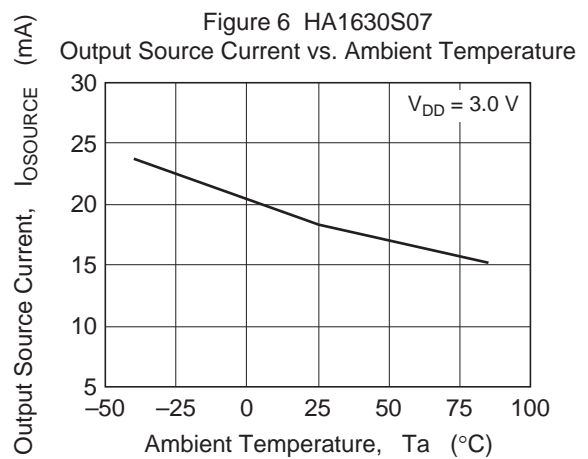
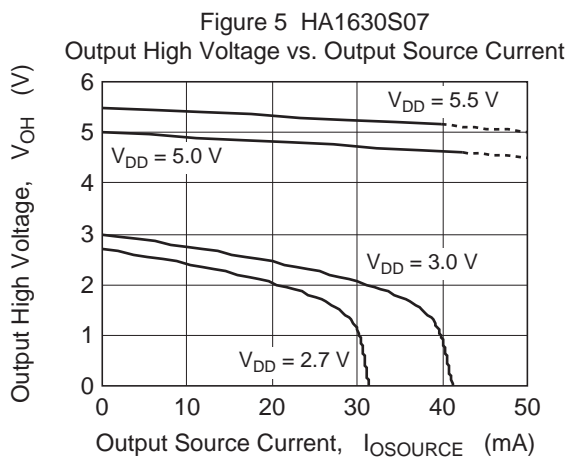
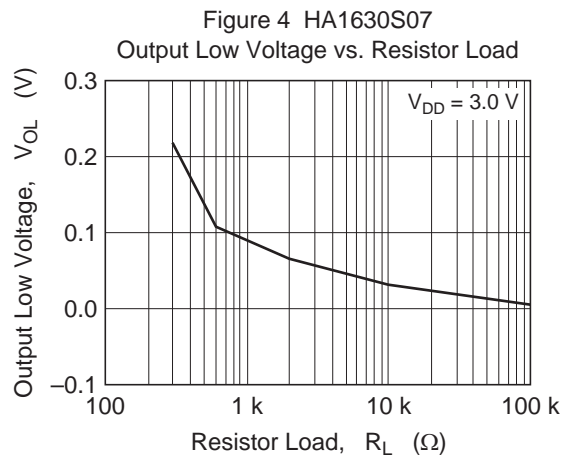
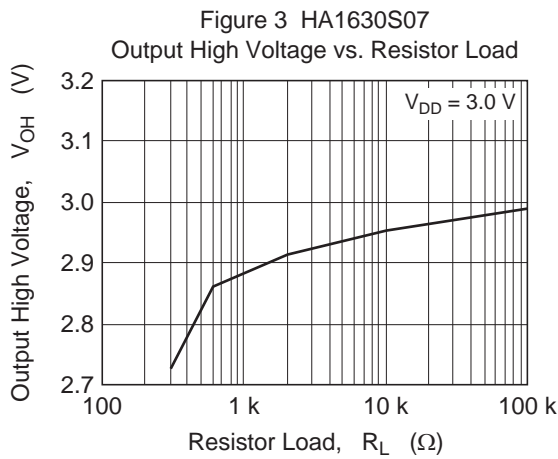
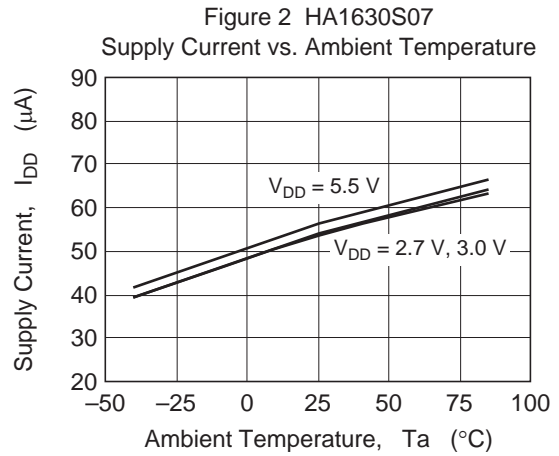
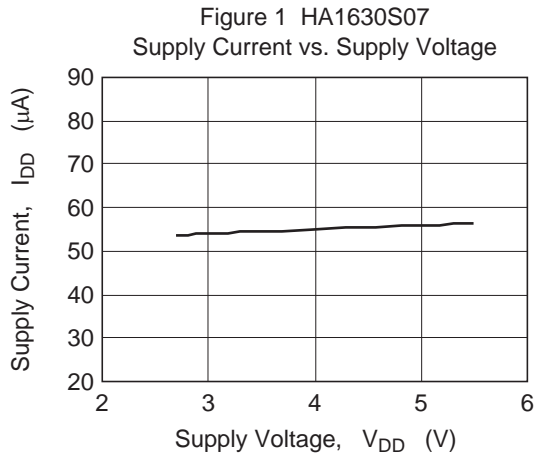



Characteristic Curves (cont.)

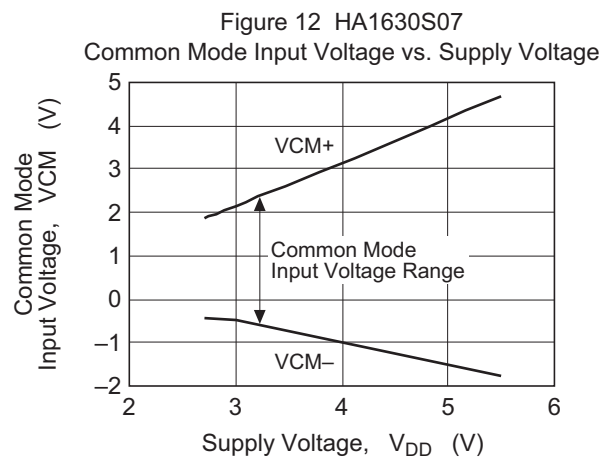
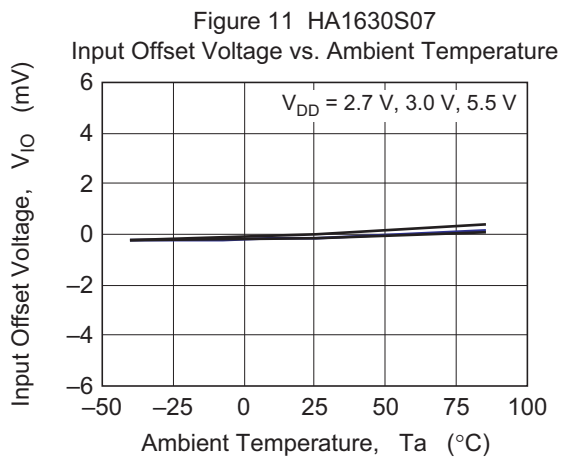
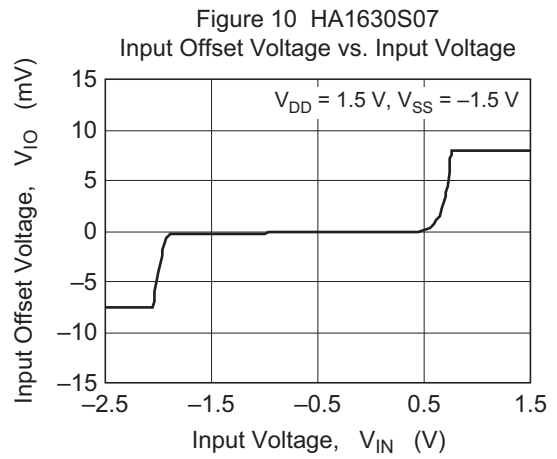
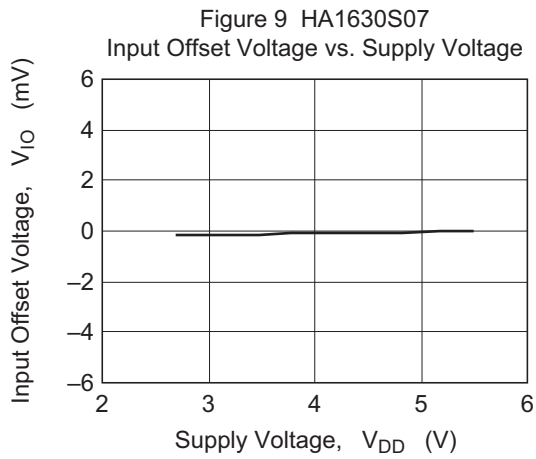
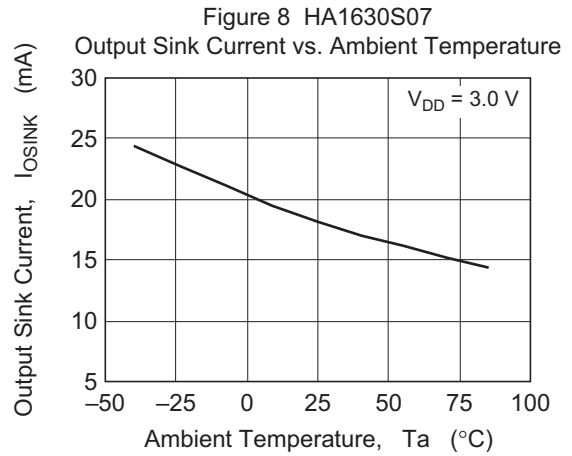
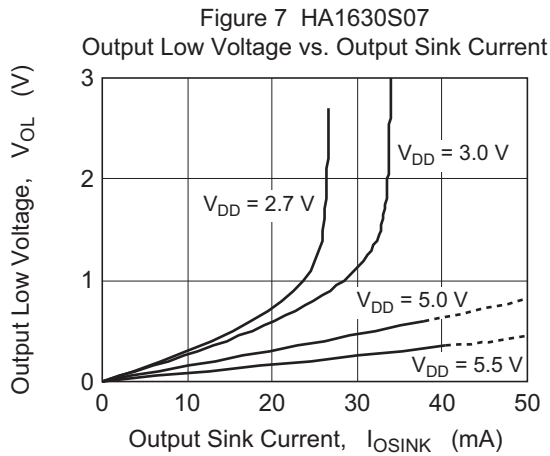

Characteristic Curves (cont.)

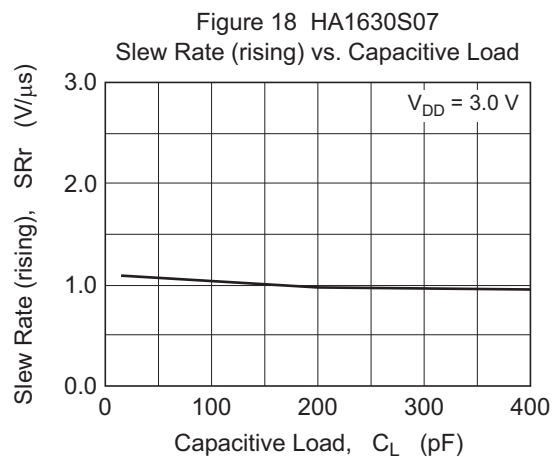
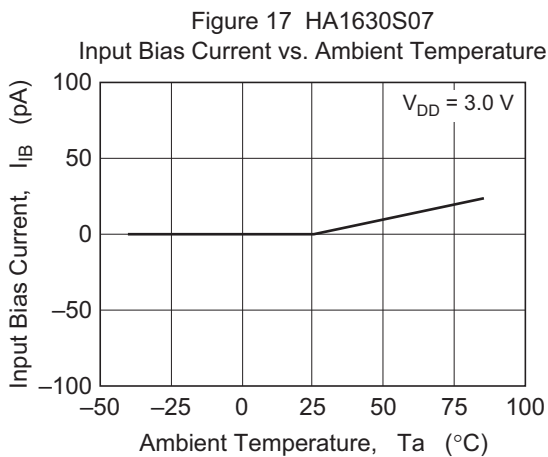
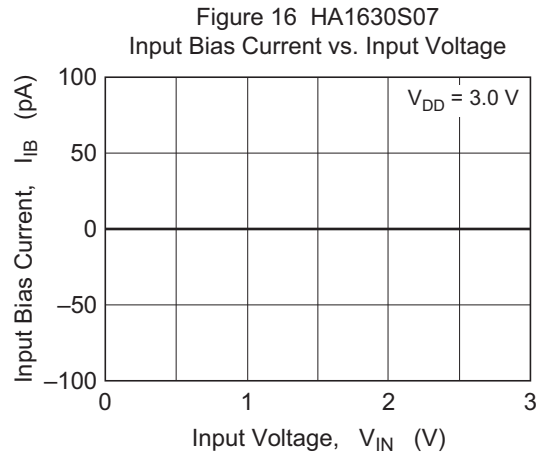
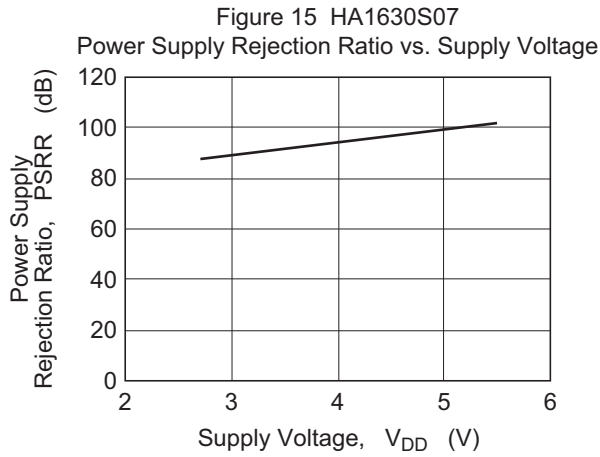
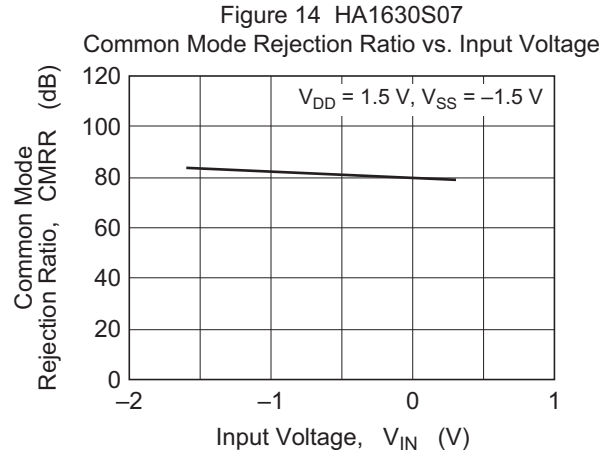
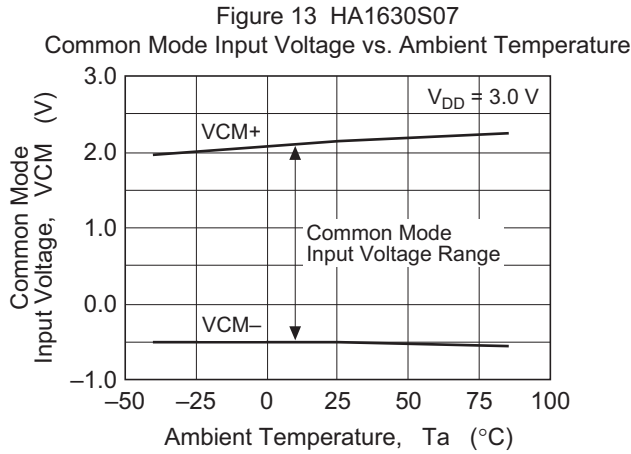

Characteristic Curves (cont.)

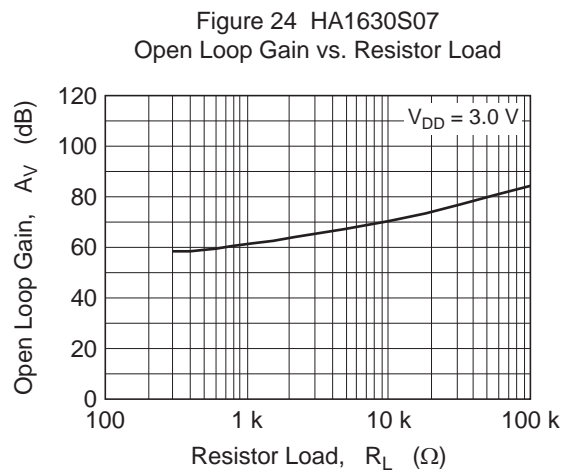
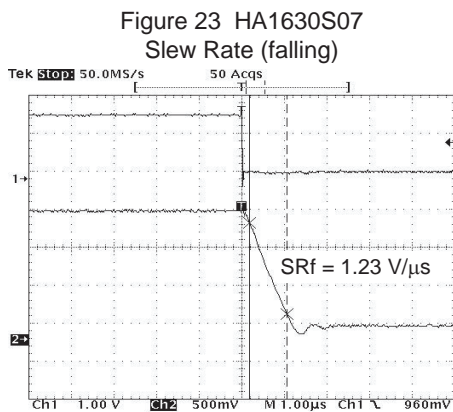
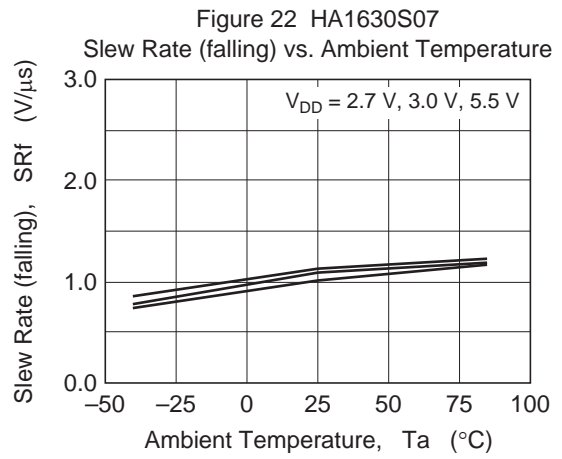
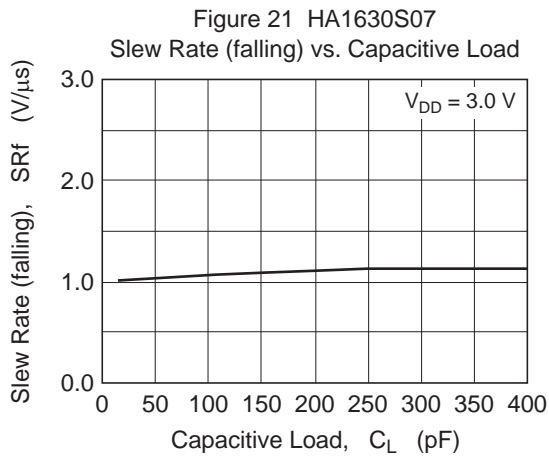
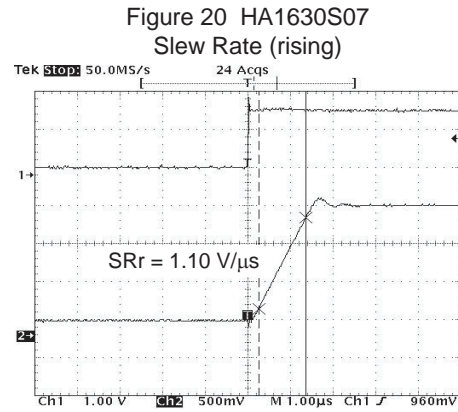
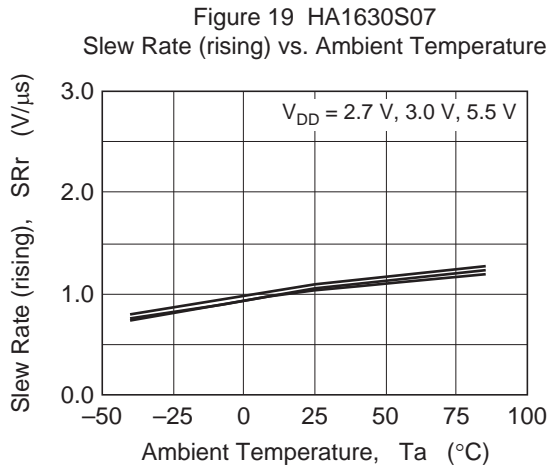

Characteristic Curves (cont.)

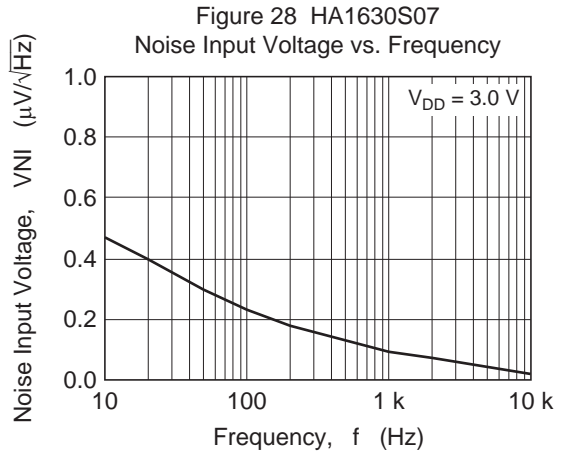
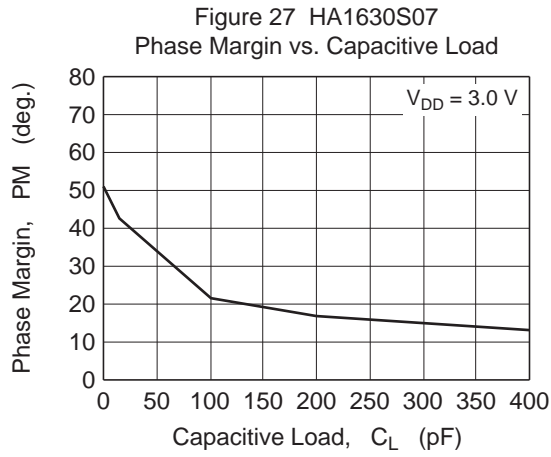
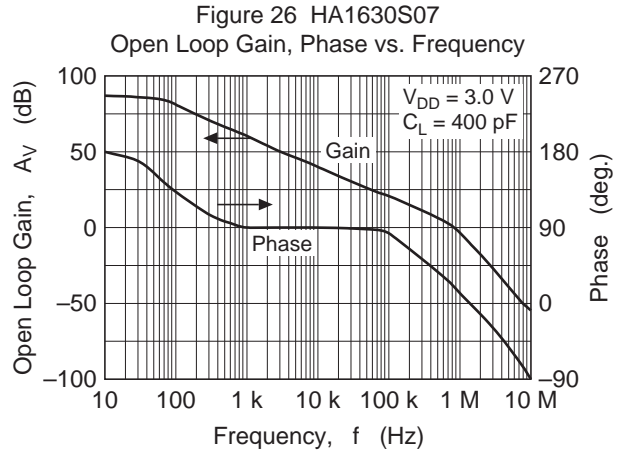
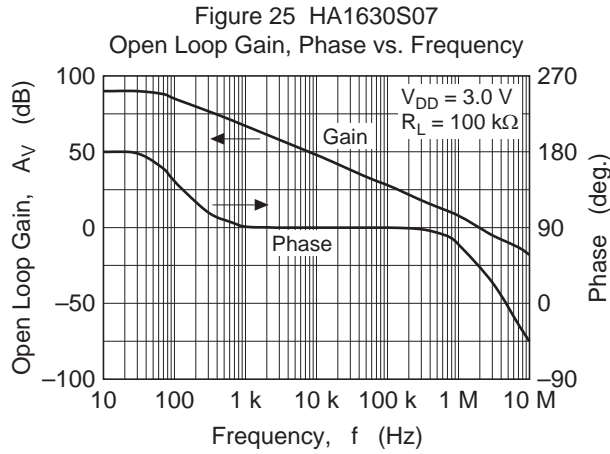

### Package Dimensions

JEITA Package Code	RENESAS Code	Previous Code	MASS (Typ) [g]
SC-88A	PTSP0005ZC-A	CMPAK-5 / CMPAK-5V	0.006

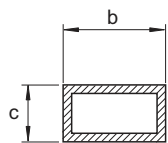
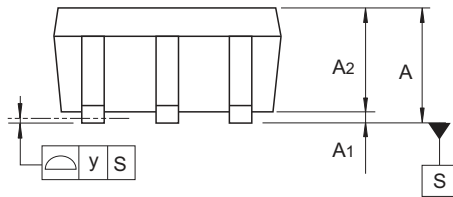
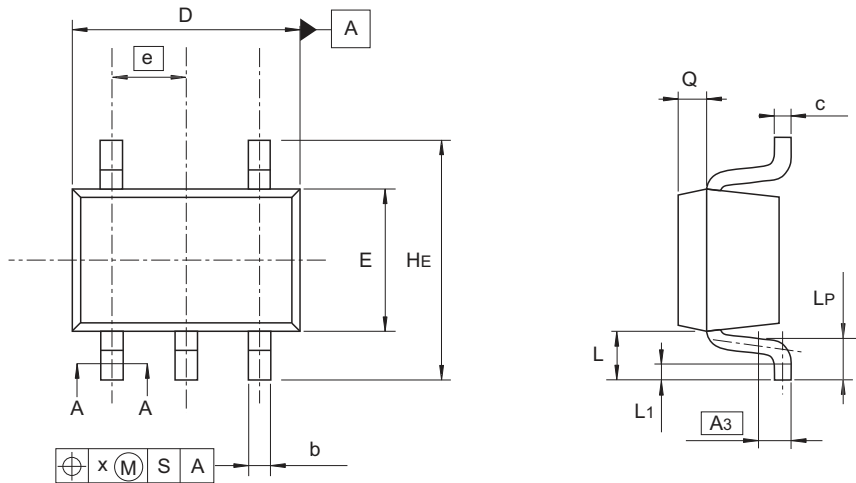

A-A Section

Reference Symbol	Dimensions in millimeters		
	Min	Nom	Max
A	0.8	—	1.1
A <sub>1</sub>	0	—	0.1
A <sub>2</sub>	0.8	0.9	1.0
A <sub>3</sub>	—	0.25	—
b	0.15	0.22	0.3
c	0.1	0.13	0.15
D	1.8	2.0	2.2
E	1.15	1.25	1.35
e	—	0.65	—
HE	1.8	2.1	2.4
L	0.3	—	0.7
L <sub>1</sub>	0.1	—	0.5
LP	0.2	—	0.6
x	—	—	0.05
y	—	—	0.05
Q	—	0.25	—

© 2013 Renesas Electronics Corporation. All rights reserved.

JEITA Package Code	RENESAS Code	Previous Code	MASS (Typ) [g]
SC-74A	PLSP0005ZB-A	MPAK-5 / MPAK-5V	0.015

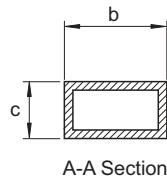
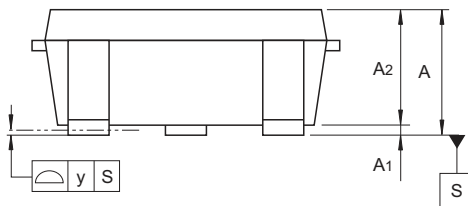
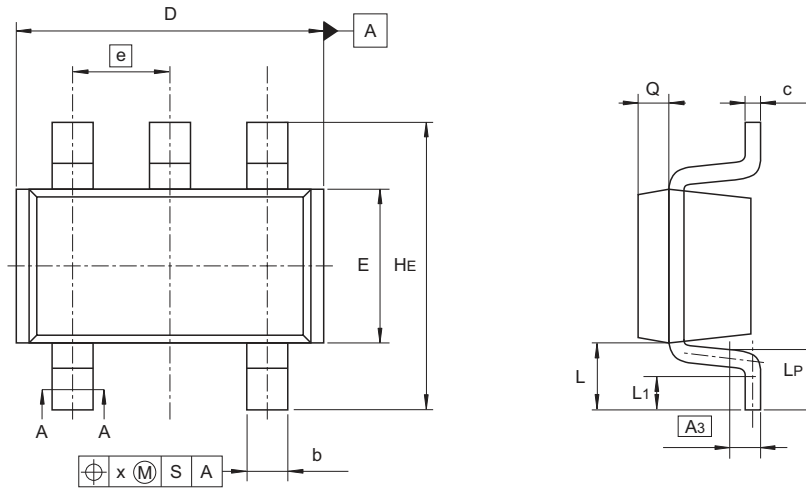

Reference Symbol	Dimensions in millimeters		
	Min	Nom	Max
A	1.0	—	1.4
A <sub>1</sub>	0	—	0.1
A <sub>2</sub>	1.0	1.1	1.3
A <sub>3</sub>	—	0.25	—
b	0.35	0.4	0.5
c	0.11	0.16	0.26
D	2.8	2.95	3.1
E	1.5	1.6	1.8
e	—	0.95	—
H <sub>E</sub>	2.5	2.8	3.0
L	0.3	—	0.7
L <sub>1</sub>	0.1	—	0.5
LP	0.2	—	0.6
x	—	—	0.05
y	—	—	0.05
Q	—	0.3	—

© 2013 Renesas Electronics Corporation. All rights reserved.

### Taping & Reel Specification

[Taping]

Package Code	W	P	Ao	Bo	Ko	E	F	D1	Maximum Storage No.
MPAK-5	8	4	3.3	3.3	1.5	1.75	3.5	1.05	3,000 pcs/reel
CMPAK-5	8	4	2.25	2.45	1.1	1.75	3.5	1.05	3,000 pcs/reel

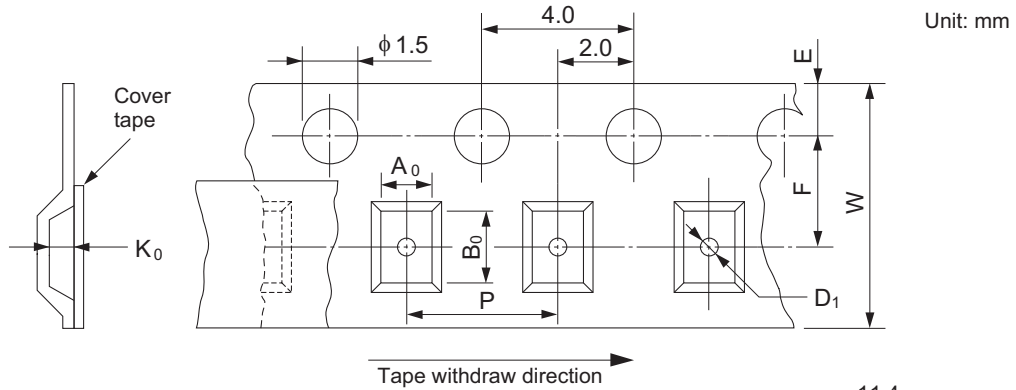

[Reel]

Package	Tape width	W1	W2
MPAK-5	8	11.4	9
CMPAK-5	8	11.4	9

[Ordering Information]

Ordering Unit
3,000 pcs

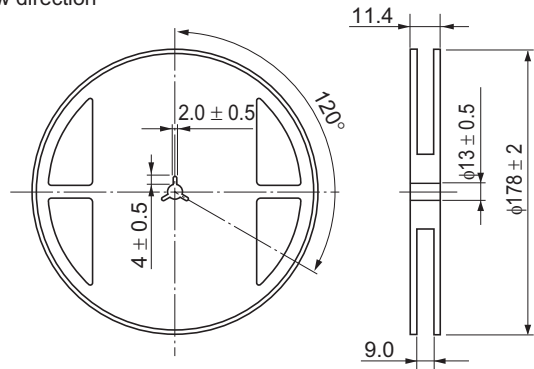

### Mark Indication

• MPAK-5

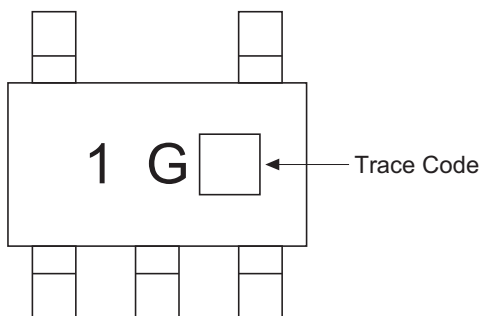

• CMPAK-5

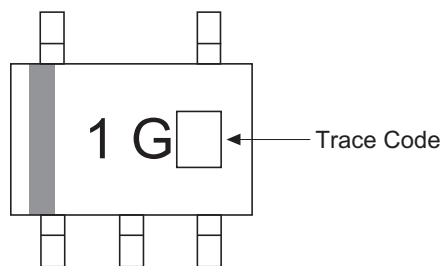

## Notice

1. Descriptions of circuits, software and other related information in this document are provided only to illustrate the operation of semiconductor products and application examples. You are fully responsible for the incorporation of these circuits, software, and information in the design of your equipment. Renesas Electronics assumes no responsibility for any losses incurred by you or third parties arising from the use of these circuits, software, or information.
2. Renesas Electronics has used reasonable care in preparing the information included in this document, but Renesas Electronics does not warrant that such information is error free. Renesas Electronics assumes no liability whatsoever for any damages incurred by you resulting from errors in or omissions from the information included herein.
3. Renesas Electronics does not assume any liability for infringement of patents, copyrights, or other intellectual property rights of third parties by or arising from the use of Renesas Electronics products or technical information described in this document. No license, express, implied or otherwise, is granted hereby under any patents, copyrights or other intellectual property rights of Renesas Electronics or others.
4. You should not alter, modify, copy, or otherwise misappropriate any Renesas Electronics product, whether in whole or in part. Renesas Electronics assumes no responsibility for any losses incurred by you or third parties arising from such alteration, modification, copy or otherwise misappropriation of Renesas Electronics product.
5. Renesas Electronics products are classified according to the following two quality grades: "Standard" and "High Quality". The recommended applications for each Renesas Electronics product depends on the product's quality grade, as indicated below.  
"Standard": Computers; office equipment; communications equipment; test and measurement equipment; audio and visual equipment; home electronic appliances; machine tools; personal electronic equipment; and industrial robots etc.  
"High Quality": Transportation equipment (automobiles, trains, ships, etc.); traffic control systems; anti-disaster systems; anti-crime systems; and safety equipment etc.  
Renesas Electronics products are neither intended nor authorized for use in products or systems that may pose a direct threat to human life or bodily injury (artificial life support devices or systems, surgical implantations etc.), or may cause serious property damages (nuclear reactor control systems, military equipment etc.). You must check the quality grade of each Renesas Electronics product before using it in a particular application. You may not use any Renesas Electronics product for any application for which it is not intended. Renesas Electronics shall not be in any way liable for any damages or losses incurred by you or third parties arising from the use of any Renesas Electronics product for which the product is not intended by Renesas Electronics.
6. You should use the Renesas Electronics products described in this document within the range specified by Renesas Electronics, especially with respect to the maximum rating, operating supply voltage range, movement power voltage range, heat radiation characteristics, installation and other product characteristics. Renesas Electronics shall have no liability for malfunctions or damages arising out of the use of Renesas Electronics products beyond such specified ranges.
7. Although Renesas Electronics endeavors to improve the quality and reliability of its products, semiconductor products have specific characteristics such as the occurrence of failure at a certain rate and malfunctions under certain use conditions. Further, Renesas Electronics products are not subject to radiation resistance design. Please be sure to implement safety measures to guard them against the possibility of physical injury, and injury or damage caused by fire in the event of the failure of a Renesas Electronics product, such as safety design for hardware and software including but not limited to redundancy, fire control and malfunction prevention, appropriate treatment for aging degradation or any other appropriate measures. Because the evaluation of microcomputer software alone is very difficult, please evaluate the safety of the final products or systems manufactured by you.
8. Please contact a Renesas Electronics sales office for details as to environmental matters such as the environmental compatibility of each Renesas Electronics product. Please use Renesas Electronics products in compliance with all applicable laws and regulations that regulate the inclusion or use of controlled substances, including without limitation, the EU RoHS Directive. Renesas Electronics assumes no liability for damages or losses occurring as a result of your noncompliance with applicable laws and regulations.
9. Renesas Electronics products and technology may not be used for or incorporated into any products or systems whose manufacture, use, or sale is prohibited under any applicable domestic or foreign laws or regulations. You should not use Renesas Electronics products or technology described in this document for any purpose relating to military applications or use by the military, including but not limited to the development of weapons of mass destruction. When exporting the Renesas Electronics products or technology described in this document, you should comply with the applicable export control laws and regulations and follow the procedures required by such laws and regulations.
10. It is the responsibility of the buyer or distributor of Renesas Electronics products, who distributes, disposes of, or otherwise places the product with a third party, to notify such third party in advance of the contents and conditions set forth in this document, Renesas Electronics assumes no responsibility for any losses incurred by you or third parties as a result of unauthorized use of Renesas Electronics products.
11. This document may not be reproduced or duplicated in any form, in whole or in part, without prior written consent of Renesas Electronics.
12. Please contact a Renesas Electronics sales office if you have any questions regarding the information contained in this document or Renesas Electronics products, or if you have any other inquiries.  
(Note 1) "Renesas Electronics" as used in this document means Renesas Electronics Corporation and also includes its majority-owned subsidiaries.  
(Note 2) "Renesas Electronics product(s)" means any product developed or manufactured by or for Renesas Electronics.



### SALES OFFICES

Renesas Electronics Corporation

<http://www.renesas.com>

Refer to "<http://www.renesas.com/>" for the latest and detailed information.

**Renesas Electronics America Inc.**  
2880 Scott Boulevard Santa Clara, CA 95050-2554, U.S.A.  
Tel: +1-408-586-6000, Fax: +1-408-588-6130

**Renesas Electronics Canada Limited**  
1101 Nicholson Road, Newmarket, Ontario L3Y 9C3, Canada  
Tel: +1-905-898-5441, Fax: +1-905-898-3220

**Renesas Electronics Europe Limited**  
Dukes Meadow, Millboard Road, Bourne End, Buckinghamshire, SL8 5FH, U.K.  
Tel: +44-1628-651-700, Fax: +44-1628-651-804

**Renesas Electronics Europe GmbH**  
Arcadiastrasse 10, 40472 Düsseldorf, Germany  
Tel: +49-211-65030, Fax: +49-211-6503-1327

**Renesas Electronics (China) Co., Ltd.**  
7th Floor, Quantum Plaza, No.27 ZhiChunLu Haidian District, Beijing 100083, P.R.China  
Tel: +86-10-8235-1155, Fax: +86-10-8235-7679

**Renesas Electronics (Shanghai) Co., Ltd.**  
Unit 301, Tower A, Central Towers, 555 LanGao Rd., Putuo District, Shanghai, China  
Tel: +86-21-2226-0888, Fax: +86-21-2226-0999

**Renesas Electronics Hong Kong Limited**  
Unit 1601-1613, 16/F., Tower 2, Grand Century Place, 193 Prince Edward Road West, Mongkok, Kowloon, Hong Kong  
Tel: +852-2886-9318, Fax: +852 2886-9022/9044

**Renesas Electronics Taiwan Co., Ltd.**  
13F, No. 363, Fu Shing North Road, Taipei, Taiwan  
Tel: +886-2-8175-9600, Fax: +886 2-8175-9670

**Renesas Electronics Singapore Pte. Ltd.**  
80 Bendemeer Road, Unit #06-02 Hyflux Innovation Centre Singapore 339949  
Tel: +65-6213-0200, Fax: +65-6213-0300

**Renesas Electronics Malaysia Sdn.Bhd.**  
Unit 906, Block B, Menara Amcorp, Amcorp Trade Centre, No. 18, Jln Persiaran Barat, 46050 Petaling Jaya, Selangor Darul Ehsan, Malaysia  
Tel: +60-3-7955-9390, Fax: +60-3-7955-9510

**Renesas Electronics Korea Co., Ltd.**  
12F., 234 Teheran-ro, Gangnam-Gu, Seoul, 135-080, Korea  
Tel: +82-2-558-3737, Fax: +82-2-558-5141