

DESCRIPTION: FEMALE - DIP SOLDER / MACHINED - ECONOMY

No. OF PINS	DIMENSIONS							
	A	B	C	D	E	F	G	H
9	1.213	0.984	0.642	0.311	0.236	0.756	0.496	0.427
	30.80	24.99	16.30	7.90	5.99	19.20	12.60	10.85
15	1.541	1.312	0.970	0.311	0.236	1.091	0.496	0.427
	39.15	33.32	24.65	7.90	5.99	27.70	12.60	10.85
25	2.083	1.874	1.512	0.311	0.236	1.630	0.496	0.427
	52.91	47.80	38.41	7.90	5.99	41.40	12.60	10.85

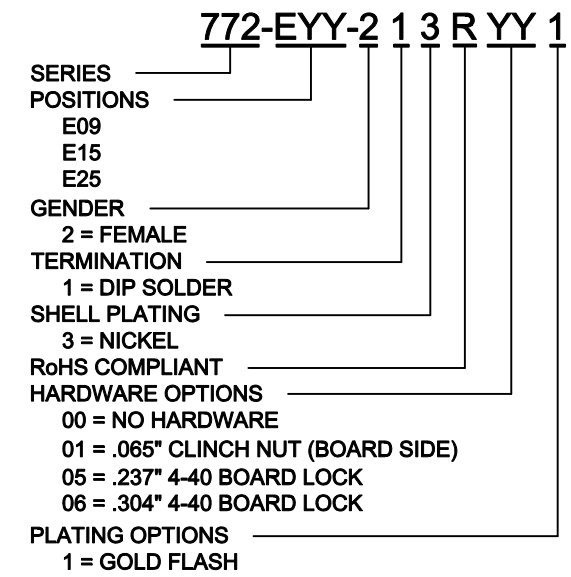
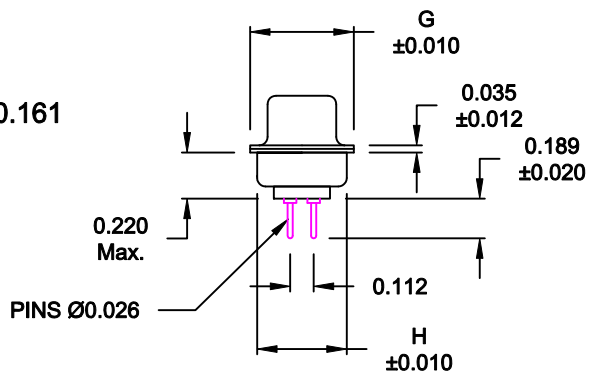
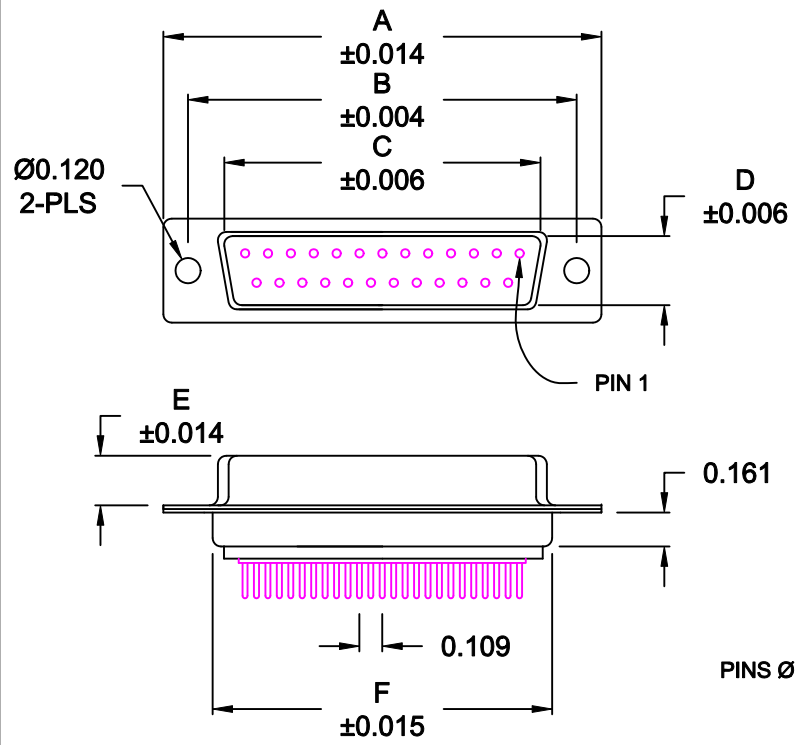

MATERIAL:

- SHELL: STEEL, NICKEL PLATED
- INSULATOR: UL 94V-O RATED, WHITE, PA6T
- PROCESS TEMP.: 260° PROCESS TEMPERATURE
- CONTACT: BRASS
- SEALING MATERIAL: F04 FLEXIBLE ADHESIVE

ELECTRICAL:

- CURRENT RATING: 5 AMPS
- CONTACT RESISTANCE: 15 mOhms Max.
- INSULATION RESISTANCE: 1,000 MOhms min.
- VOLTAGE: 500VAC FOR 1 MINUTE
- TEMPERATURE: -50° C TO 100° C

MEETS IP67 STANDARDS
(SEE PAGE 3 FOR SEALING DETAILS)

DO NOT SCALE FROM DRAWING

RoHS COMPLIANT

	THESE DRAWINGS AND SPECIFICATIONS ARE THE PROPERTY OF NorComp AND SHALL NOT BE REPRODUCED, COPIED OR USED AS THE BASIS FOR THE MANUFACTURE OR SALE OF APPARATUS WITHOUT WRITTEN PERMISSION.		DRAWN: PAM JENKINS	DATE: 9-4-08
	SCALE: 1:1			SHEET 1 OF 3
		DWG NO. 772-EYY-213RYY1		

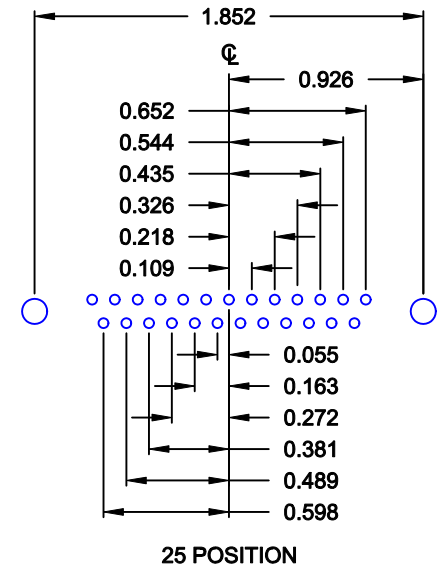
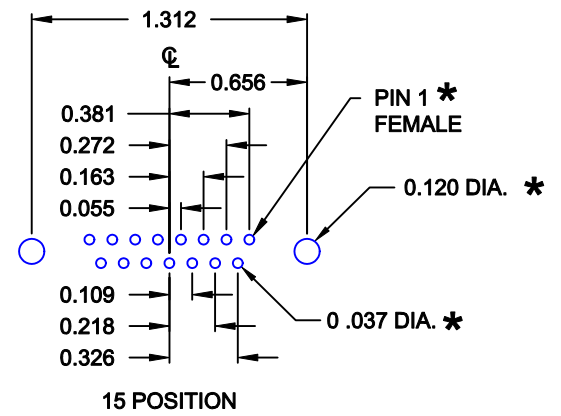
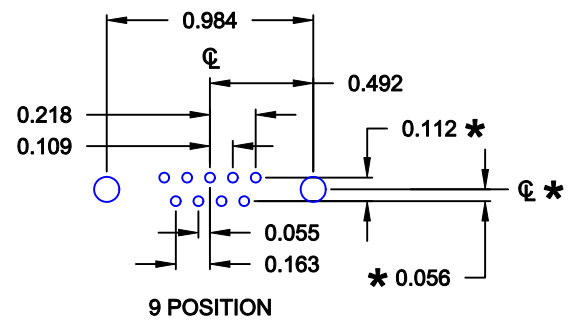

* TYP. ON ALL SIZES

DO NOT SCALE FROM DRAWING

	THESE DRAWINGS AND SPECIFICATIONS ARE THE PROPERTY OF NorComp AND SHALL NOT BE REPRODUCED, COPIED OR USED AS THE BASIS FOR THE MANUFACTURE OR SALE OF APPARATUS WITHOUT WRITTEN PERMISSION.		DRAWN: C. SMITH	DATE: 9-4-08
			CHECKED:	DATE:
<h1>NorComp</h1>		SCALE: FULL	SHEET 2 OF 3	REV 4
		DWG NO. 772-EYY-213RYY1		

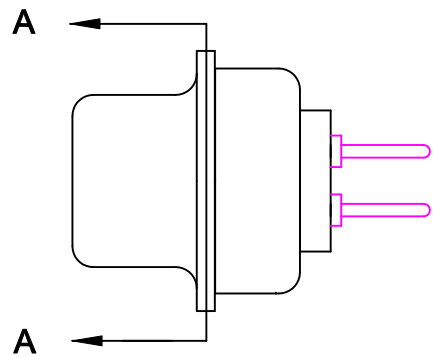

FRONT SEAL APPLIED BETWEEN FRONT INSULATOR AND FRONT METAL SHELL

MIDDLE SEAL APPLIED BETWEEN FRONT INSULATOR AND BACK INSULATOR

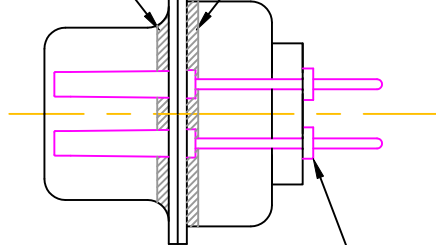

DETAIL A-A

****NOTE****
SEALING MATERIAL SHALL NOT PROTRUDE PAST THE CONTACT SHOULDER

HARDWARE OPTIONS

01X 0.065" (BOARD SIDE) - CN1

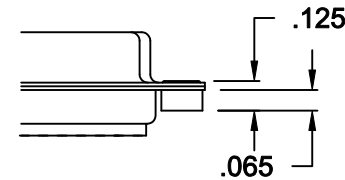

05X 0.237" (BOARD SIDE) - CN10

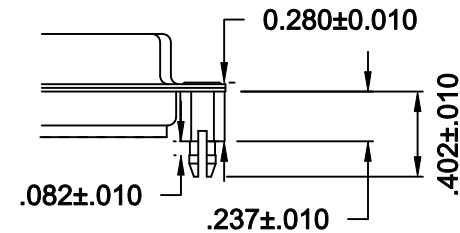

06X 0.304" (BOARD SIDE) - CN6

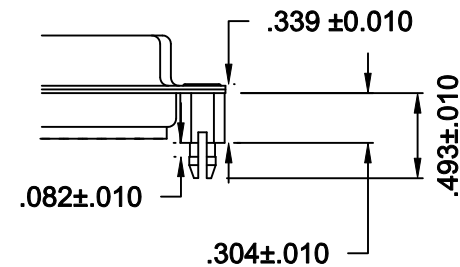

DO NOT SCALE FROM DRAWING



THESE DRAWINGS AND SPECIFICATIONS ARE THE PROPERTY OF NorComp AND SHALL NOT BE REPRODUCED, COPIED OR USED AS THE BASIS FOR THE MANUFACTURE OR SALE OF APPARATUS WITHOUT WRITTEN PERMISSION.

DRAWN:
C. SMITH

DATE:
03-26-09

CHECKED:

DATE:

NorComp

SCALE: **2.5 : 1** SHEET **3** OF **3** REV **4**

DWG NO. **772-EYY-213RYY1**