

# MAXIM

## MAX8671 Evaluation Kit

**Evaluates: MAX8671X**

### General Description

The MAX8671 evaluation kit (EV kit) is a fully assembled and tested printed-circuit board (PCB) for evaluating the MAX8671X power-management IC. The MAX8671X integrated power-management IC (PMIC) is ideal for use in portable media players and other handheld devices. In addition to five regulated output voltages, the MAX8671X integrates a 1-cell lithium ion (Li+) or lithium polymer (Li-Poly) charger and Smart Power Selector™ (SPS) with dual (AC-to-DC adapter and USB) power inputs.

### Features

- ◆ 16V-Tolerant USB and DC Inputs
- ◆ Automatically Powers from External Power or Battery
- ◆ Operates with No Battery Present
- ◆ Single-Cell Li+/Li-Poly Charger
- ◆ Three 2MHz Step-Down Regulators Up to 96% Efficiency
- ◆ Two Low Iq Linear Regulators
- ◆ Output Power-Up Sequencing
- ◆ Thermal-Overload Protection
- ◆ Fully Assembled and Tested

### Ordering Information

PART	TYPE
MAX8671EVKIT+	EV Kit

+Denotes lead-free and RoHS-compliant.

### Component List

DESIGNATION	QTY	DESCRIPTION
C1, C2	2	4.7µF ±10%, 16V X5R ceramic capacitors (0805) TDK C2012X5R1C475K Murata GRM21BR61C475KA Taiyo Yuden EMK212BJ475MG
C3, C11	2	0.1µF ±10%, 10V X5R ceramic capacitors (0402) TDK C1005X5R1A104K Murata GRM155R61A104K
C4, C7	2	1µF ±20%, 6.3V X5R ceramic capacitors (0603) TDK C1608X5R0J105M Murata GRM188R60J105K
C5, C6	2	2.2µF ±10%, 6.3V X5R ceramic capacitors (0603) TDK C1608X5R0J225K
C8, C13–C16, C18, C19	7	10µF ±20%, 6.3V X5R ceramic capacitors (0805) TDK C2012X5R0J106M Murata GRM21BR60J106K
C9, C12, C17, C20	4	4.7µF ±20%, 6.3V X5R ceramic capacitors (0603) TDK C1608X5R0J475M Murata GRM188R60J475K

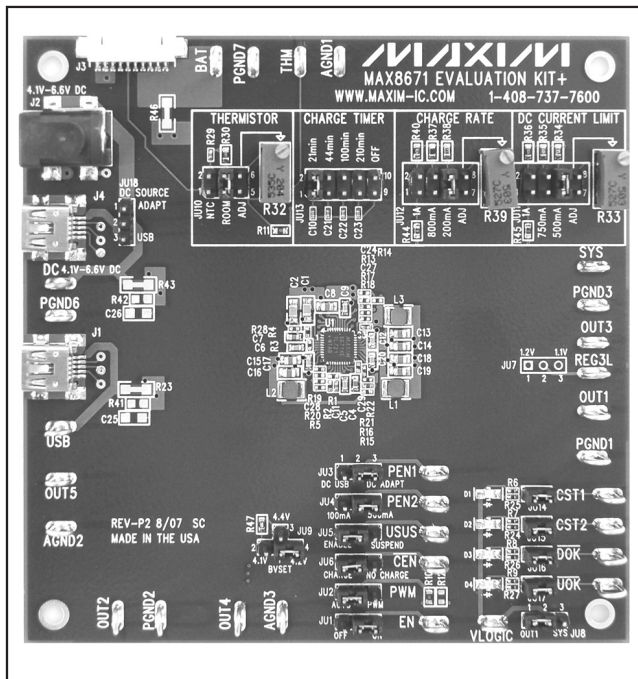

Figure 1. MAX8671 EV Kit Photo

Smart Power Selector is a trademark of Maxim Integrated Products, Inc.



For pricing, delivery, and ordering information, please contact Maxim Direct at 1-888-629-4642, or visit Maxim's website at [www.maxim-ic.com](http://www.maxim-ic.com).

# MAX8671 Evaluation Kit

## Component List (continued)

DESIGNATION	QTY	DESCRIPTION
C10	1	4700pF ±10%, 50V X7R ceramic capacitor (0402) TDK C1005X7R1H472K
C21	1	0.01µF ±10%, 25V X7R ceramic capacitor (0402) TDK C1005X7R1E103K
C22	1	0.022µF ±10%, 25V X7R ceramic capacitor (0402) TDK C1005X7R1E223K
C23	1	0.047µF ±10%, 10V X5R ceramic capacitor (0402) TDK C1005X5R1A473K
C24, C27, C28, C29	0	Not installed, capacitors (0402)
C25, C26	0	Not installed, capacitors (1206)
D1–D4	4	Green surface-mount LEDs (0805) Lumex SML-LXT0805GW-TR
J1, J4	2	USB mini-AB receptacles Cypress 131-0050-5110 Molex 67803-8021 or USB mini-B receptacle without position posts Hirose Electric UX60A-MB-5ST
J2	1	Male 2.1mm power connector CUI PJ-002A-SMT
J3	1	10-circuit, 1.25mm (0.049in) pitch surface-mount right-angle header, lead-free Molex 53261-1071
JU1, JU3–JU6, JU8, JU18	7	3-pin headers (0.1in)
JU2, JU7	0	Not installed, 3-pin headers
JU9	1	4-pin header, three-way (0.1in)
JU10	1	3 x 2-pin header (0.1in)
JU11, JU12	2	4 x 2-pin headers (0.1in)
JU13	1	5 x 2-pin header (0.1in)
JU14–JU17	4	2-pin headers (0.1in)
L1, L2, L3	3	4.7µH, 770mA, 130mΩ inductors (3mm x 3mm x 1.2mm) Taiyo Yuden NR3012T4R7M

DESIGNATION	QTY	DESCRIPTION
R1	1	200kΩ ±1% resistor (0402)
R2	1	61.9kΩ ±1% resistor (0402)
R3	1	332kΩ ±1% resistor (0402)
R4	1	75kΩ ±1% resistor (0402)
R5, R13, R14, R15	0	Not installed, resistors (0402)
R6–R9	4	560kΩ ±5% resistors (0402)
R10	1	100kΩ ±5% resistor (0603)
R11, R30	2	10kΩ ±1% resistors (0603)
R12	0	Not installed, resistor (0603)
R16, R28	2	0Ω resistors (0402)
R17	1	20kΩ ±1% resistor (0402)
R18, R19, R21	3	100kΩ ±1% resistors (0402)
R20	1	80.6kΩ ±1% resistor (0402)
R22	1	232kΩ ±1% resistor (0402)
R23, R43, R46	0	Not installed, resistors—PCB short (1206)
R24–R27	4	221Ω ±1% resistors (0402)
R29	1	10kΩ NTC thermistor (0402) Murata NCP15XH103F03 (β = 3380K)
R32	1	200kΩ, 25-turn potentiometer Bourns 3296Y-1-204 LF
R33, R39	2	50kΩ, 25-turn potentiometers Bourns 3296Y-1-503 LF
R34	1	6.04kΩ ±1% resistor (0603)
R35	1	4.02kΩ ±1% resistor (0603)
R36, R40	2	3.01kΩ ±1% resistors (0603)
R37	1	3.74kΩ ±1% resistor (0603)
R38	1	15kΩ ±1% resistor (0603)
R41, R42	0	Not installed, resistors (0805)
R44, R45	2	0Ω resistors (0603)
R47	1	49.9kΩ ±1% resistor (0603)
U1	1	MAX8671XETL+ (40-pin thin QFN, 5mm x 5mm x 0.8mm)
—	1	PCB: MAX8671 Evaluation Kit+
—	16	Shunts 2 position

# MAX8671 Evaluation Kit

## Component Suppliers

SUPPLIER	PHONE	WEBSITE
Bourns, Inc.	951-781-5690	www.bourns.com
CUI Inc.	503-612-2300	www.cui.com
Molex	630-969-4550	www.molex.com
Murata Mfg. Co., Ltd.	814-237-1431	www.murata.com
Taiyo Yuden	408-573-4150	www.t-yuden.com
TDK Corp.	847-803-6100	www.component.tdk.com
TOKO	847-297-0070	www.toko.com
Vishay	402-563-6866	www.vishay.com

**Note:** Indicate that you are using the MAX8671 when contacting these component suppliers.

## Quick Start

### Recommended Equipment

Before beginning, the following equipment is needed:

- Single-cell Li+ or Li-Poly battery
- Voltmeter
- Loads
- 5V AC-to-DC adapter
- USB cable (standard-A plug to mini-B plug)
- USB host port (i.e., hub, computer, etc.)

### Procedure

The MAX8671 EV Kit is fully assembled and tested. Follow the steps below to verify board operation:

- 1) Verify that all jumpers are set in the default position, as indicated in Table 2.
- 2) Connect loads from the desired step-down outputs (OUT1, OUT2, and OUT3) to the nearest PGND\_ pad. The maximum load current for each output is shown in Table 1.
- 3) If desired, connect loads from the LDO outputs (OUT4 and OUT5) to the nearest AGND\_ pad. The maximum load current for each output is shown in Table 1.
- 4) Connect an Li+ or Li-Poly battery from the BAT terminal to PGND7, or plug battery into connector J3.
- 5) Optionally, connect an AC-to-DC adapter to J2.
- 6) Connect a USB cable (standard-A plug to mini-B plug) from a USB host port (i.e., hub, computer, etc.) to J1 on the EV kit.
- 7) Using a voltmeter, verify that the output voltages match the values shown in Table 1.

## Detailed Description

### Regulator Outputs

The MAX8671X has five power outputs: three step-down DC-DC regulators (OUT1, OUT2, and OUT3) and two low-dropout (LDO) linear regulators (OUT4 and OUT5). All output voltages are adjustable and set by external resistors on the EV kit board. See the *Setting the Output Voltages* section for information on calculating these resistor values. The default voltages and maximum current for each output is listed in Table 1.

To enable the regulator outputs, connect pins 2-3 of JU1. To turn off all regulators, connect pins 1-2 of JU1.

By default, the EV kit sets the step-down regulators (OUT1, OUT2, and OUT3) to operate in auto-PWM mode. This has the best light-load efficiency and is recommended for most applications. The MAX8671X also has a forced-PWM mode that forces the regulators to switch with a constant 2MHz frequency. This is useful for low-noise applications. To evaluate the forced-PWM mode, remove resistor R10 and install a 100k $\Omega$  resistor in R12. This must be a permanent connection—**Do not change PWM on the fly.**

All regulators are powered from the system supply (SYS) by default. An option is provided for powering OUT4 from the OUT2 supply. This is useful when the OUT4 voltage is lower than OUT2. To use the OUT2 supply to power OUT4, remove the 0 $\Omega$  resistor from R16 and install a 0 $\Omega$  resistor at R15.

**Table 1. Default Output Voltages and Maximum Load Currents**

OUTPUT	TYPE	DEFAULT VOLTAGE (V)	MAX CURRENT (mA)
OUT1	Step-Down	3.3	425
OUT2	Step-Down	1.8	425
OUT3	Step-Down	1.2	425
OUT4	LDO	2.5	180
OUT5	LDO	3.3	180

### Setting the Output Voltages

The step-down output voltages are adjustable from 1V to V<sub>sys</sub>, and the LDO outputs are adjustable from 0.6V to V<sub>sys</sub>. The voltage is adjusted by changing two resistors on the EV kit board. First, select the lower feedback resistor (R<sub>FBL</sub>), connected from FB\_ to AGND. R<sub>FBL</sub> is typically 100k $\Omega$  for the step-down regulators and 60.4k $\Omega$  for the LDOs. Next, find the value of R<sub>FBH</sub>

# MAX8671 Evaluation Kit

(connected between FB\_ and OUT\_) from the following equation:

$$R_{FBH} = R_{FBL} \times \left( \frac{V_{OUT}}{V_{FB}} - 1 \right)$$

where  $V_{FB}$  is 1V for OUT1, OUT2, and OUT3 and 0.6V for OUT4 and OUT5. When setting OUT4 or OUT5 below 1.5V, change the corresponding output capacitor (C5 for OUT4 and C6 for OUT5) to 3.3 $\mu$ F or greater.

### Smart Power Selector

The MAX8671X Smart Power Selector seamlessly distributes power between the two current-limited external inputs (USB and DC), the battery (BAT), and the system load (SYS). For detailed information on the MAX8671X operation, refer to the MAX8671X IC data sheet.

The USB input current is limited to 100mA or 500mA, selected with JU4 (PEN2). Connect pins 1-2 of JU4 for 100mA or connect pins 2-3 of JU4 for 500mA. To suspend the USB input, connect pins 2-3 of JU5 (USUS). Connect pins 1-2 of JU5 to enable the USB input.

The DC input operates in either USB or DC-adaptor mode, selected using JU3 (PEN1). Connect pins 1-2 of JU3 for USB mode or pins 2-3 for DC-adaptor mode. In USB mode, the DC current is limited the same as the USB input. In DC-adaptor mode, the DC current limit is set using JU11.

### Battery Charger

To enable the battery charger, connect pins 1-2 of JU6. To disable the battery charger, connect pins 2-3 of JU6. The battery regulation voltage is selected by JU9. The maximum fast-charge current is selected with JU12. The maximum charge time is selected using JU13 (see Table 3).

An NTC thermistor is used to provide overtemperature protection for the battery charger. The MAX8671 EV kit provides several options for evaluating this feature. To evaluate with an external thermistor (generally included in the battery pack), remove the shunt from JU10 and connect the thermistor from THM to PGND7 or from J3-6 to J3-10. To evaluate with the 10k $\Omega$  thermistor included on the EV kit board (R29), connect pins 1-2 of JU10. The on-board 10k $\Omega$  thermistor (R29) and the 10k $\Omega$  VL pullup resistor (R11) allow the battery to charge when the thermistor temperature is between 0°C to +52°C. To simulate a thermistor at room temperature, connect pins 3-4 of JU10. To use potentiometer R32 to simulate a thermistor at any temperature, connect pins 5-6 of

JU10 and adjust R32 as desired (turn clockwise to simulate higher temperatures). The MAX8671 EV kit is configured for use with a 10k $\Omega$  NTC thermistor. Recommended modifications for evaluating a 100k $\Omega$  thermistor are given in Table 4. The recommended 100k $\Omega$  thermistor from Table 4 and the 100k $\Omega$  VL pullup resistor (R11) allow the battery to charge when the thermistor temperature is between +5°C to +45°C. Refer to the *Battery Charger Thermistor Input (THM)* section of the MAX8671X IC data sheet for information on how to shift thermistor thresholds.

### Input Power Connections

USB power connects to USB mini-AB receptacle J1. Alternatively, connect USB power from the USB pad to the PGND6 pad.

Three options are available for connecting DC power, selected by jumper JU18. With JU18 pins 1-2 connected, DC is powered from an AC-to-DC adapter plugged directly into J2. The AC-to-DC adapter must output between 4.1V and 6.6V DC with the center contact positive, and provide the current set with JU11. One suitable AC-to-DC adapter is the CUI DPS050220UPS-P5P-S2. With JU18 pins 2-3 connected, DC is powered from USB mini-AB receptacle J4. Remove the shunt from JU18 to power DC from a supply connected from the DC pad to the PGND6 pad.

The Li+/Li-Poly battery connects from the BAT terminal to the PGND7 terminal on the EV kit. Alternatively, a battery connector (J3) is provided. J3 is a 10-circuit, 1.25mm (0.049in) pitch surface-mount header, Molex part number 53261-1071. The recommended mating connector is Molex 51021-1000 with crimp terminals 50058-8100. To crimp the terminals, use Molex crimper 63811-0200.

### Charge Status and Input Supply Monitor Outputs

Output indicators are provided on the MAX8671 EV kit for the two charge status indicators (CST1 and CST2) and the two input supply monitors (DOK and UOK). These pads connect to open-drain outputs with a pullup resistor to VLOGIC. Using JU8, VLOGIC can be connected to SYS or OUT1 on the EV kit board. Alternatively, an external VLOGIC supply can be connected to the VLOGIC pad with the shunt removed from JU8. LED indicators (D1–D4) are also provided on the EV kit. To enable the LED indicators, short pins 1-2 of JU14–JU17. A lit LED indicates that the corresponding output is logic-low.

# MAX8671 Evaluation Kit

Evaluates: MAX8671X

**Table 2. Jumper Functions**

JUMPER	NODE OR FUNCTION	POSITION	LOGIC LEVEL	FUNCTION
JU1	EN	1-2	Low	All regulators disabled
		2-3*	High	All regulators enabled
JU2 (not installed)	PWM	1-2 or Open*	Low	Auto PWM
		2-3	High	Forced PWM
JU3	PEN1	1-2*	Low	USB mode
		2-3	High	DC mode
JU4	PEN2	1-2*	Low	USB 100mA limit
		2-3	High	USB 500mA limit
JU5	USUS	1-2*	Low	USB enabled
		2-3	High	USB suspended
JU6	$\overline{\text{CEN}}$	1-2*	Low	Charger enabled
		2-3	High	Charger disabled
JU7 (not installed)	REG3L	—	—	Not used by the MAX8671X
JU8	VLOGIC	1-2	—	Logic pulled up to OUT1
		2-3*	—	Logic pulled up to SYS
		Open	—	External VLOGIC
JU9	BVSET	1-2	Low	4.1V battery
		1-3	Mid	4.4V battery
		1-4*	High	4.2V battery
		Open	High	4.2V battery
JU10	Thermistor Select	1-2	—	On-board thermistor R29
		3-4*	—	Simulate room temp R30
		5-6	—	Simulate any temperature with trim potentiometer R32
		Open	—	Simulate cold or connect an external thermistor to the THM pad or J3-6
JU11	DC Input Current Select	1-2*	—	1A
		3-4	—	750mA
		5-6	—	500mA
		7-8	—	Adjustable with trim potentiometer R33
		Open	—	No DC current
JU12	Charger Maximum Current Select	1-2	—	1A
		3-4*	—	800mA
		5-6	—	200mA
		7-8	—	Adjustable with trim potentiometer R39
		Open	—	No charge current
JU13	Charge Timer Select	—	—	See Table 3
JU14	CST1 Indicator LED	Open*	—	No indicator LED
		Short	—	Indicator LED
JU15	CST2 Indicator LED	Open*	—	No indicator LED
		Short	—	Indicator LED

\*Default position.

# MAX8671 Evaluation Kit

**Table 2. Jumper Functions (continued)**

JUMPER	NODE OR FUNCTION	POSITION	LOGIC LEVEL	FUNCTION
JU16	$\overline{DOK}$ Indicator LED	Open*	—	No indicator LED
		Short	—	Indicator LED
JU17	$\overline{UOK}$ Indicator LED	Open*	—	No indicator LED
		Short	—	Indicator LED
JU18	DC Input Connector	1-2*	—	Barrel connector J2
		2-3	—	USB connector J4
		Open	—	DC pad

\*Default position.

**Table 3. JU13 Charge Timer Select**

JU13: 9-10	JU13: 7-8	JU13: 5-6	JU13: 3-4	JU13: 1-2	C <sub>CT</sub> (nF)	t <sub>pQ</sub> (min)	t <sub>FC</sub> (min)
—	C23	C22	C21	C10			
—	0.047μF	0.022μF	0.01μF	4700pF			
0	0	0	0	0	0	0	0
0	0	0	0	1	4.70	10.5	21
0	0	0	1	0	10.0	2.20	44
0	0	0	1	1	14.7	3.25	65
0	0	1	0	0	22.0	5.00	100
0	0	1	0	1	26.7	6.05	121
0	0	1	1	0	32.0	7.20	144
0	0	1	1	1	36.7	8.25	165
0	1	0	0	0	47.0	10.5	210
0	1	0	0	1	51.7	11.6	231
0	1	0	1	0	57.0	12.7	254
0	1	0	1	1	61.7	13.8	275
0	1	1	0	0	69.0	15.5	310
0	1	1	0	1	73.7	16.6	331
0	1	1	1	0	79.0	17.7	354
0	1	1	1	1	83.7	18.8	375
1	0	0	0	0	—	∞	∞

"1" indicates that the capacitor is connected by shorting the corresponding pins of JU13.

**Table 4. Modifications to Support a 100kΩ Thermistor**

DESIGNATION	QTY	DESCRIPTION
R11	1	100kΩ ±1% resistor (0603)
R29	1	100kΩ ±1% NTC thermistor (0402) Murata NCP15WF104F03 (β = 4250K)
R30	1	100kΩ ±5% resistor (0603)
R32	1	500kΩ 25-turn potentiometer Bourns 3296Y-1-504 LF



# MAX8671 Evaluation Kit

Evaluates: MAX8671X

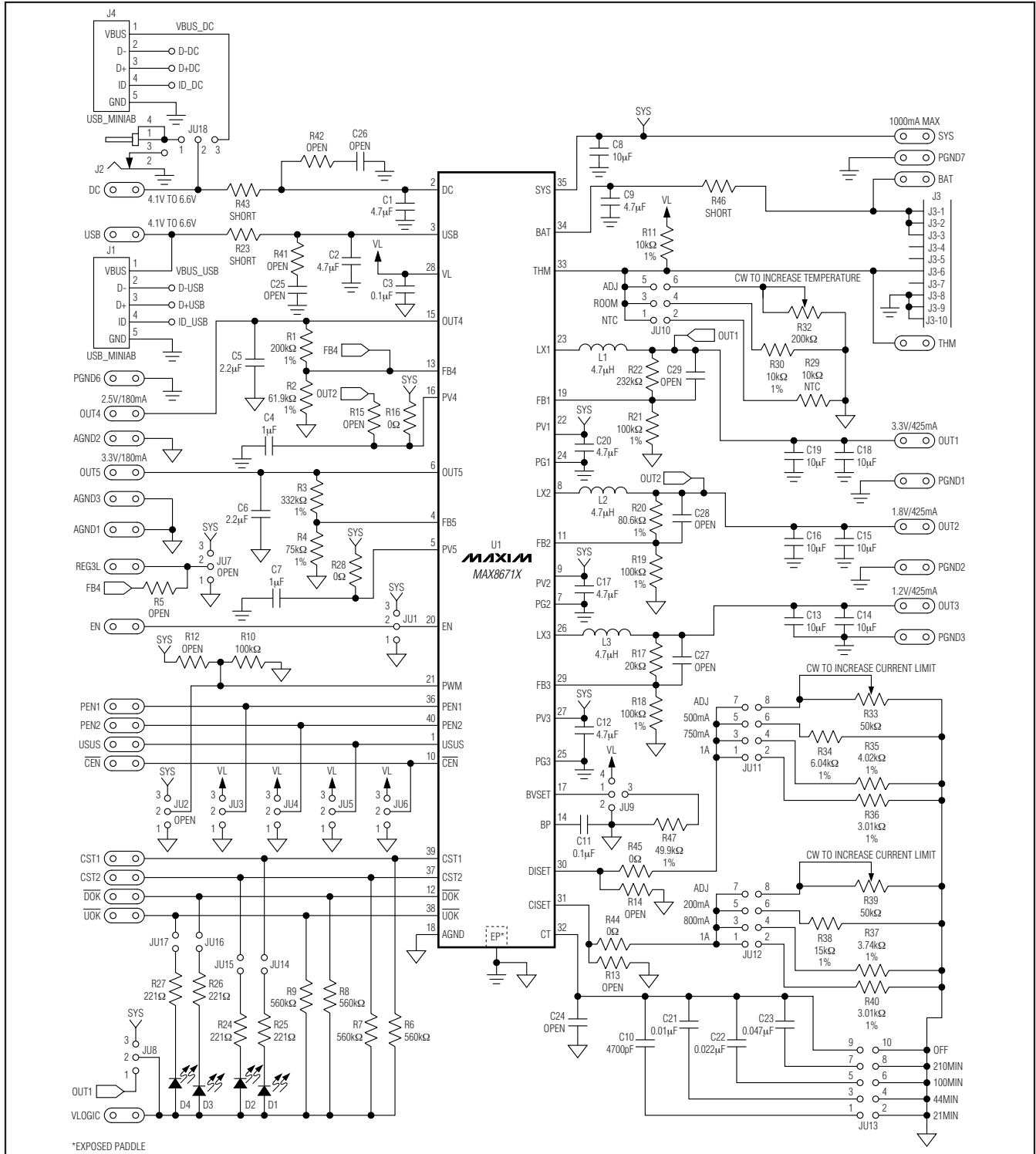

Figure 2. MAX8671 EV Kit Schematic

# MAX8671 Evaluation Kit

Evaluates: MAX8671X

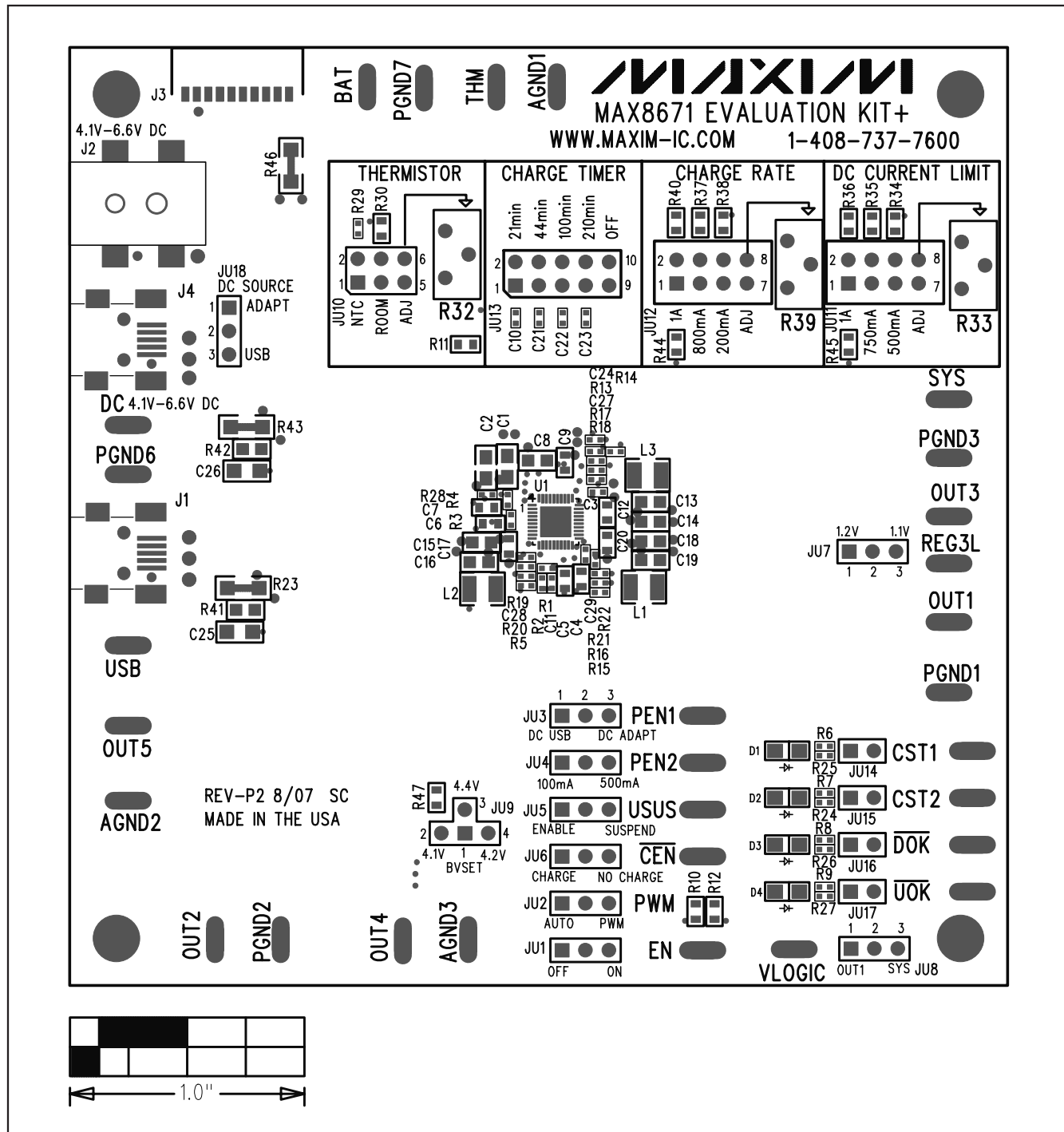

Figure 3. MAX8671 EV Kit Component Placement



# MAX8671 Evaluation Kit

Evaluates: MAX8671X

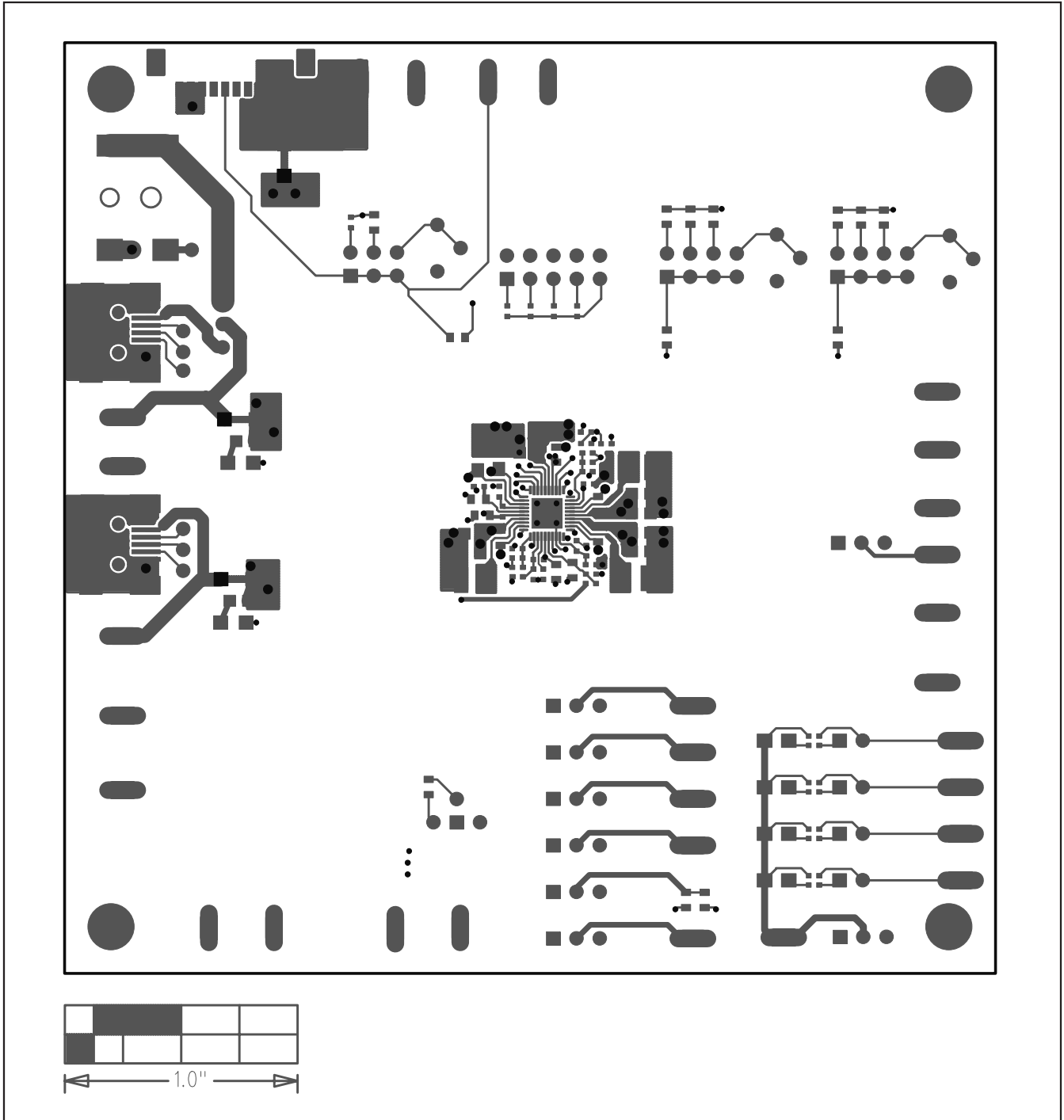

Figure 4. MAX8671 EV Kit PCB Layout—Component Layer 1

# MAX8671 Evaluation Kit

Evaluates: MAX8671X

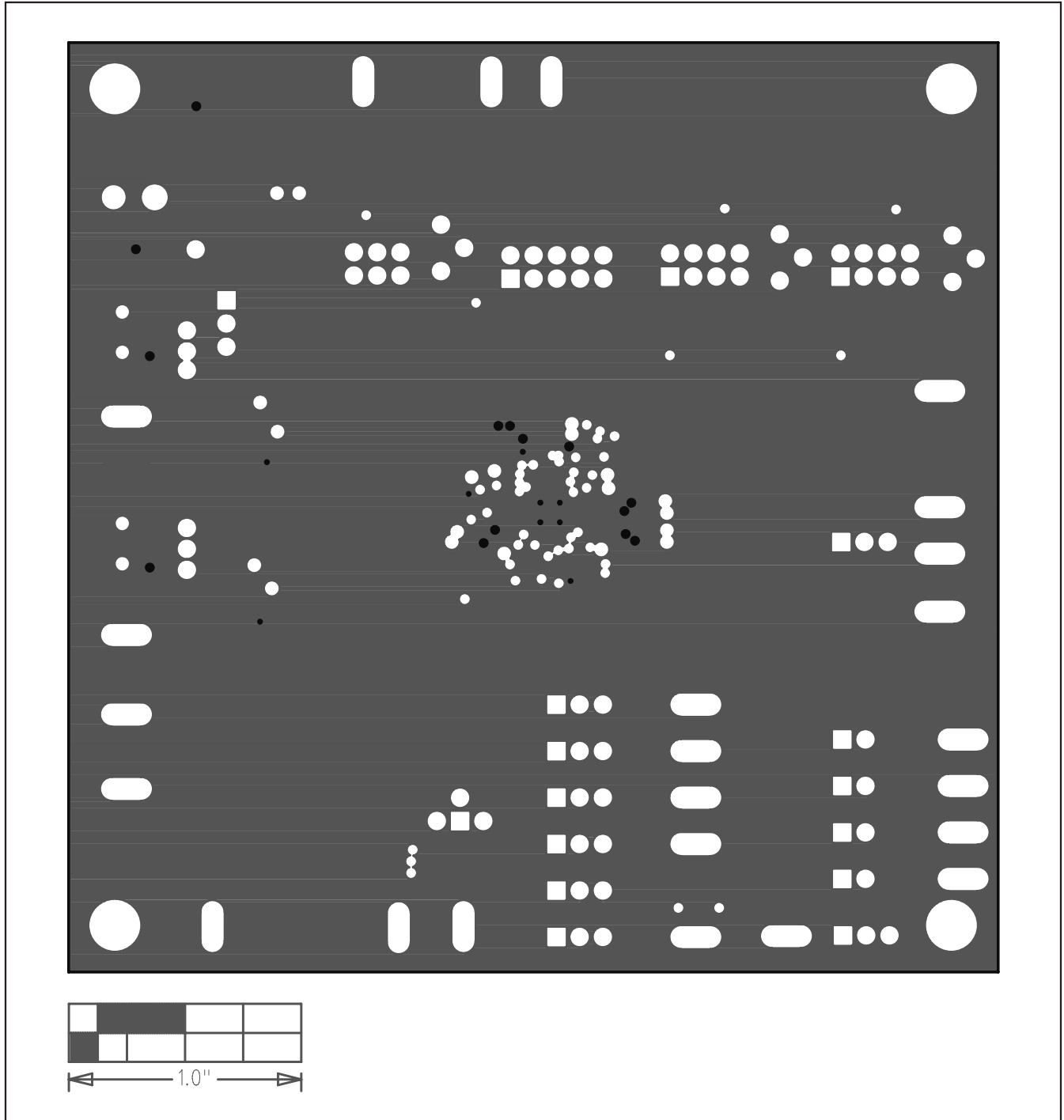

Figure 5. MAX8671 EV Kit PCB Layout—Ground Layer 2

# MAX8671 Evaluation Kit

Evaluates: MAX8671X

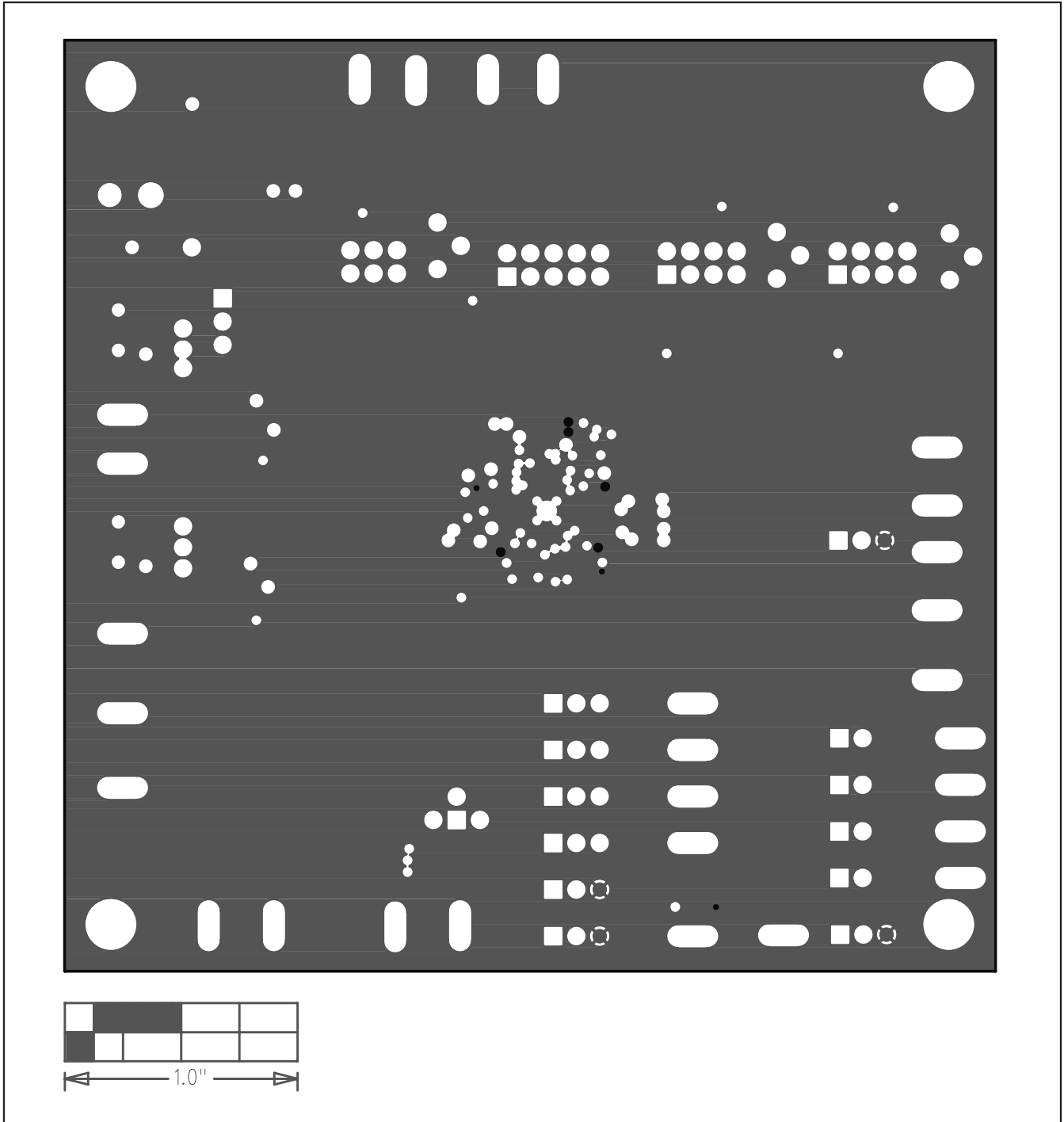

Figure 6. MAX8671 EV Kit PCB Layout—SYS Layer 3

# MAX8671 Evaluation Kit

Evaluates: MAX8671X

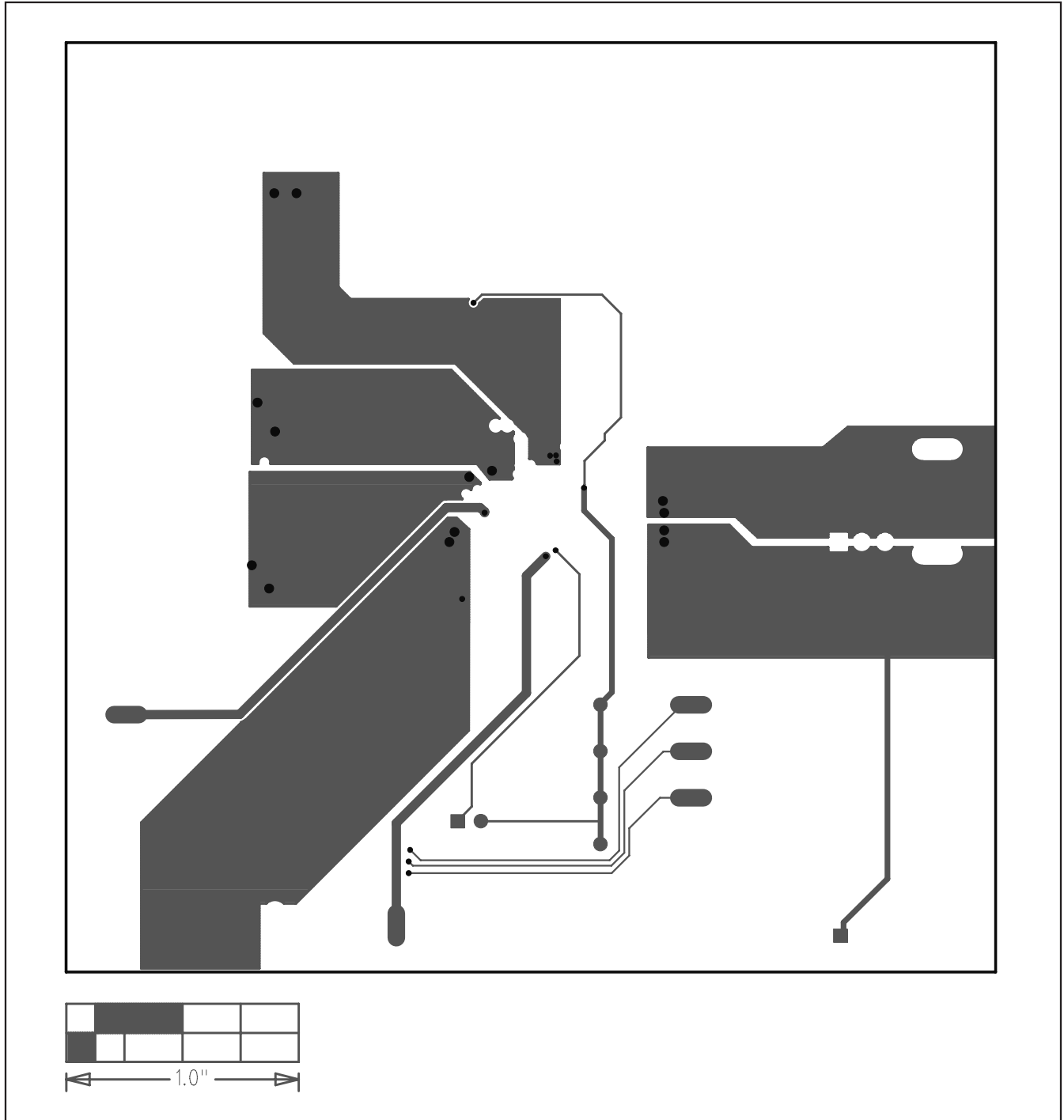

Figure 7. MAX8671 EV Kit PCB Layout—Power Layer 4

# MAX8671 Evaluation Kit

Evaluates: MAX8671X

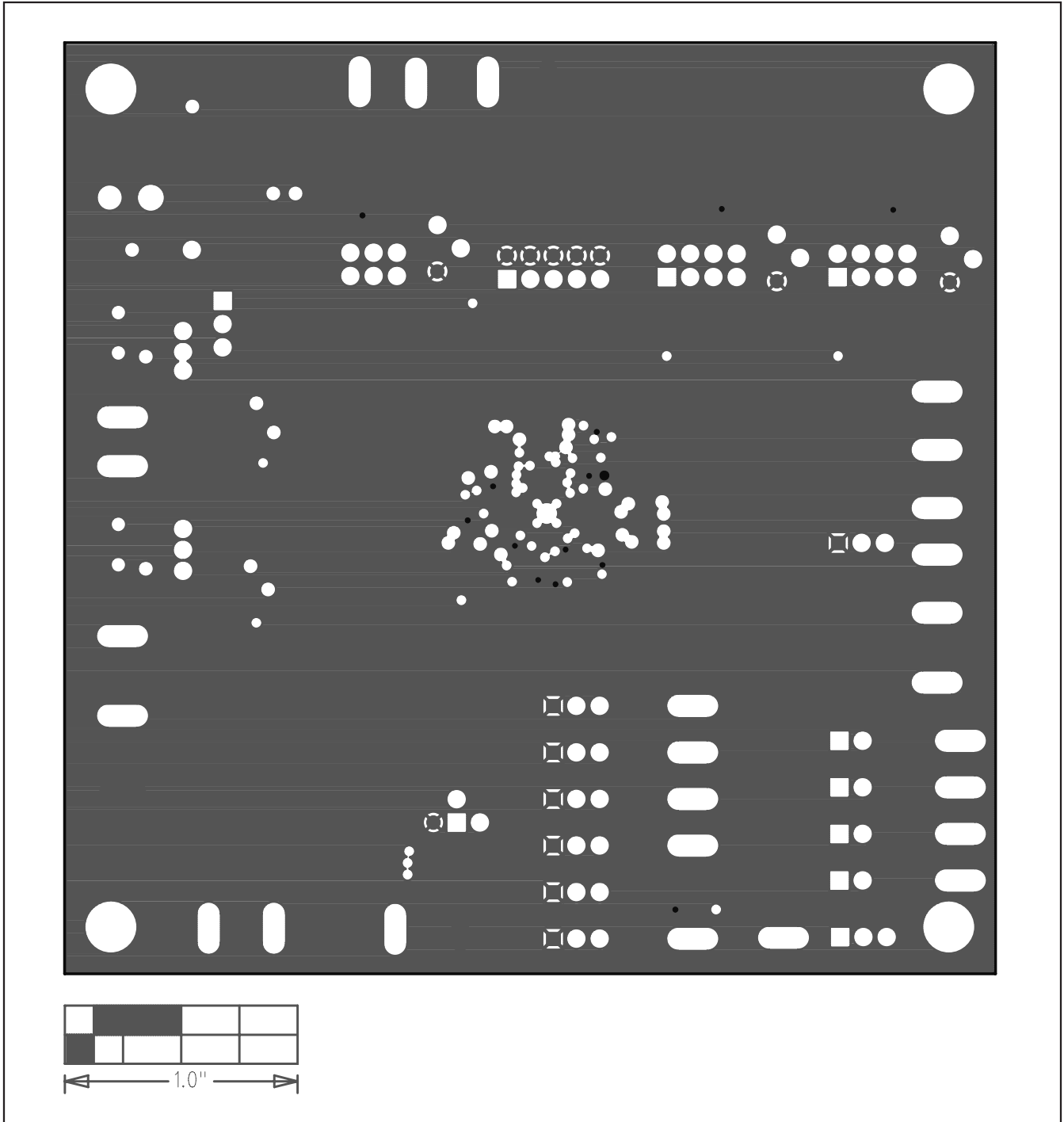

Figure 8. MAX8671 EV Kit PCB Layout—Analog Ground Layer 5

# MAX8671 Evaluation Kit

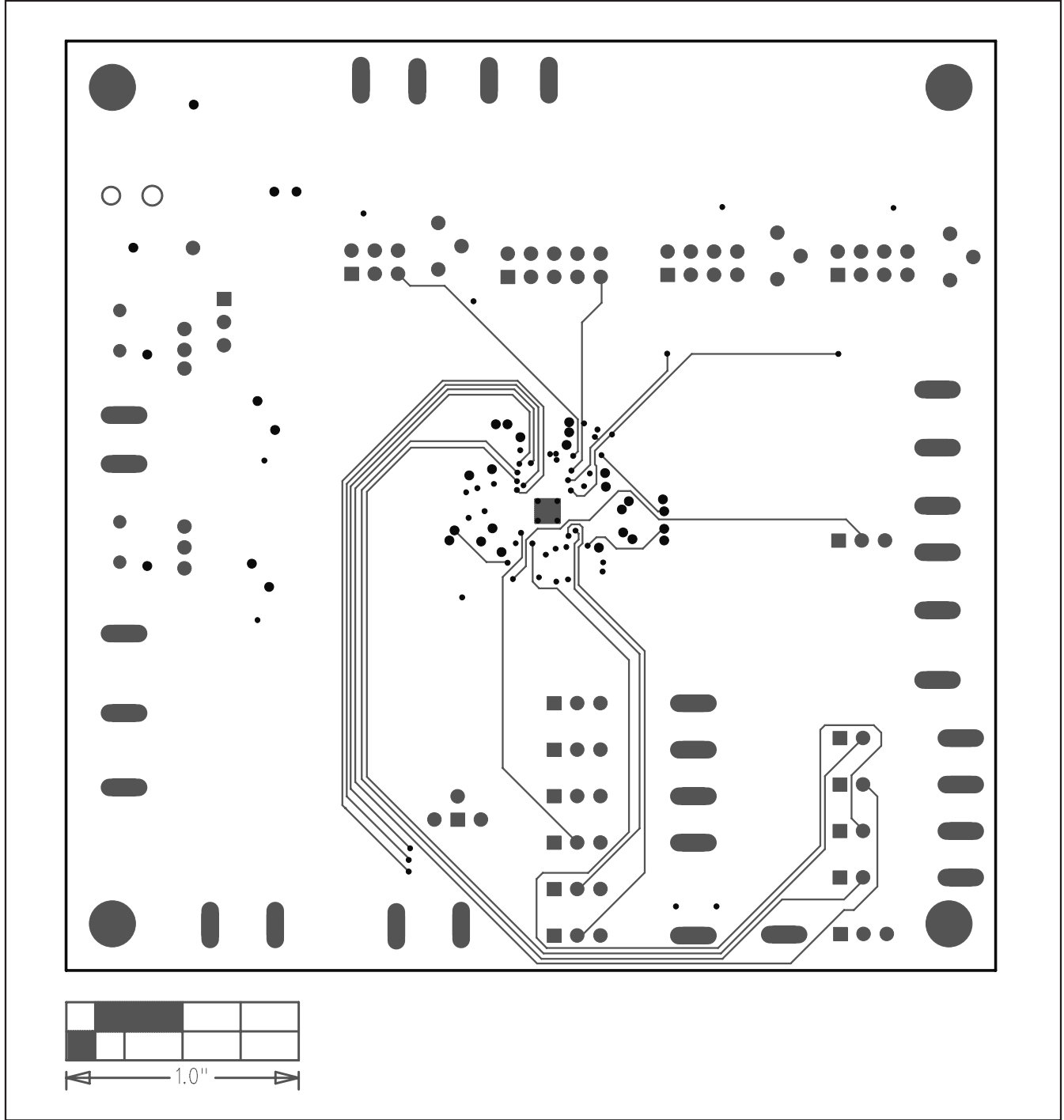

Figure 9. MAX8671 EV Kit PCB Layout—Solder Layer 6

Maxim cannot assume responsibility for use of any circuitry other than circuitry entirely embodied in a Maxim product. No circuit patent licenses are implied. Maxim reserves the right to change the circuitry and specifications without notice at any time.

14 **Maxim Integrated Products, 120 San Gabriel Drive, Sunnyvale, CA 94086 408-737-7600**