

DETAILS

Product Number	FN15264_STELLA-HB-WWW
Family	STELLA
Type	Pack
Color	black
Diameter	90 mm
Height	11,3 mm
Style	round
Optic Material	Silicone
Holder Material	
Fastening	screw
Status	production ready
ROHS Compliant	Yes
Date Updated	2/02/2017



OPTICAL PROPERTIES

LED	Viewing	Light	Effi-	cd/lm	Connector
	Angle	Beam	ciency		
VERO29	103 deg	WWW-class	91 %	0.350	-
Vero SE 29	105 deg	WWW-class	92 %	0.340	-
Vero SE 13	101 deg	WWW-class	90 %	0.370	-
Vero SE 18	101 deg	WWW-class	90 %	0.370	-
VERO18	102 deg	WWW-class	89 %	0.360	-
V10 Gen7	sim: 95	WWW-class	sim: 88 %	sim: 0.430	Bender Wirth: 434 Typ Z1
V22 Gen7	sim: 96	WWW-class	sim: 94 %	sim: 0.457	IDEAL: 50-2204CT
V22 Gen7	sim: 94	WWW-class	sim: 94 %	sim: 0.457	Bender Wirth: 431 Typ Z1
V18 Gen7	sim: 98	WWW-class	sim: 87 %	sim: 0.390	BJB: 47.319.2350
V13 Gen7	sim: 94	WWW-class	sim: 94 %	sim: 0.440	Bender Wirth: 477 Typ Z1
V13 Gen7	sim: 94	WWW-class	sim: 94 %	sim: 0.448	-
CLL02x/CLU02x (LES10)	100 deg	WWW-class	88 %	0.370	-
CLL04x/CLU04x	102 deg	WWW-class	89 %	0.360	-
CLL05x/CLU05x	sim: 97	WWW-class	sim: 87 %	sim: 0.380	-
CXA/B 3590	102 deg	WWW-class	90 %	0.360	-
LUXEON CoB 1216	sim: 99	WWW-class	sim: 87 %	sim: 0.360	-
Fortimo SLM 1211 L19 G6 Poke-In	101 deg	WWW-class	93 %	0.380	-
MJT COB LES 33	101 deg	WWW-class	90 %	0.360	Bender Wirth: 458 Typ L4
MJT COB LES 22	101 deg	WWW-class	89 %	0.360	IDEAL: 50-2204CT
MJT COB LES 22	101 deg	WWW-class	89 %	0.360	Bender Wirth: 431 Typ Z1
MJT COB LES 14.5	101 deg	WWW-class	90 %	0.450	Bender Wirth: 433 Typ Z1
MJT COB LES 14.5	101 deg	WWW-class	87 %	0.400	-

H G F E D C B A

4

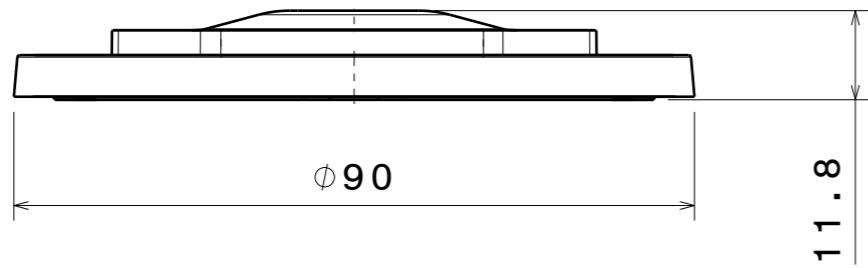

3

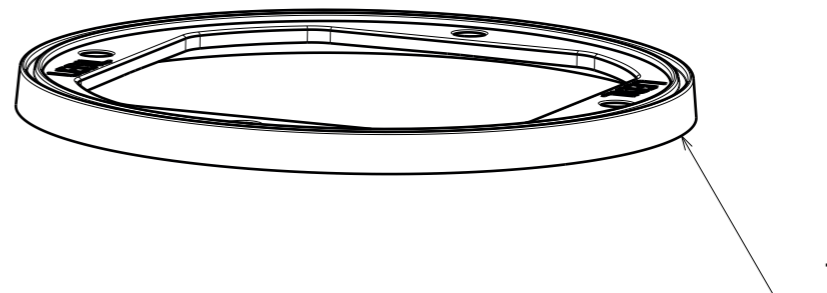

2

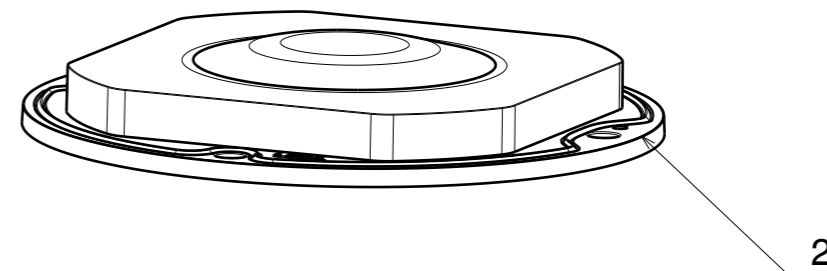
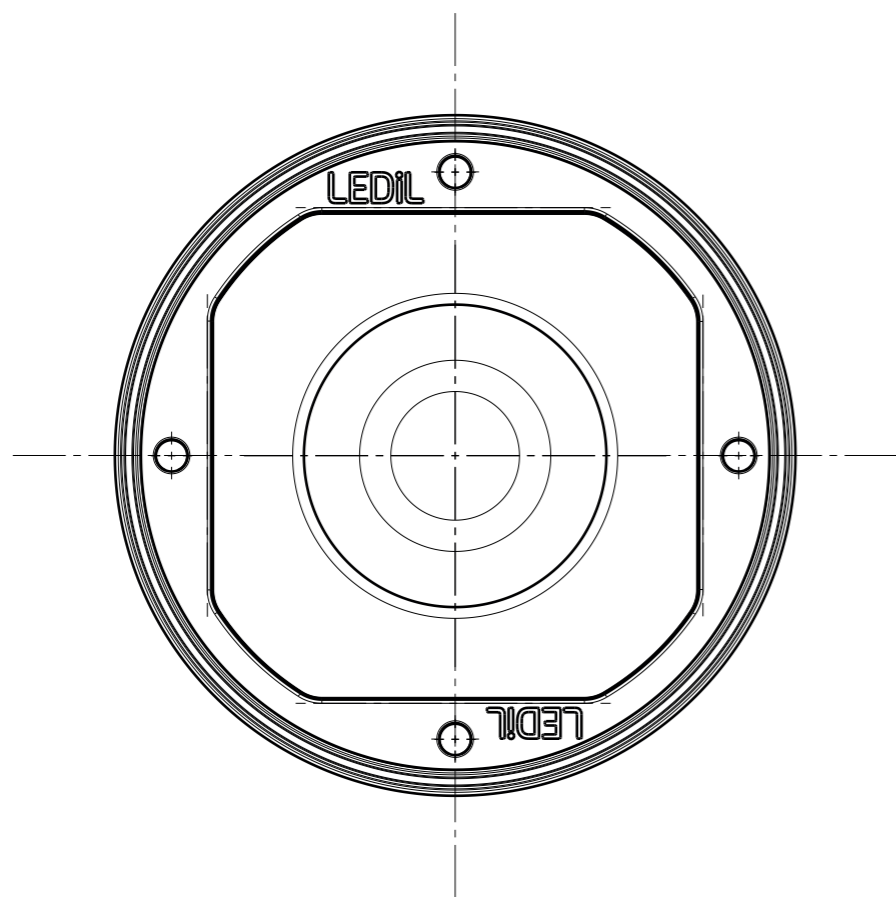

1

NOTE: Maximum recommended tightening torque for STELLA-FRAME is 0,4Nm

INDEX	PART NO	DESCRIPTION	MATERIAL	COLOUR
1	F13322	STELLA-FRAME	PA	black
2	F15263	STELLA-HB-WWW	Silicone	Clear

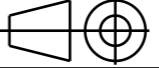
Tolerances if not otherwise shown According to DIN ISO 2768-1 Linear measures: Up to 30mm class M, otherwise class C. According to DIN ISO 2768-2 Form and position: class L		 Ledil Oy Salorankatu 10 FIN 24240 SALO Finland		
THIRD ANGLE PROJECTION: 		DRAWING TITLE FN15264_STELLA-HB-WWW		
This drawing is the property of LEDiL Oy. It may not be reproduced, copied or communicated without a written agreement with LEDiL Oy.		SIZE A3	PART NUMBER FN15264	
		SCALE 1:1	WEIGHT 29,44 g	SHEET 1/1

H G B A

Luminaire: LEDiL Oy FN15264_Stella-HB-WWW_(Vero29)

Lamps: 1 x Bridgelux_Vero29_(BXRC-50C10K0-L-04)_1406.19lm@250mA_P=8.66781W_I=0.250A

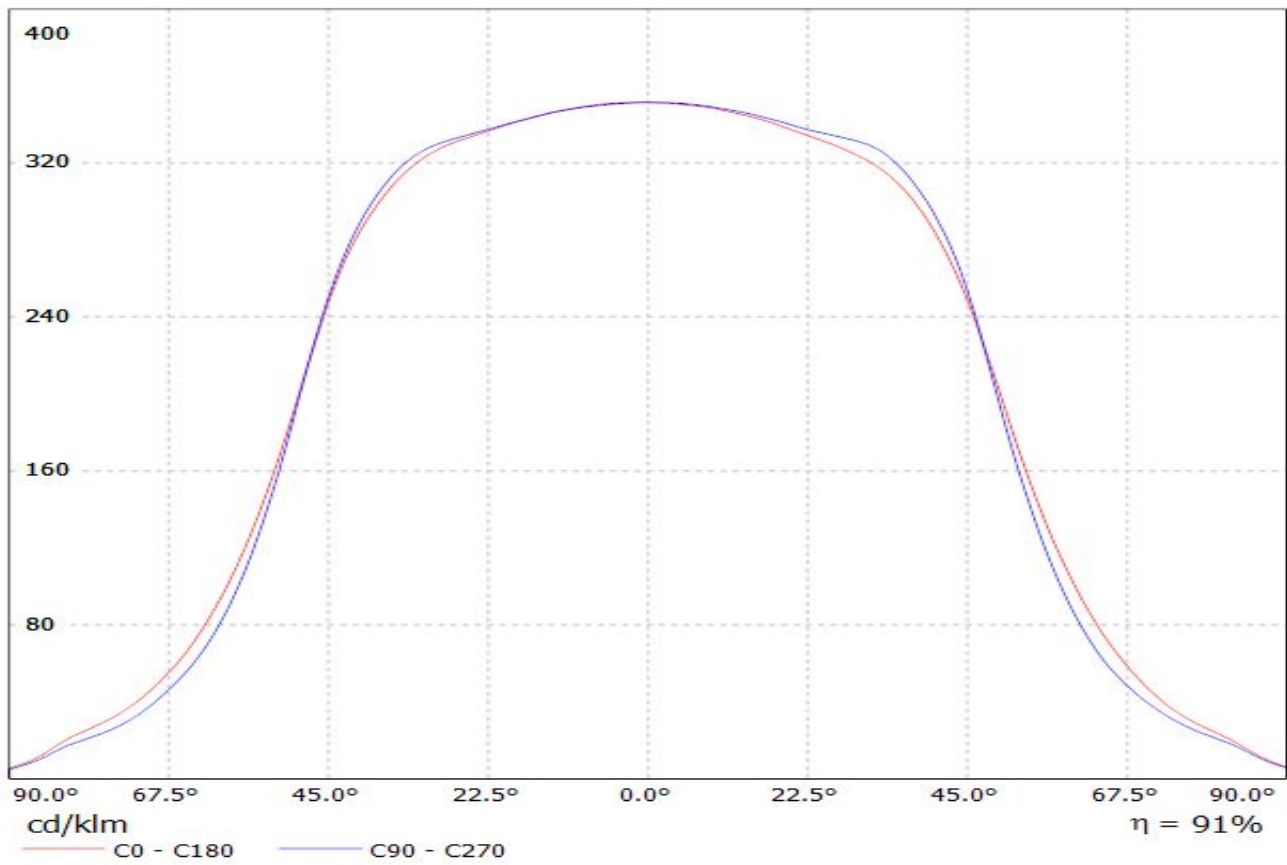

Luminaire: Ledil FN15264_STELLA-HB-WWW_(Vero29_SE_Gen7)
Lamps: 1 x Vero29_SE_Gen7_1750.87lm@250mA_P=8.5765_I=0.25A

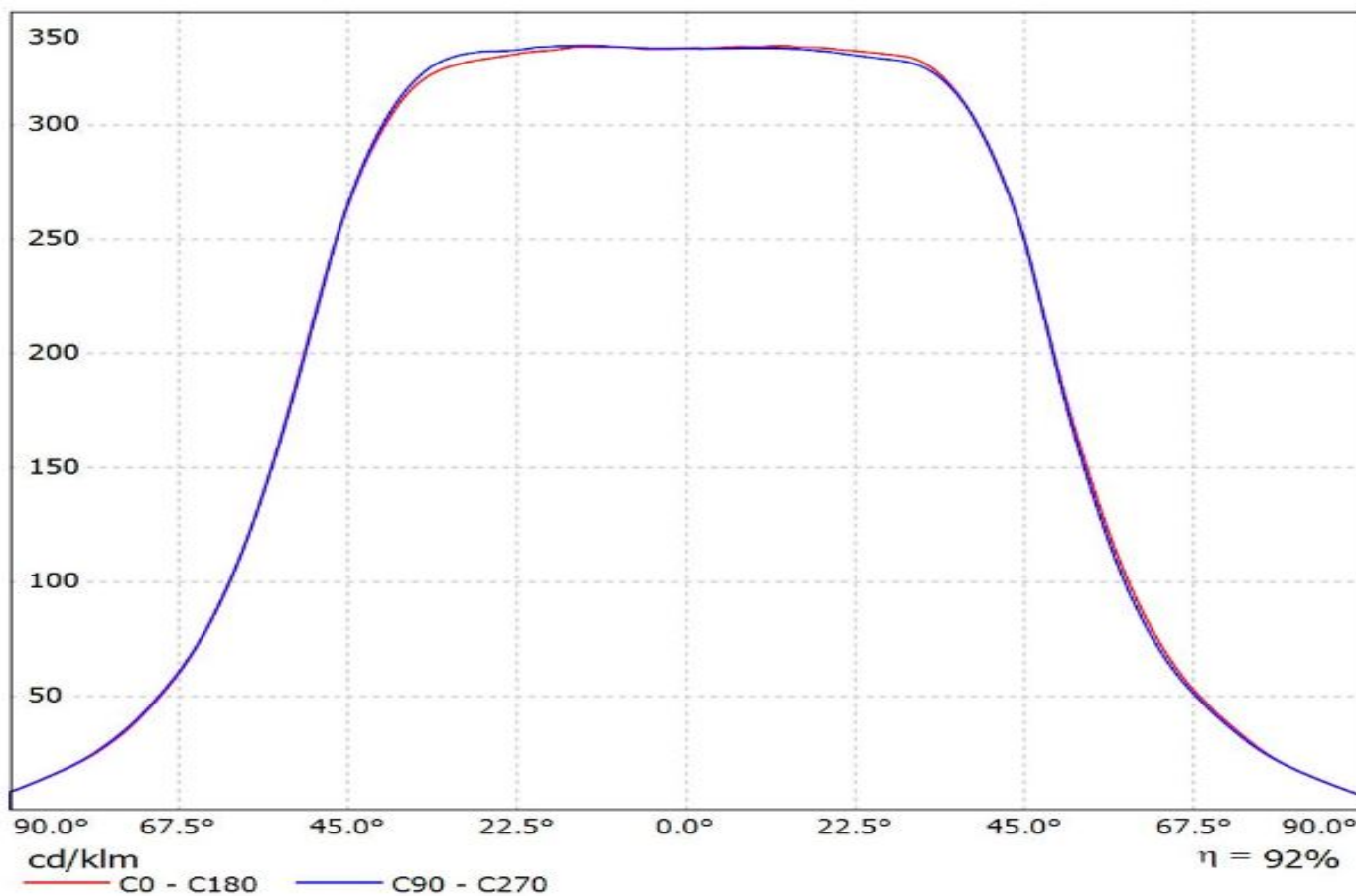

Luminaire: Ledil FN15264_STELLA-HB-WWW (Vero_13_SE)
Lamps: 1 x Bridgelux_Vero_13_SE_(BXRC-30E2000-C-73-SE)
_1310.97lm@250mA_P=8.17575W_I=0.25A

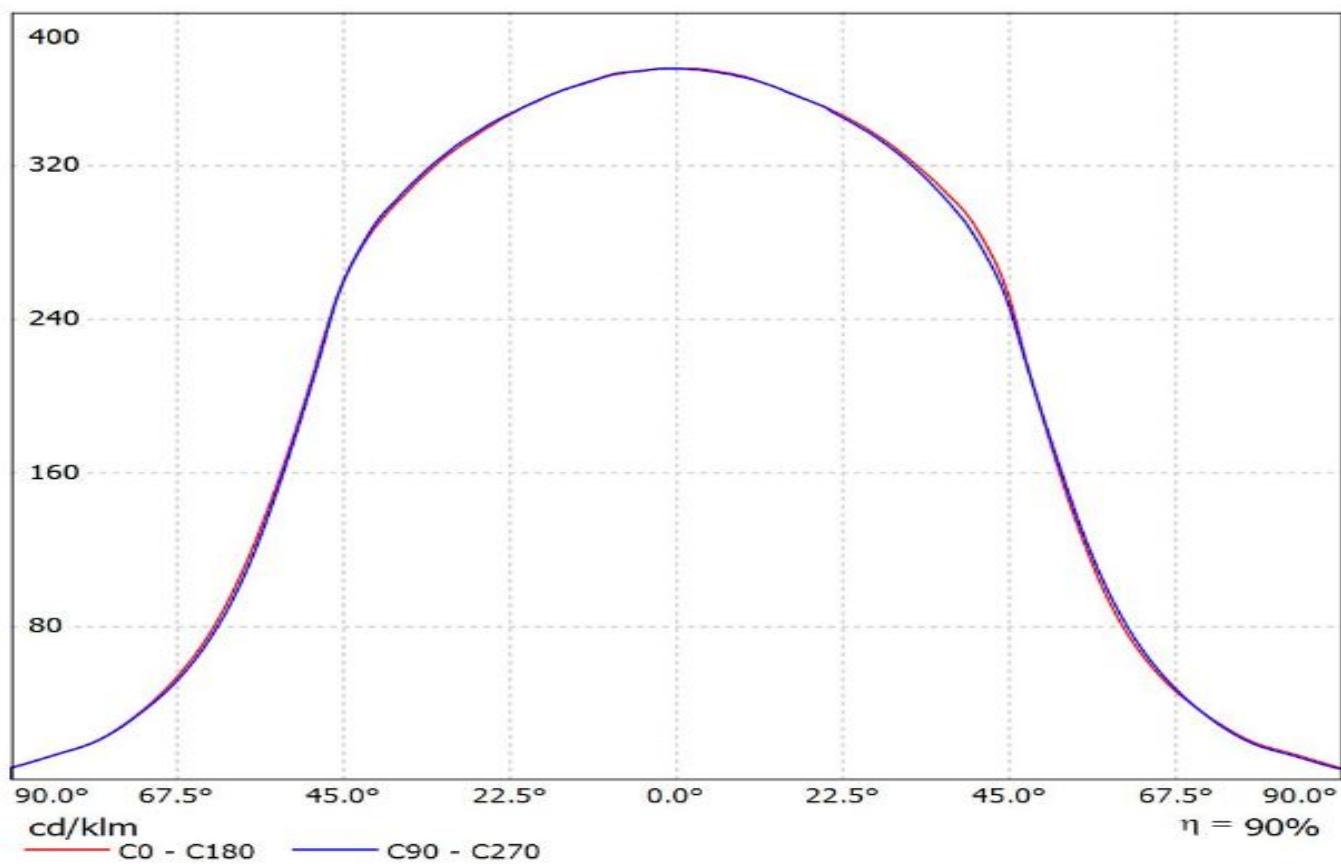

Luminaire: LEDiL Oy FN15264_STELLA-HB-WWW_(VERO18_SE)
Lamps: 1 x Bridgelux_VERO18_SE_(BXRC-30E4000-C-73-SE)
_1335.46lm@250mA_P=7.9961W_I=0.25A

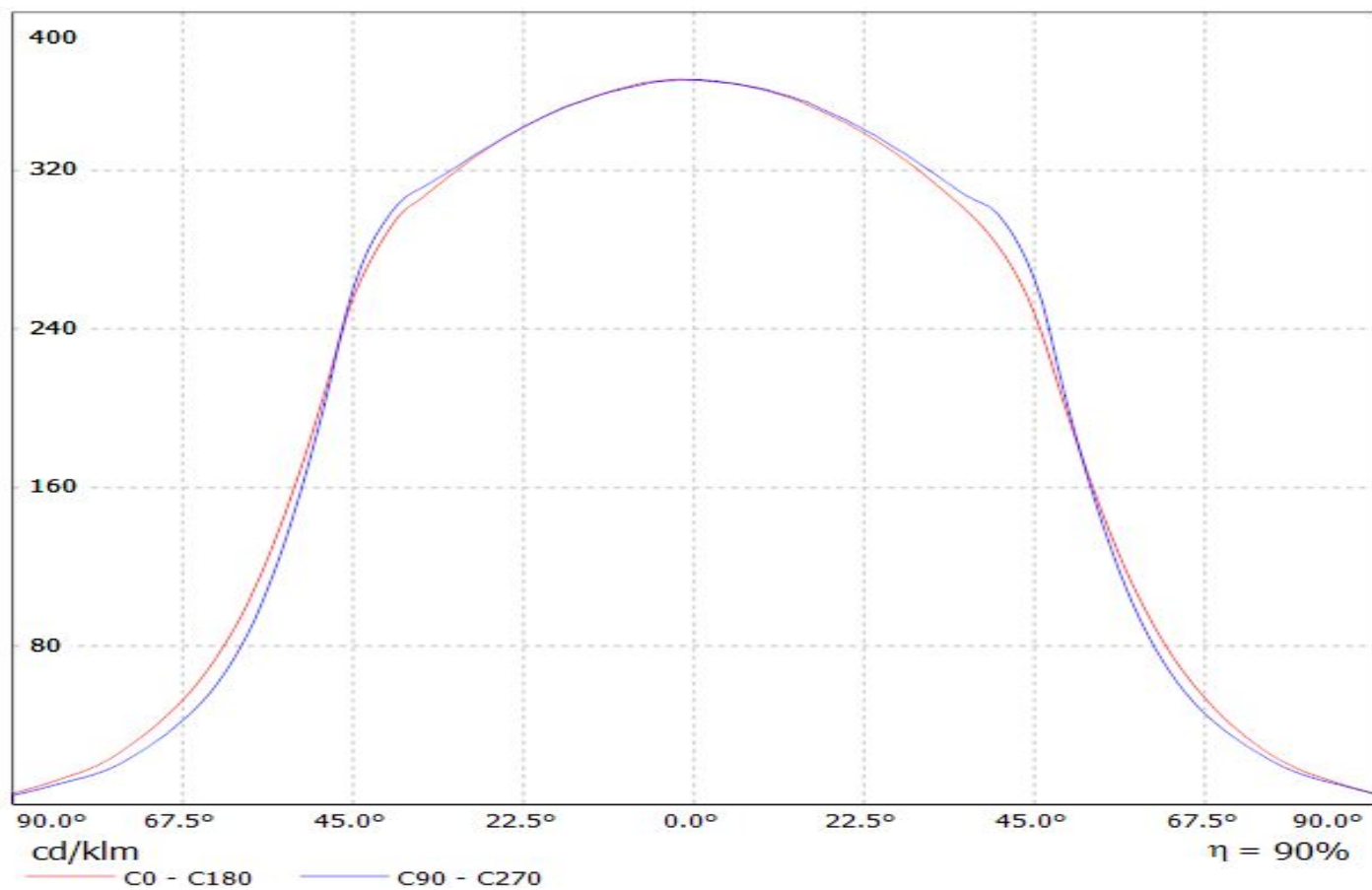

Luminaire: LEDiL Oy FN15264_STELLA-HB-WWW_(VERO18)

Lamps: 1 x Bridgelux_VERO18_(BRXE-30E4000-F-23)_CCT=3000K_1014.16lm@250mA_P=6.79456W_I=0.25A

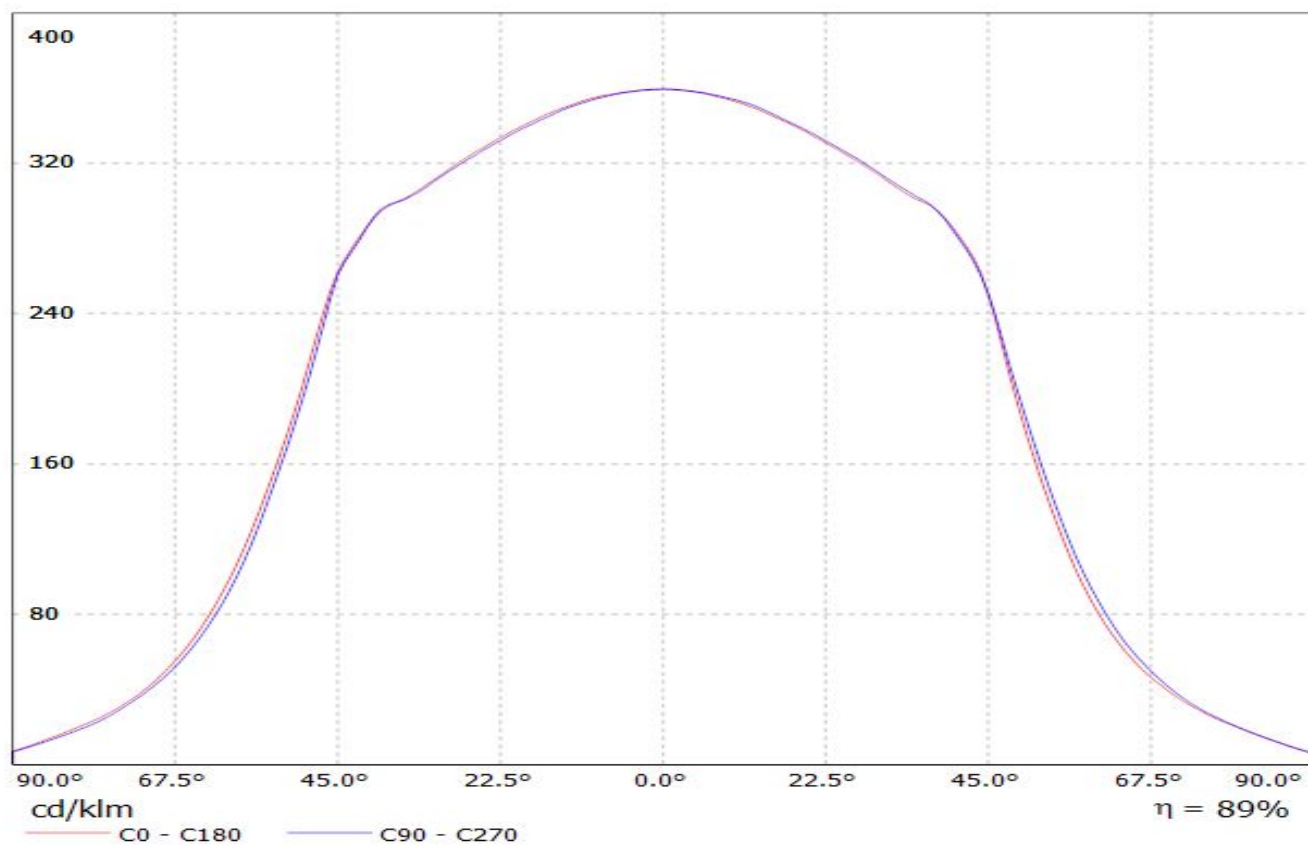

Luminaire: Ledil Oy FN15264_STELLA-HB-WWW+_Bender&Wirth - LED holder 434 Typ Z1_BRIDGELUX_V10_Gen7_SIMULATED
Lamps: 1 x BRIDGELUX V10 Gen7

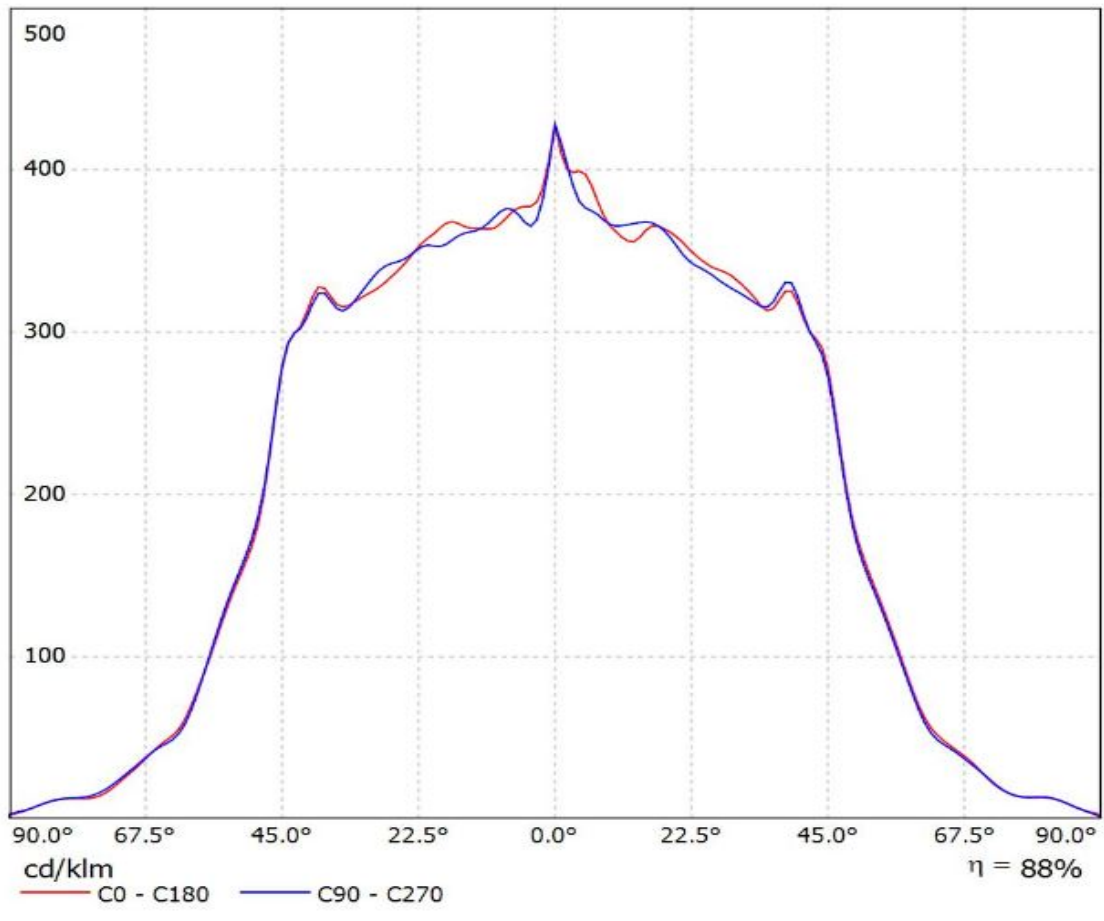

Luminaire: Ledil Oy FN15264_STELLA-HB-WWW_Bridgelux_V22_Gen7_SIMULATED
Lamps: 1 x Bridgelux V22 Gen7

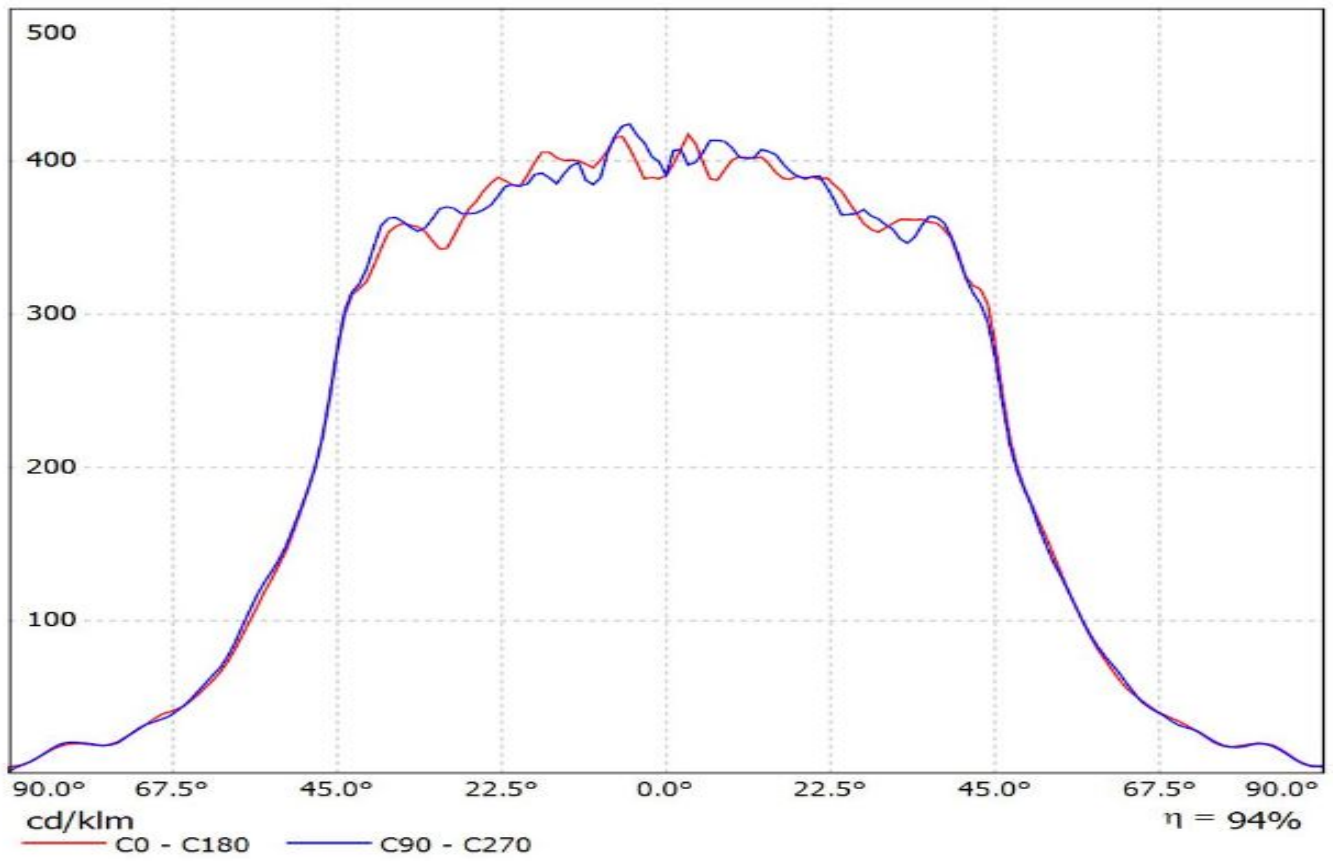

Luminaire: Ledil Oy FN15264_STELLA-HB-WWW_Bridgelux_V22_Gen7_SIMULATED
Lamps: 1 x Bridgelux V22 Gen7

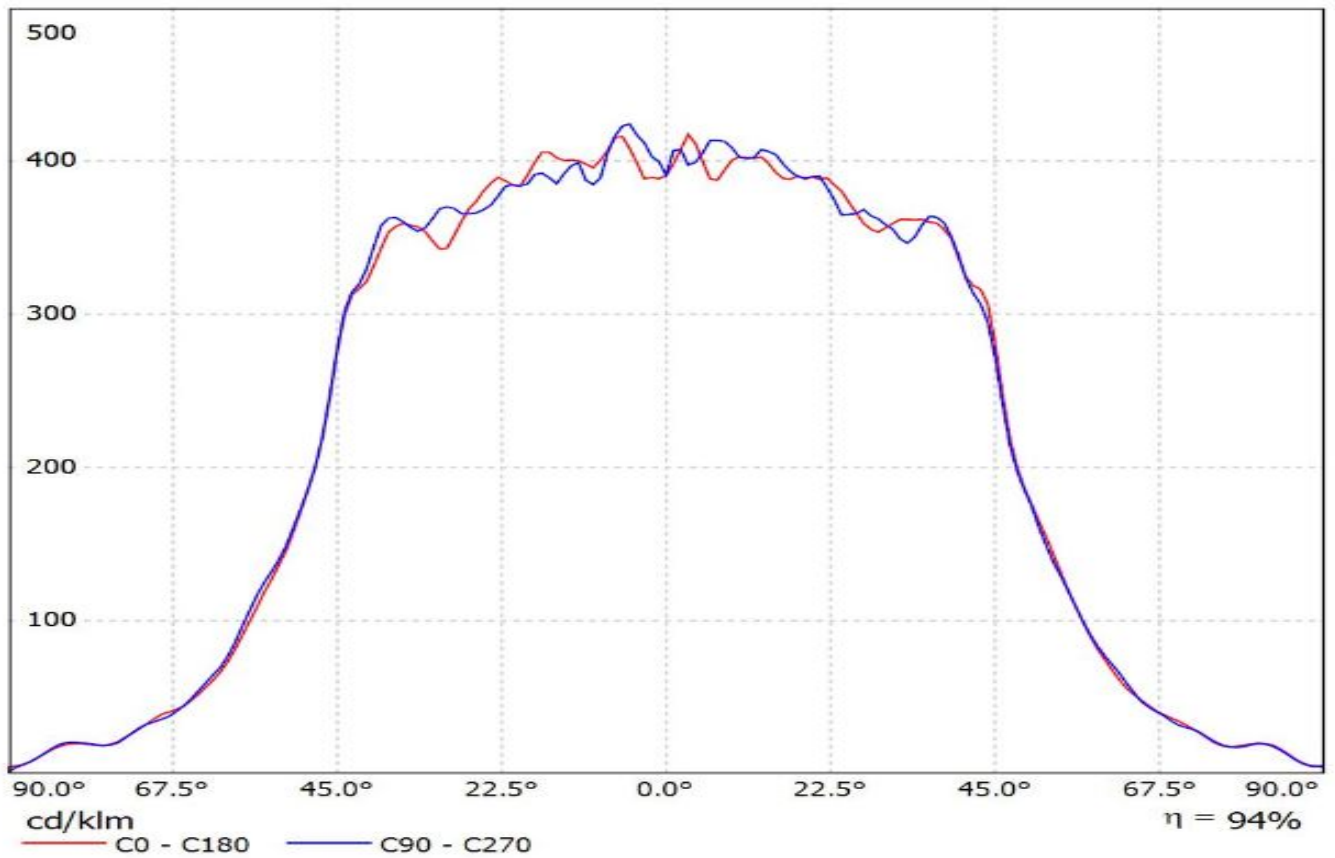

Luminaire: Ledil Oy FN15264_STELLA-HB-WWW+_BJB_47_319_2350_BRIDGELUX_V18_Gen7_SIMULATED
Lamps: 1 x BRIDGELUX V18 Gen7

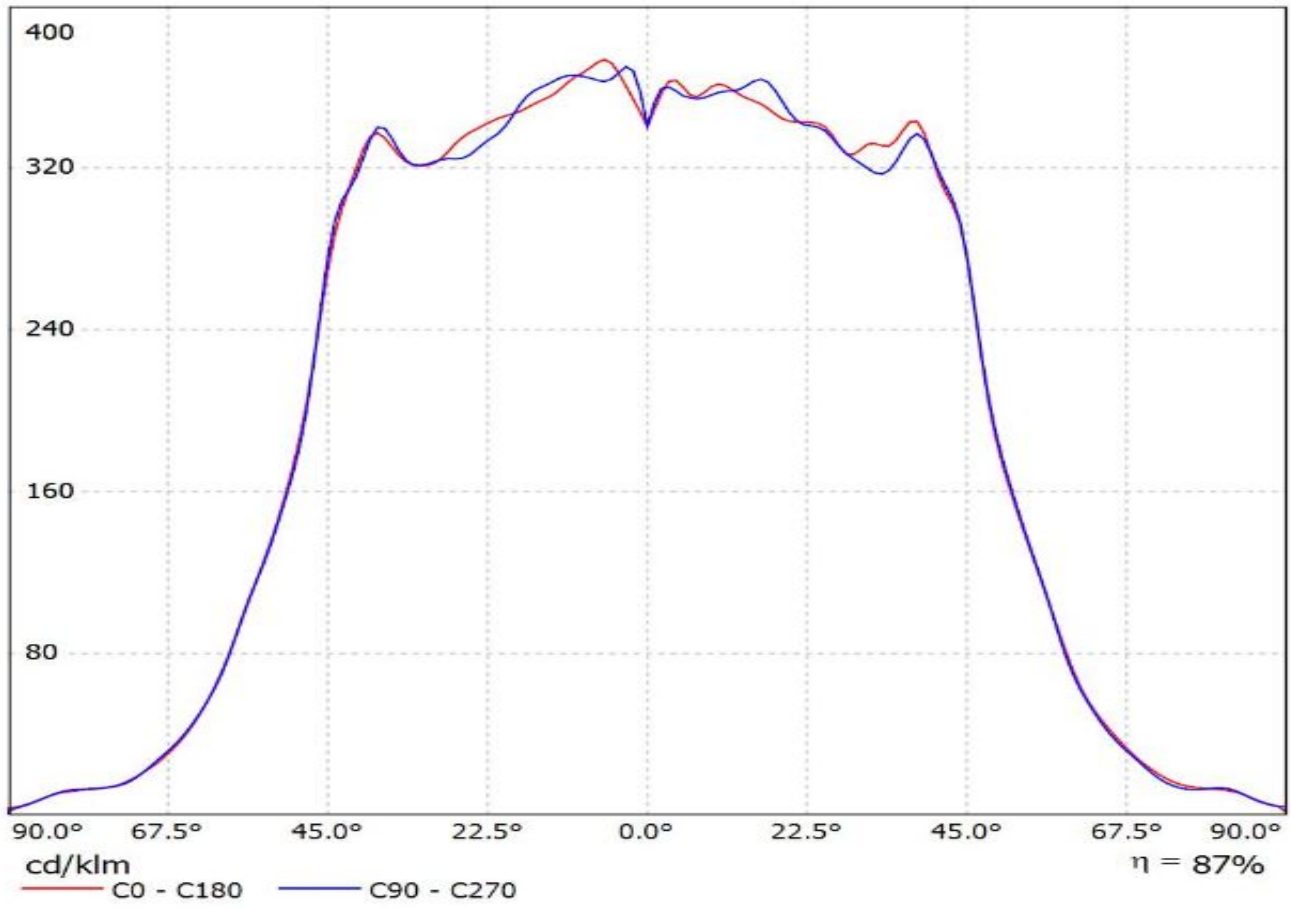

Luminaire: LEDiL Oy FN15264_STELLA-HB-WWW_(CLL020)

Lamps: 1 x Citizen_CLL020_(-1203A1)_626.474lm@180mA_CCT=3215K_P=6.63588W_I=0.18A

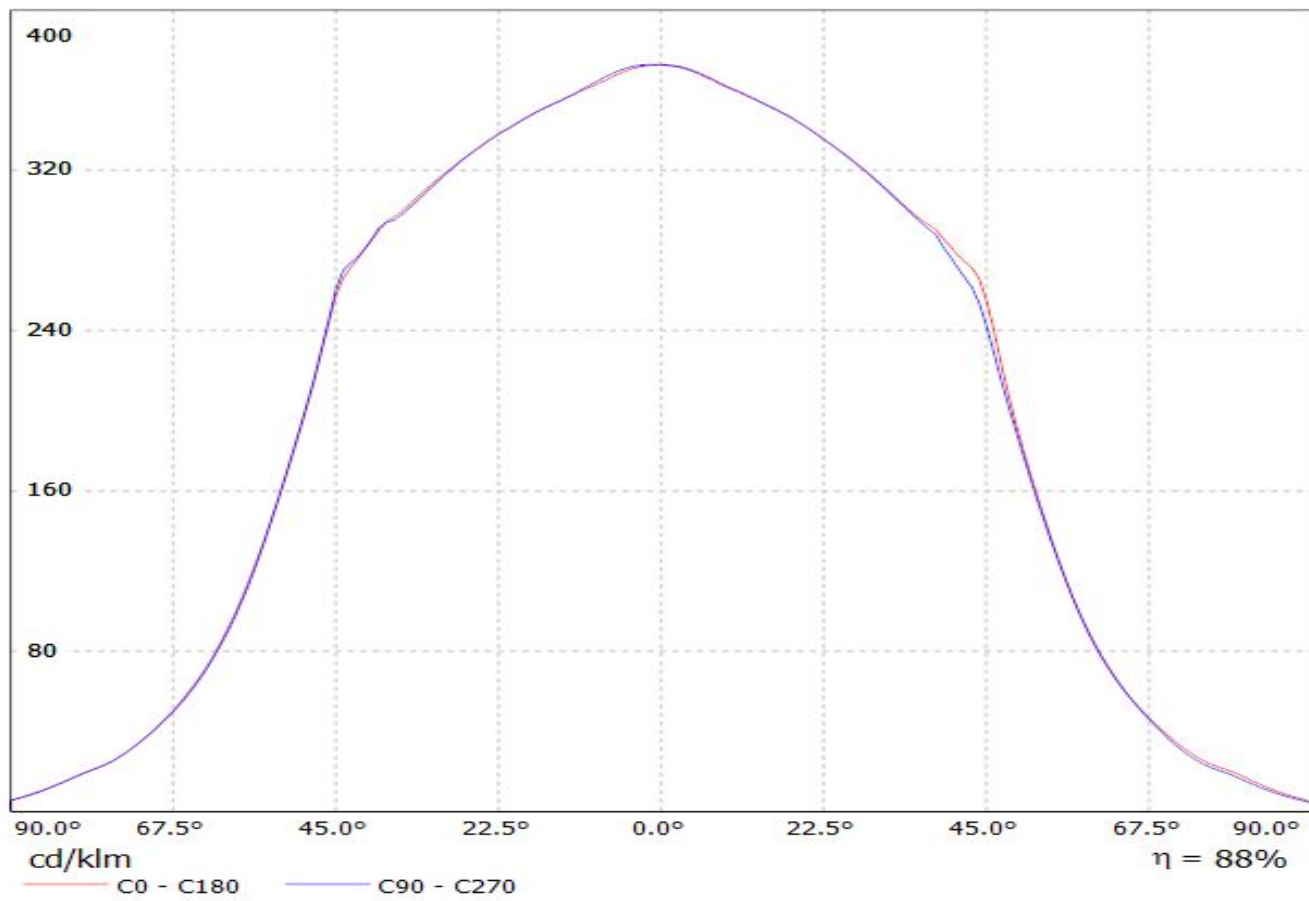

Luminaire: LEDiL Oy FN15264_STELLA-HB-WWW_(CLU046)

Lamps: 1 x Citizen_CLU046_(-1212C1-303M2G2)_1373.06lm@250mA_CCT3000K_P=8.08253W_I=0.25A

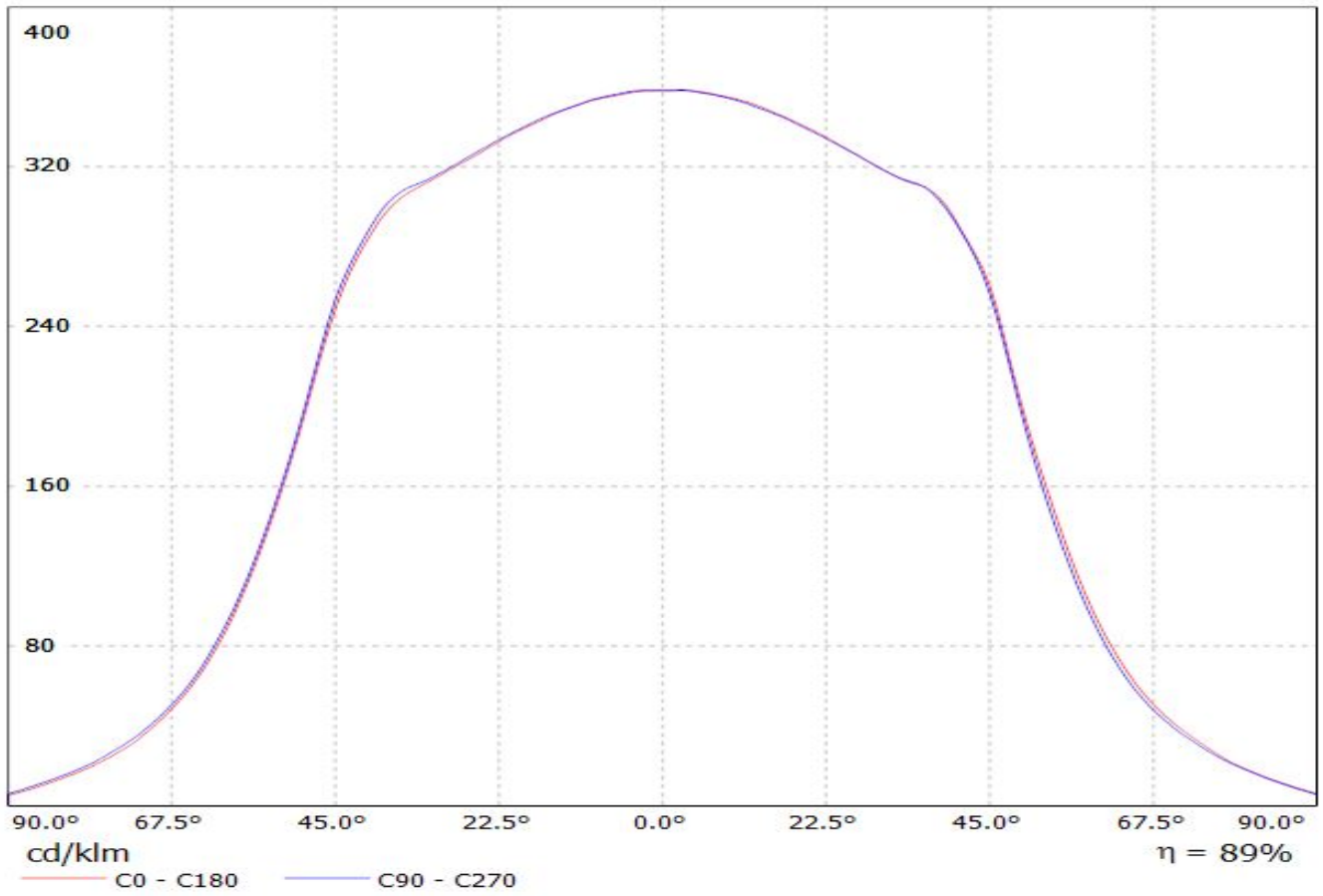

Luminaire: Ledil Oy FN15264_STELLA-HB-WWW_CLU058_SIMULATED
Lamps: 1 x Citizen CLU058 (3618C4)

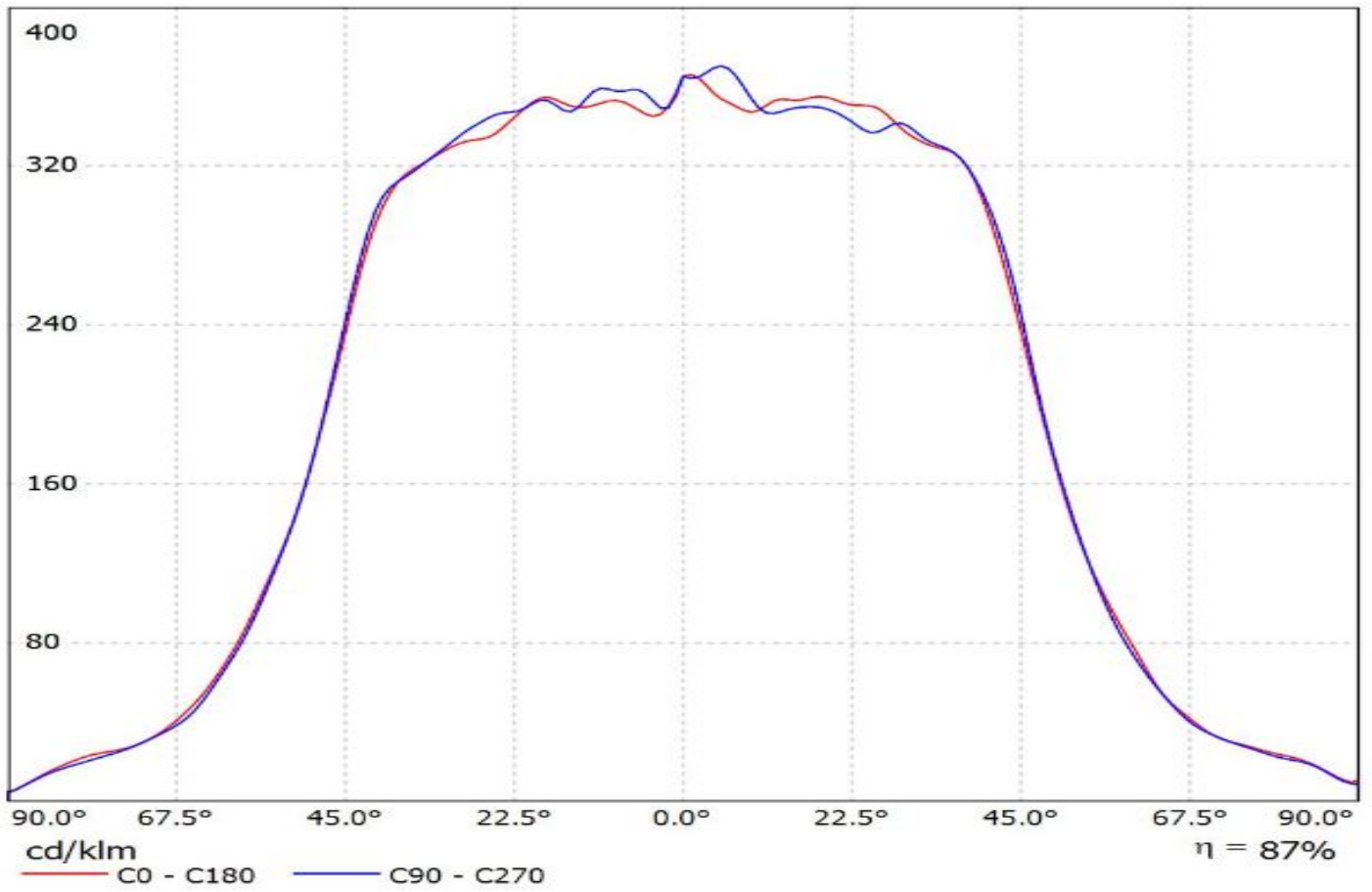

Luminaire: LEDiL Oy FN15264_STELLA-HB-WWW_(CXB3590)

Lamps: 1 x Cree_CXB3590_(CXB2590-40G-C0-N0H-0001)_1518.77lm@250mA_P=7.90792W_η=0.250A

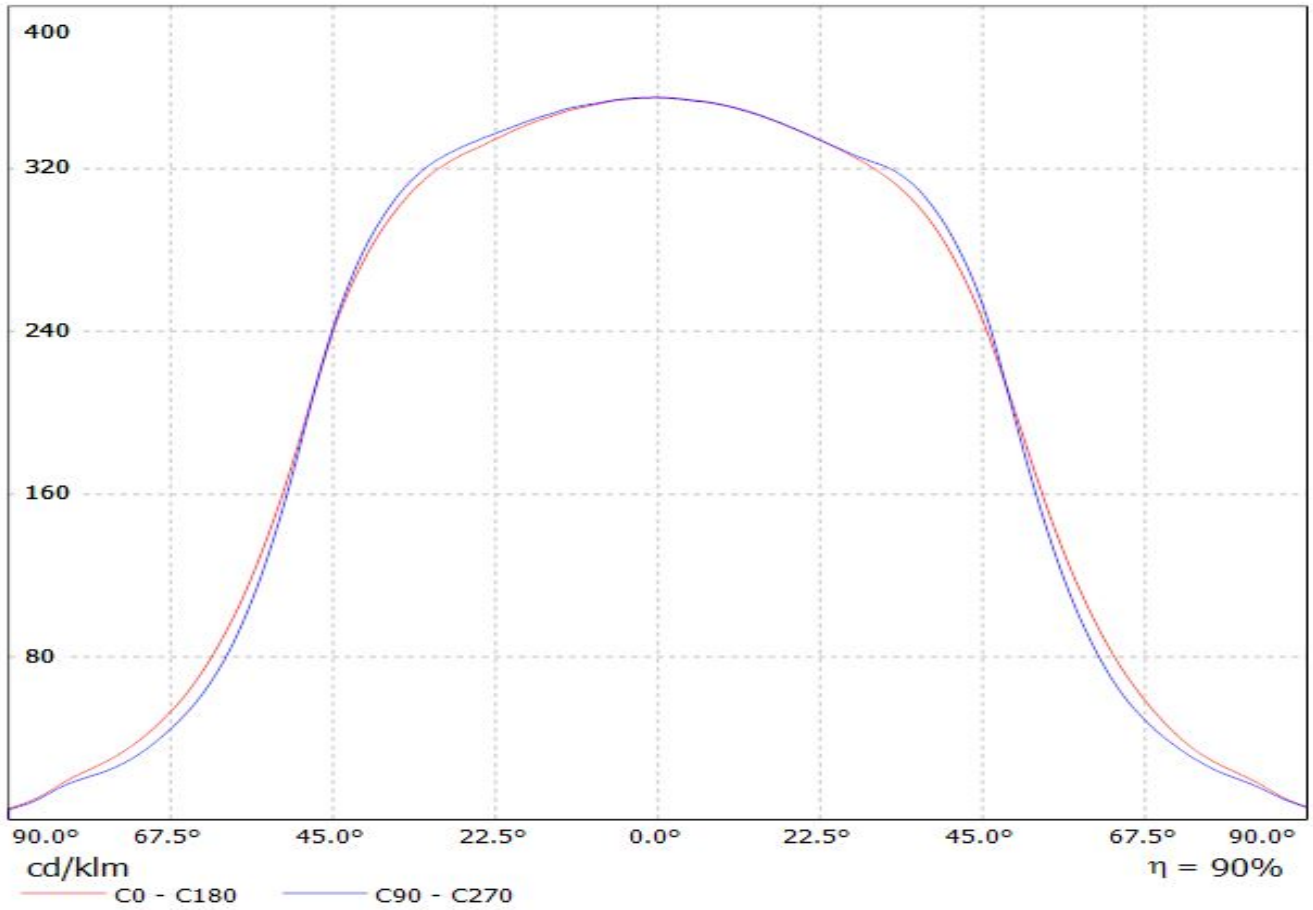

Luminaire: Ledil Oy FN15379_STELLA-VSM_(Luxeon_CoB_1216)_(431_Typ_Z1)_SIMULATED
Lamps: 1 x Lumileds Luxeon CoB 1216 + Bender & Wirth 431 Type Z1

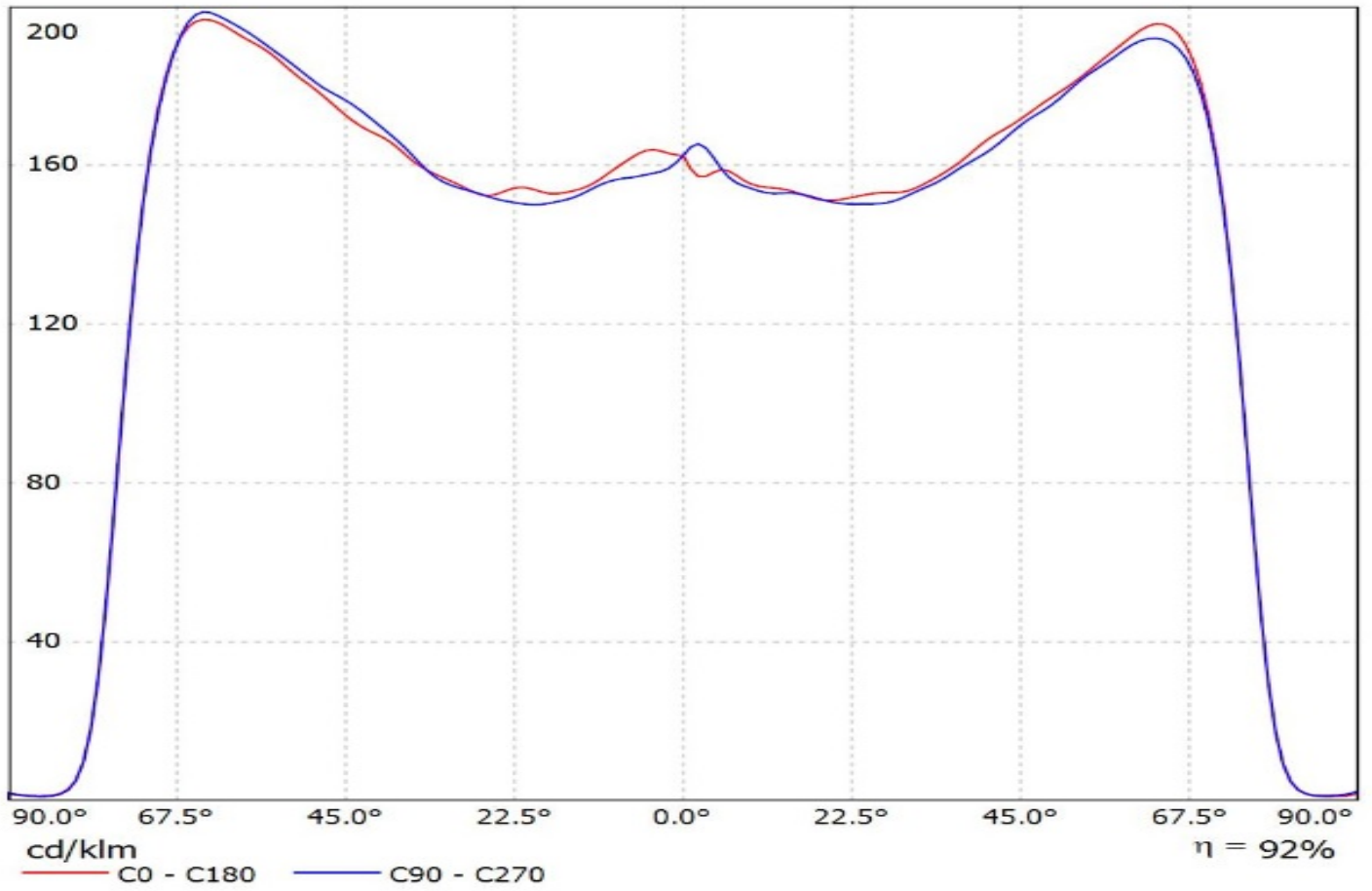

Luminaire: LEDiL Oy FN15264_STELLA-HB-WWW_(SLM_1211_L19_G6)

Lamps: 1 x Philips_Fortimo_SLM_1211_L19_G6_Poke-In_1152.17lm@250mA_P=8.10051W_I=0.25A

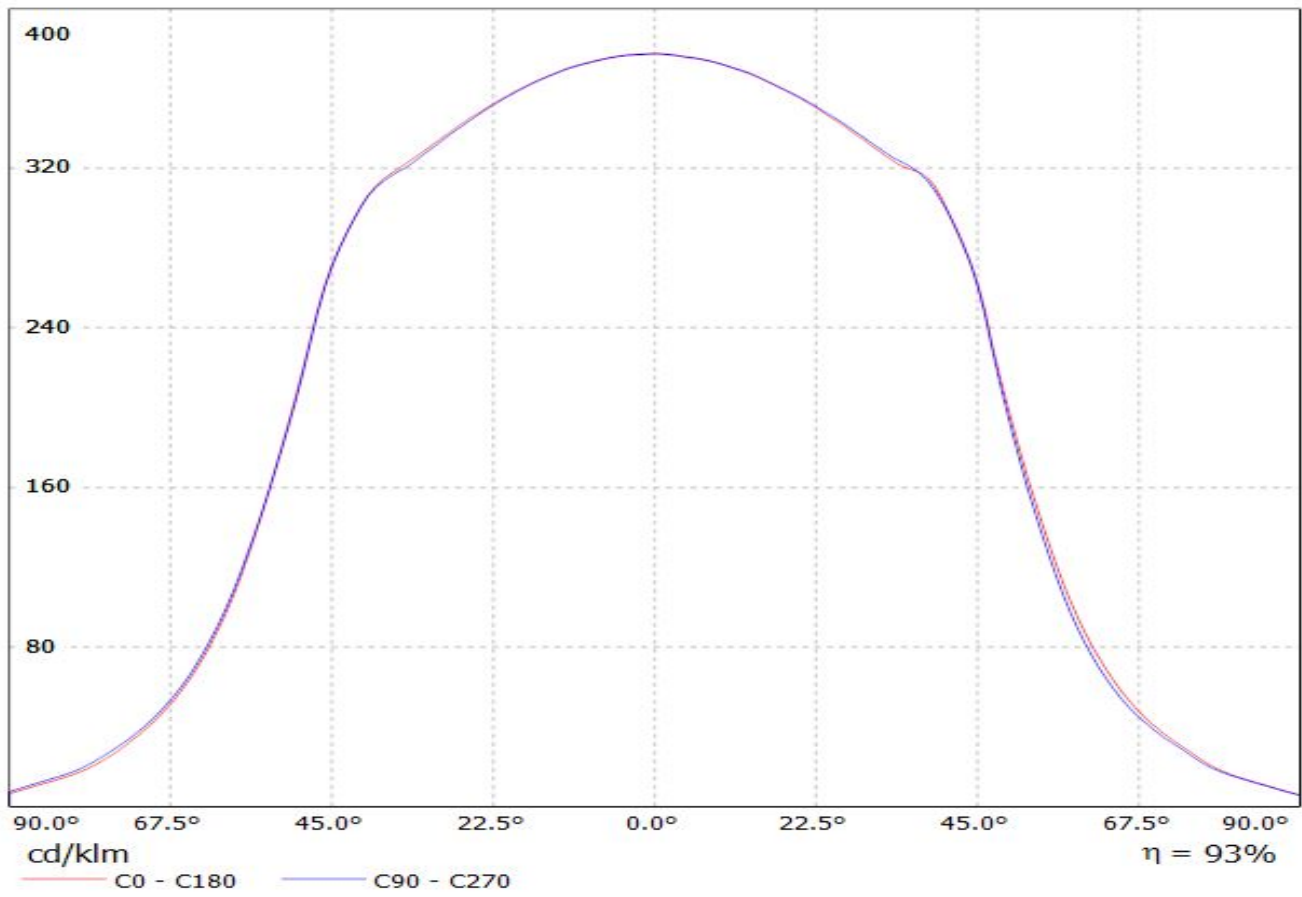

Luminaire: Ledil FN15264_STELLA-HB-WWW_(MJT_180W_Les32,8)_+458TypL4

Lamps: 1 x Seoul_MJT_180W_Les32,8mm_(SAWx33GCA)_+458TypL4_3749.72lm@250mA_P=20.9727W_I=0.25A

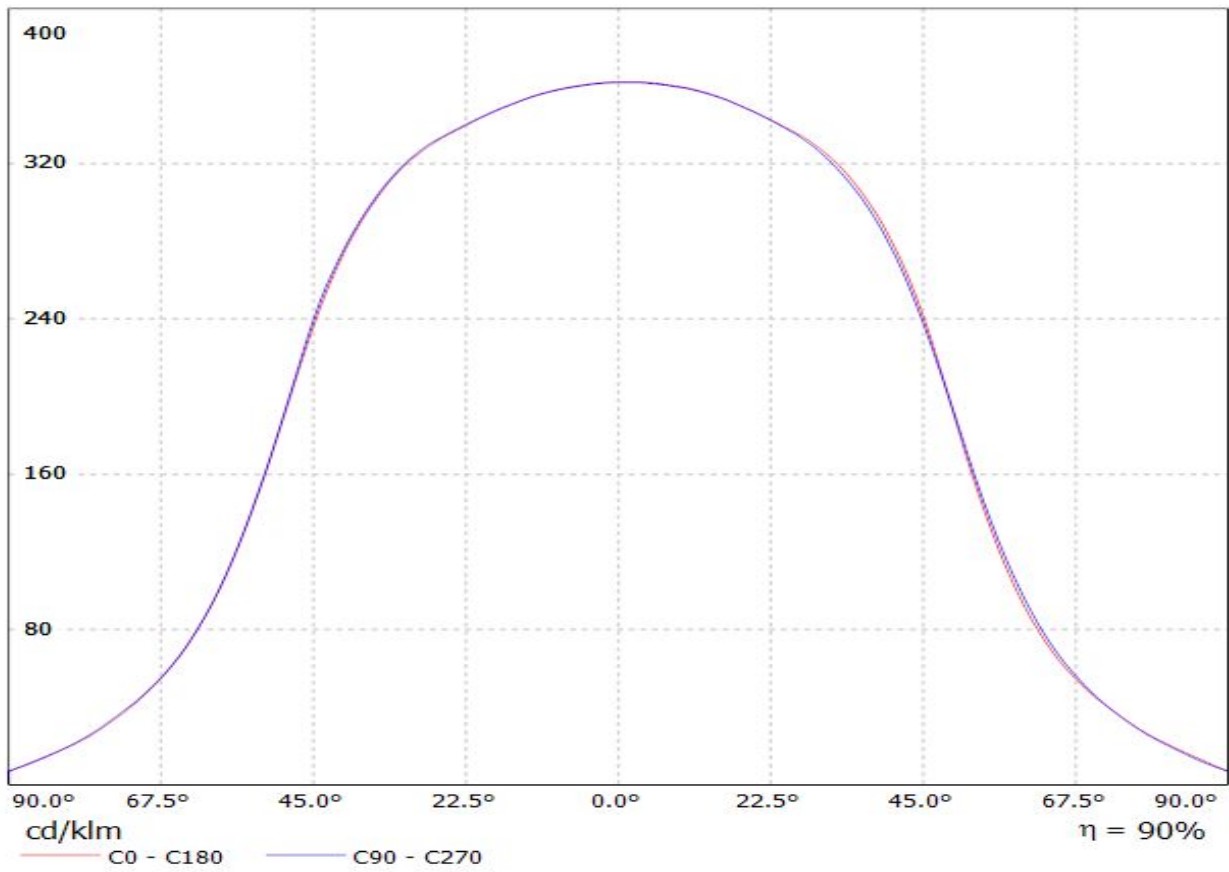

Luminaire: Ledil FN15264_STELLA-HB-WWW_(MJT_80W_Les22)_+Ideal_50-2204CT
Lamps: 1 x Seoul_MJT_80W_Les22mm_(SAWx22AAA)_+Ideal_50-2204CT_2497.65lm@250mA_P=13.3118W_I=0.25A

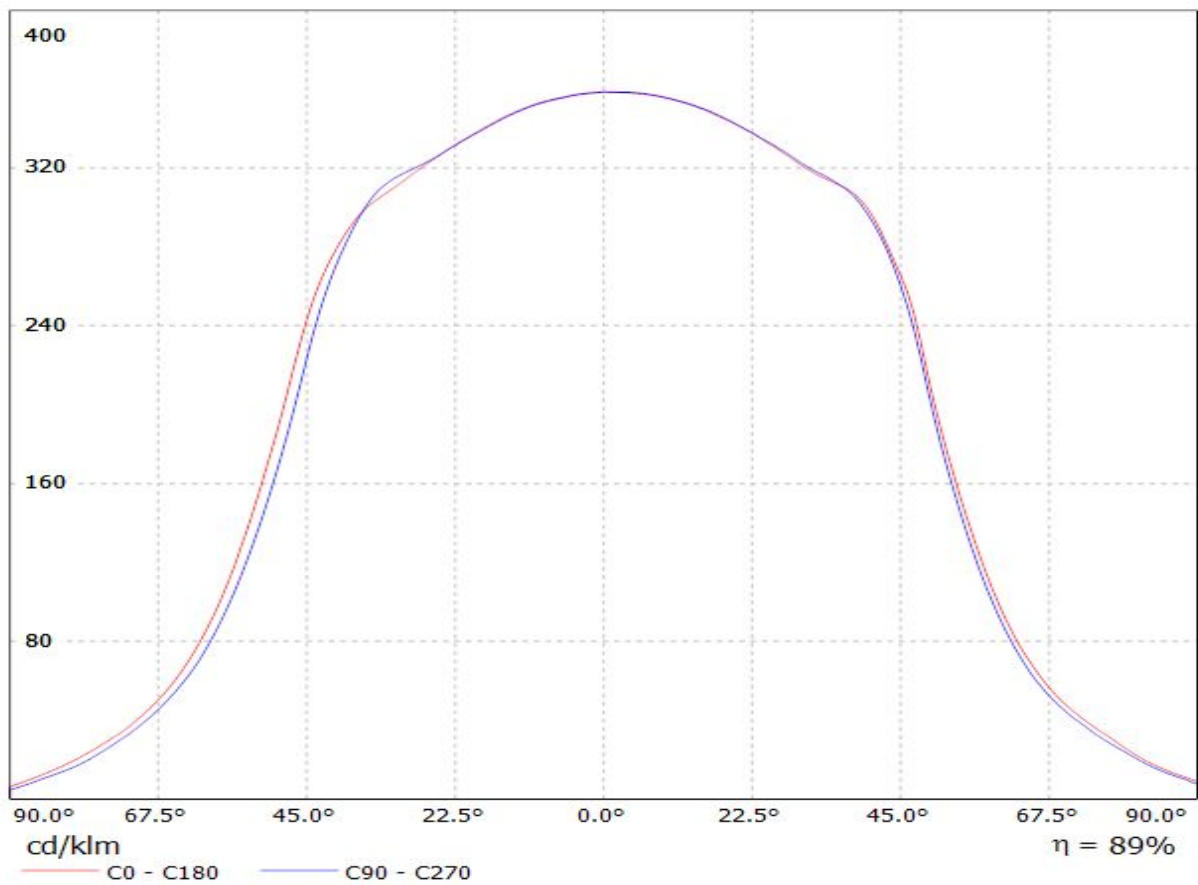

Luminaire: Ledil FN15264_STELLA-HB-WWW_(MJT_80W_Les22)_+431TypZ1

Lamps: 1 x Seoul_MJT_80W_Les22mm_(SAWx22AAA)_+431TypZ1_2501.46lm@250mA_P=13.317W_I=0.25A

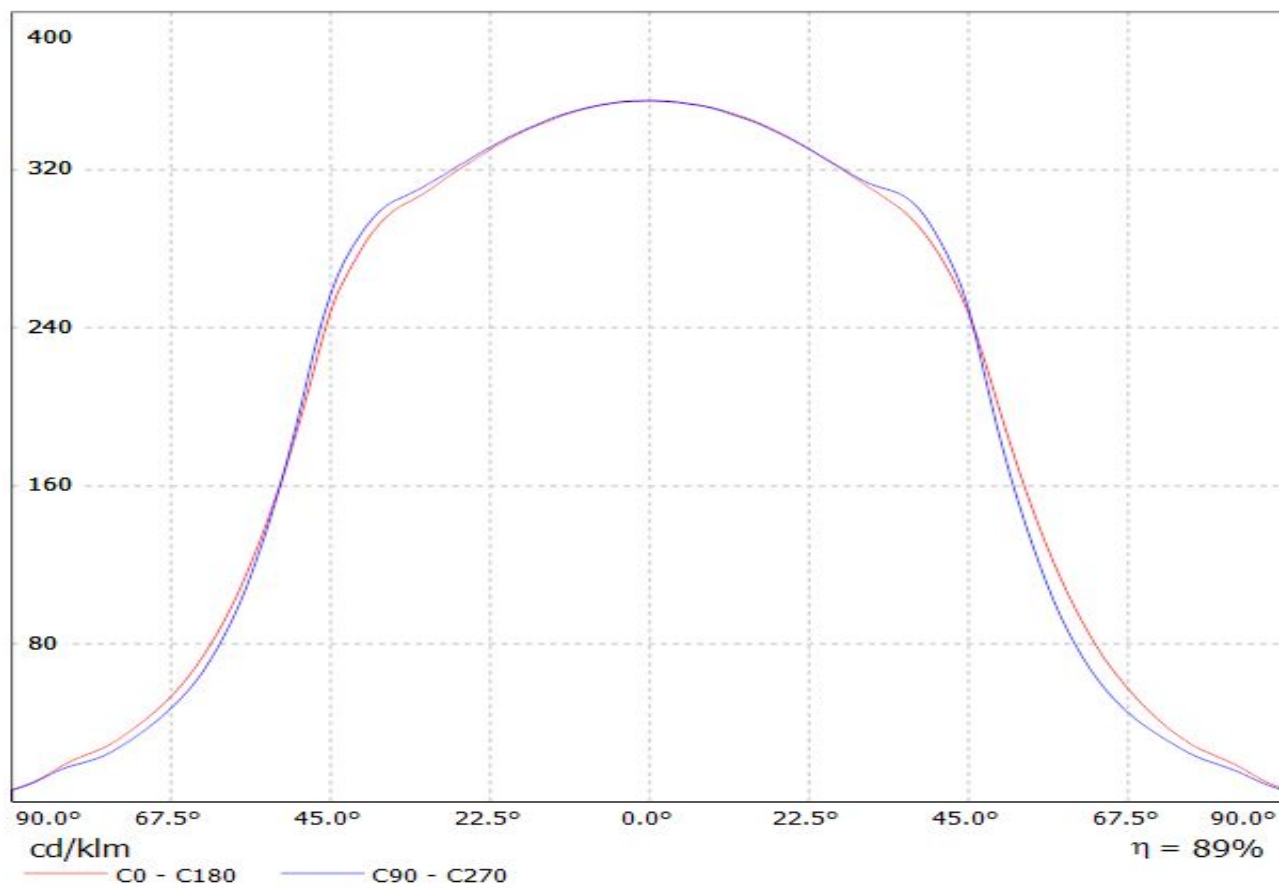

Luminaire: Ledil FN15264_STELLA-HB-WWW_(MJT_30W_Les14,5)_+433_Typ_Z1
Lamps: 1 x Seoul_MJT_30W_Les14,5mm_(SAWx1566A)_433_Typ_Z1_1343.97lm@250mA_P=8.2295W_η=0.25A

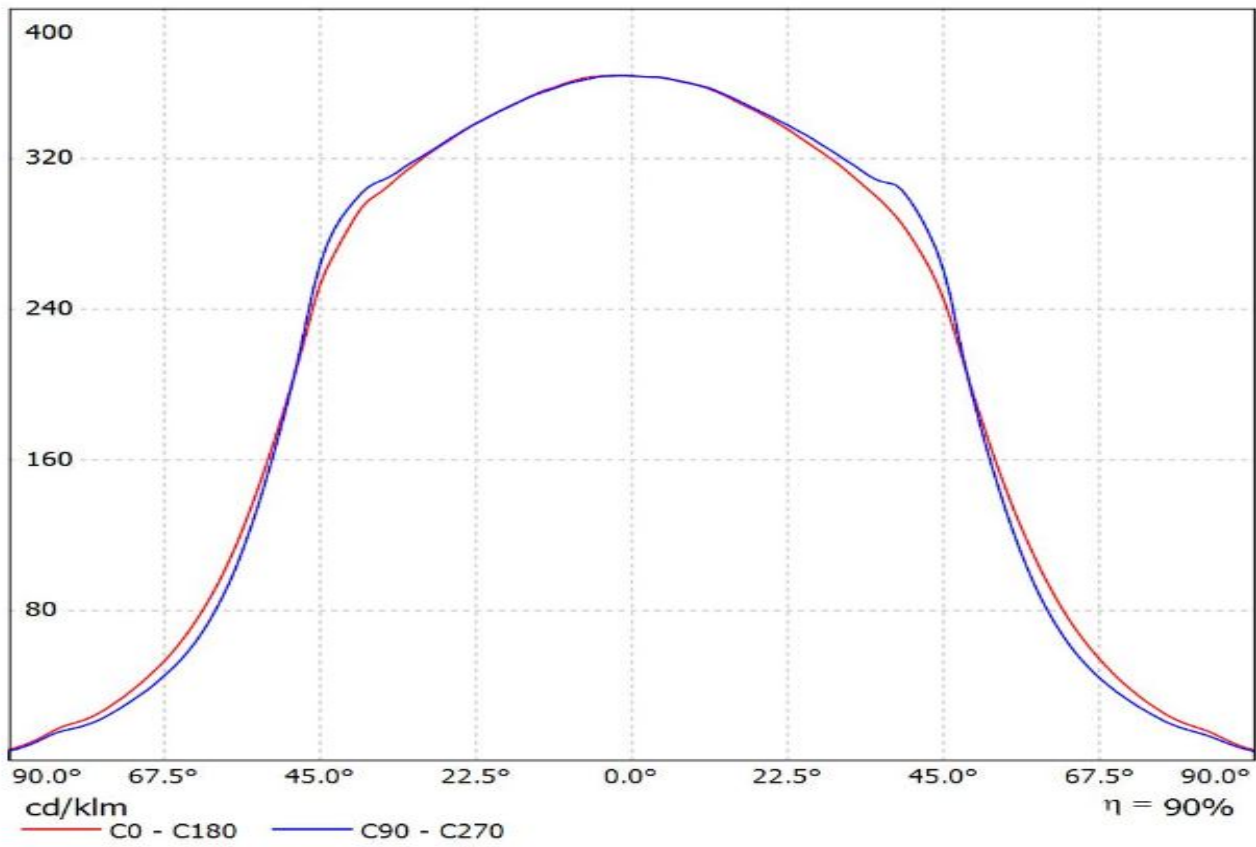

Luminaire: Ledil FN15264_STELLA-HB-WWW_(MJT_30W_Les14,5)

Lamps: 1 x Seoul_MJT_30W_Les14,5mm_(SAWx1566A)_1353.32lm@250mA_P=8.20525W_I=0.25A

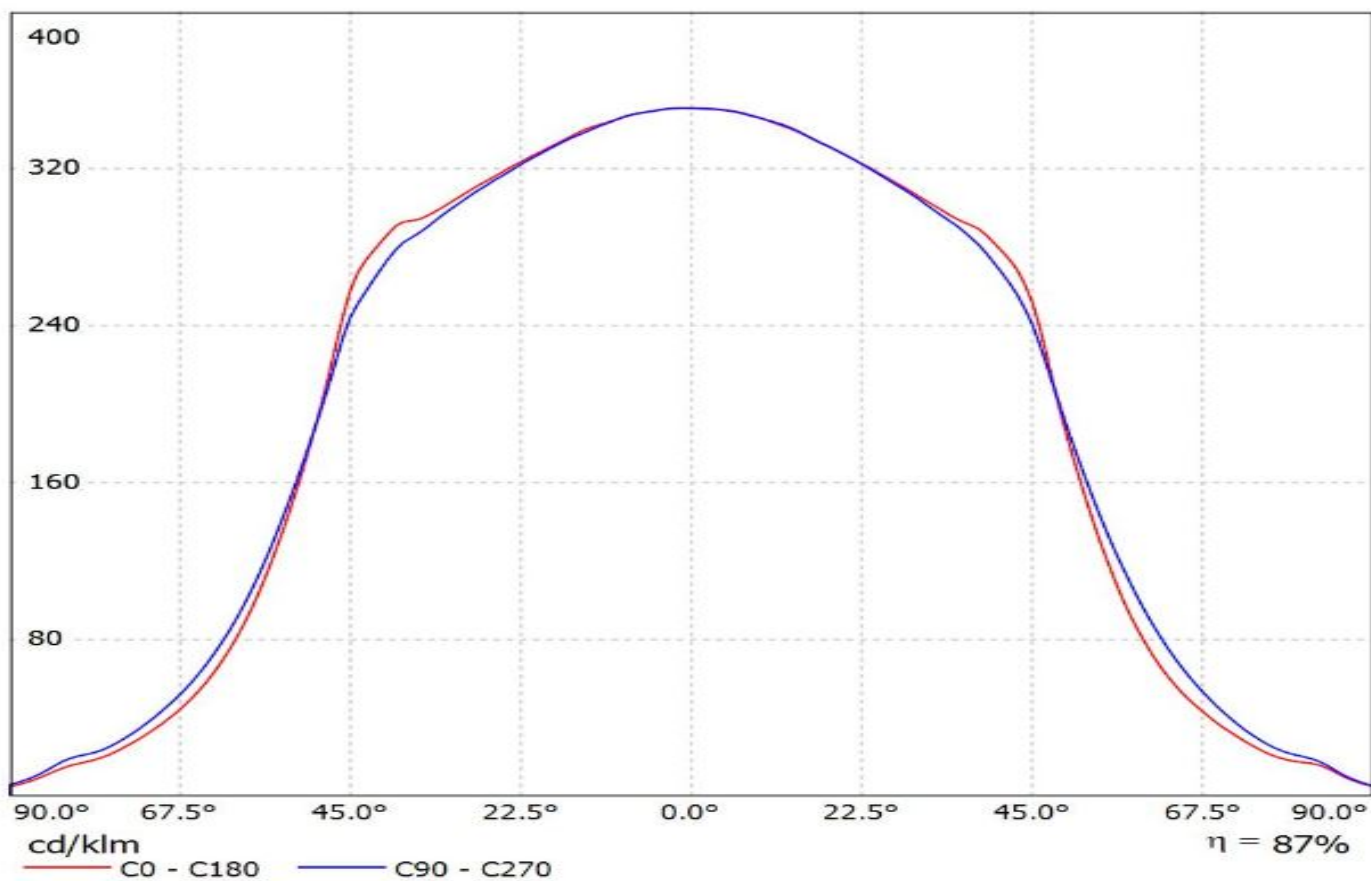

Luminaire: LEDiL Oy FN15264_Stella-HB-WWW_(Vero29)

Lamps: 1 x Bridgelux_Vero29_(BXRC-50C10K0-L-04)_1406.19lm@250mA_P=8.66781W_I=0.250A

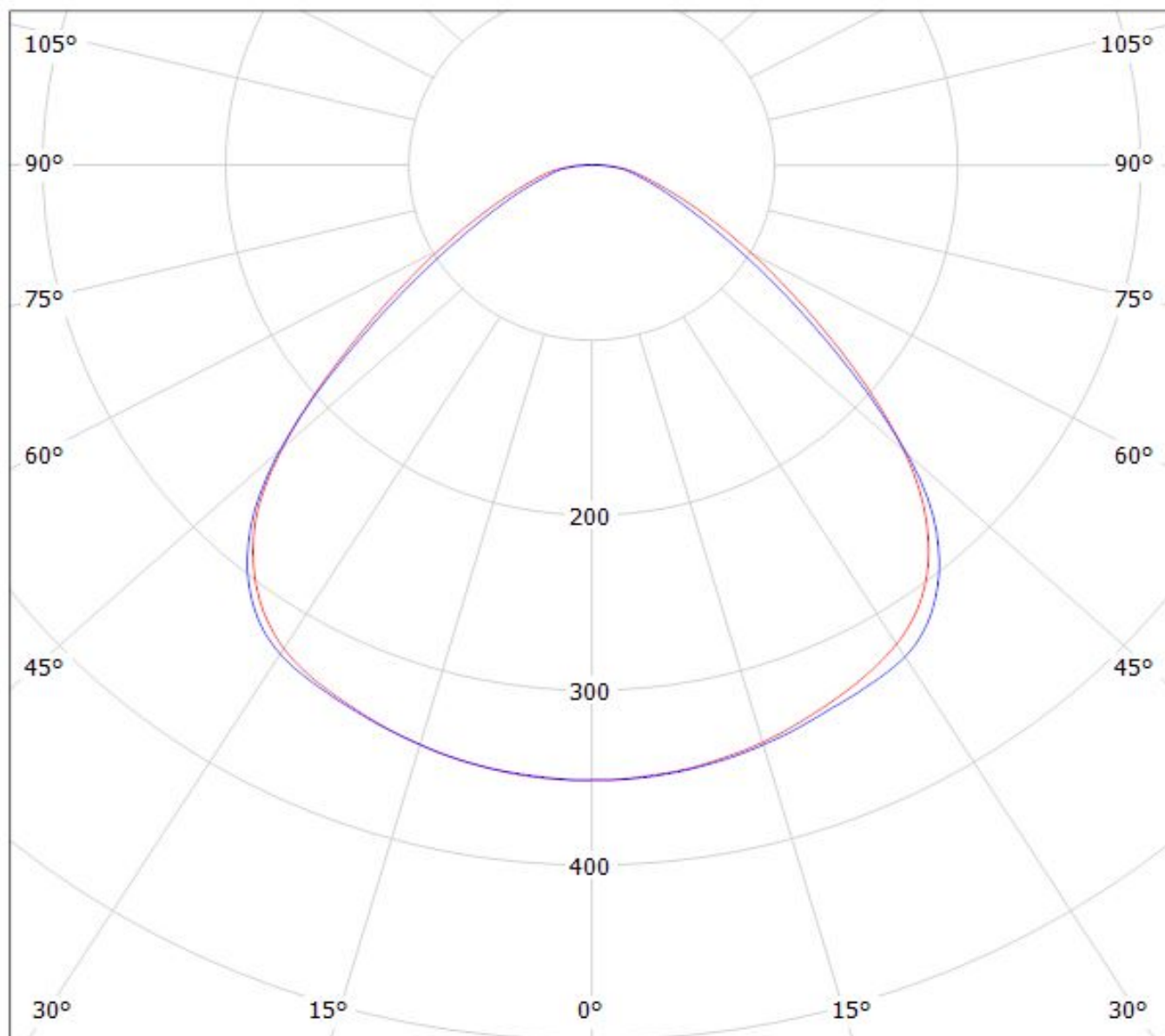

cd/klm

— C0 - C180

— C90 - C270

$\eta = 91\%$

Luminaire: Ledil FN15264_STELLA-HB-WWW_(Vero29_SE_Gen7)
Lamps: 1 x Vero29_SE_Gen7_1750.87lm@250mA_P=8.5765_I=0.25A

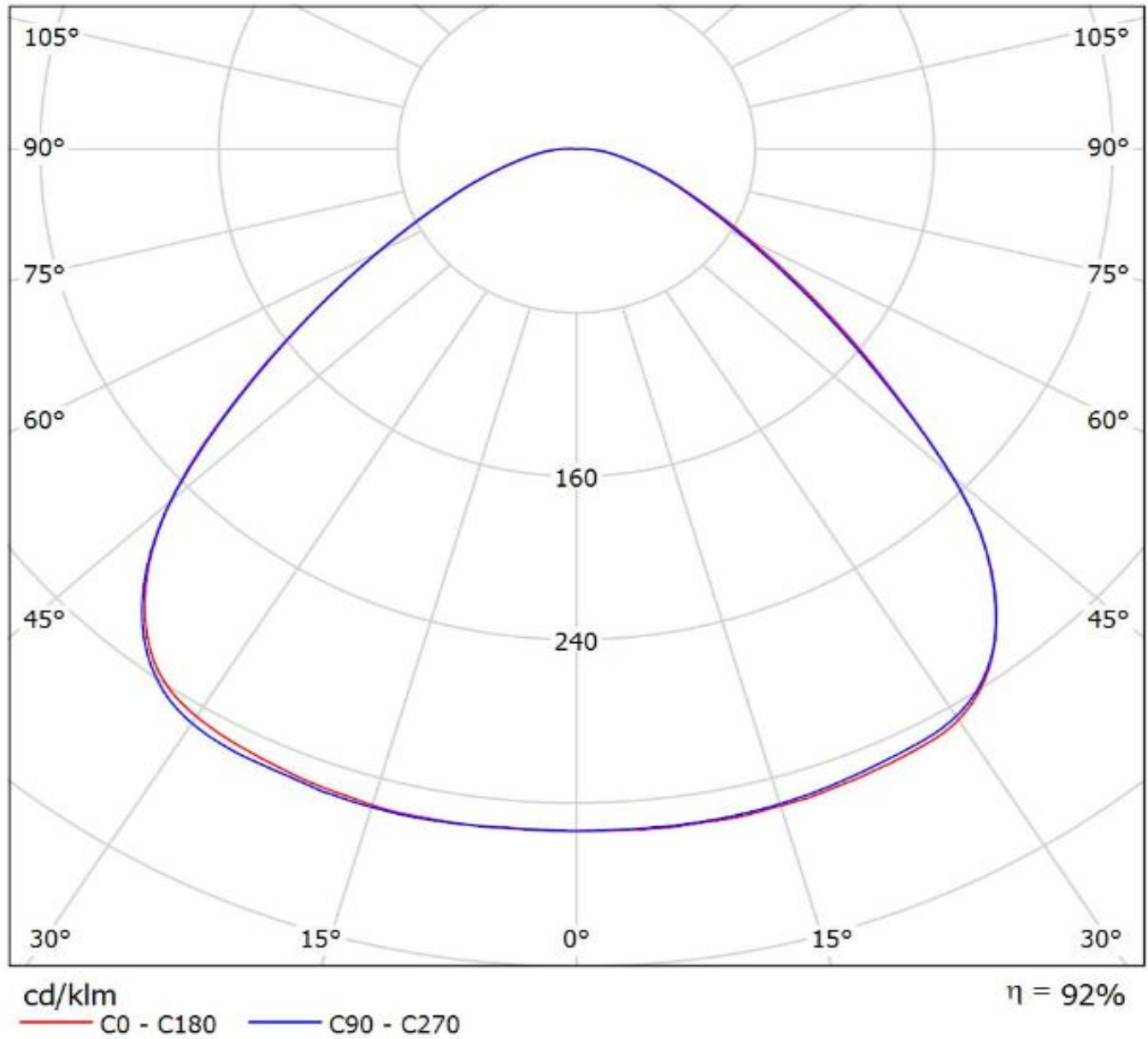

Luminaire: Ledil FN15264_STELLA-HB-WWW_(Vero_13_SE)
Lamps: 1 x Bridgelux_Vero_13_SE_(BXRC-30E2000-C-73-SE)
_1310.97lm@250mA_P=8.17575W_I=0.25A

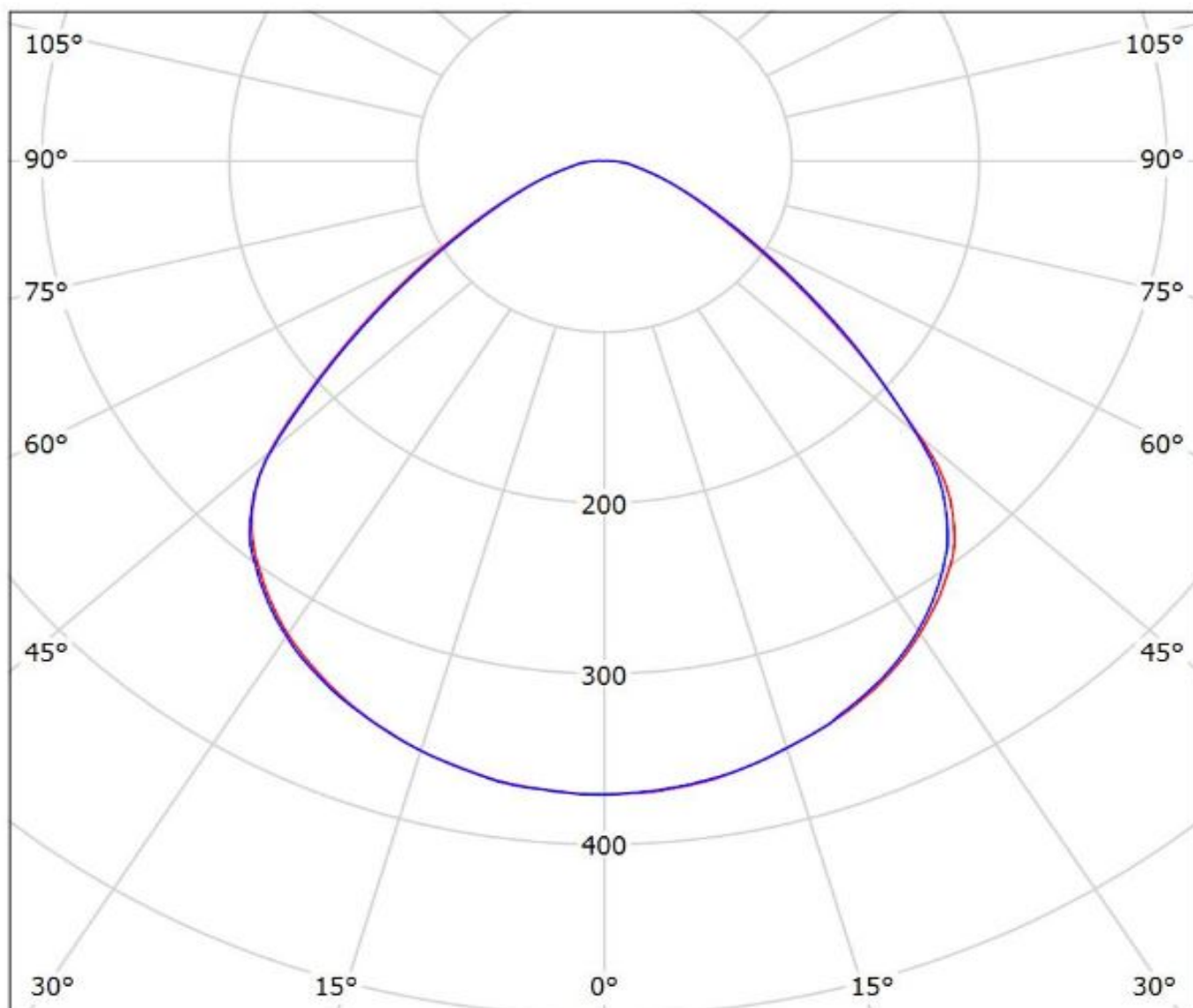

cd/klm
— C0 - C180 — C90 - C270

$\eta = 90\%$

Luminaire: LEDiL Oy FN15264_STELLA-HB-WWW_(VERO18_SE)
Lamps: 1 x Bridgelux_VERO18_SE_(BXRC-30E4000-C-73-SE)
_1335.46lm@250mA_P=7.9961W_I=0.25A

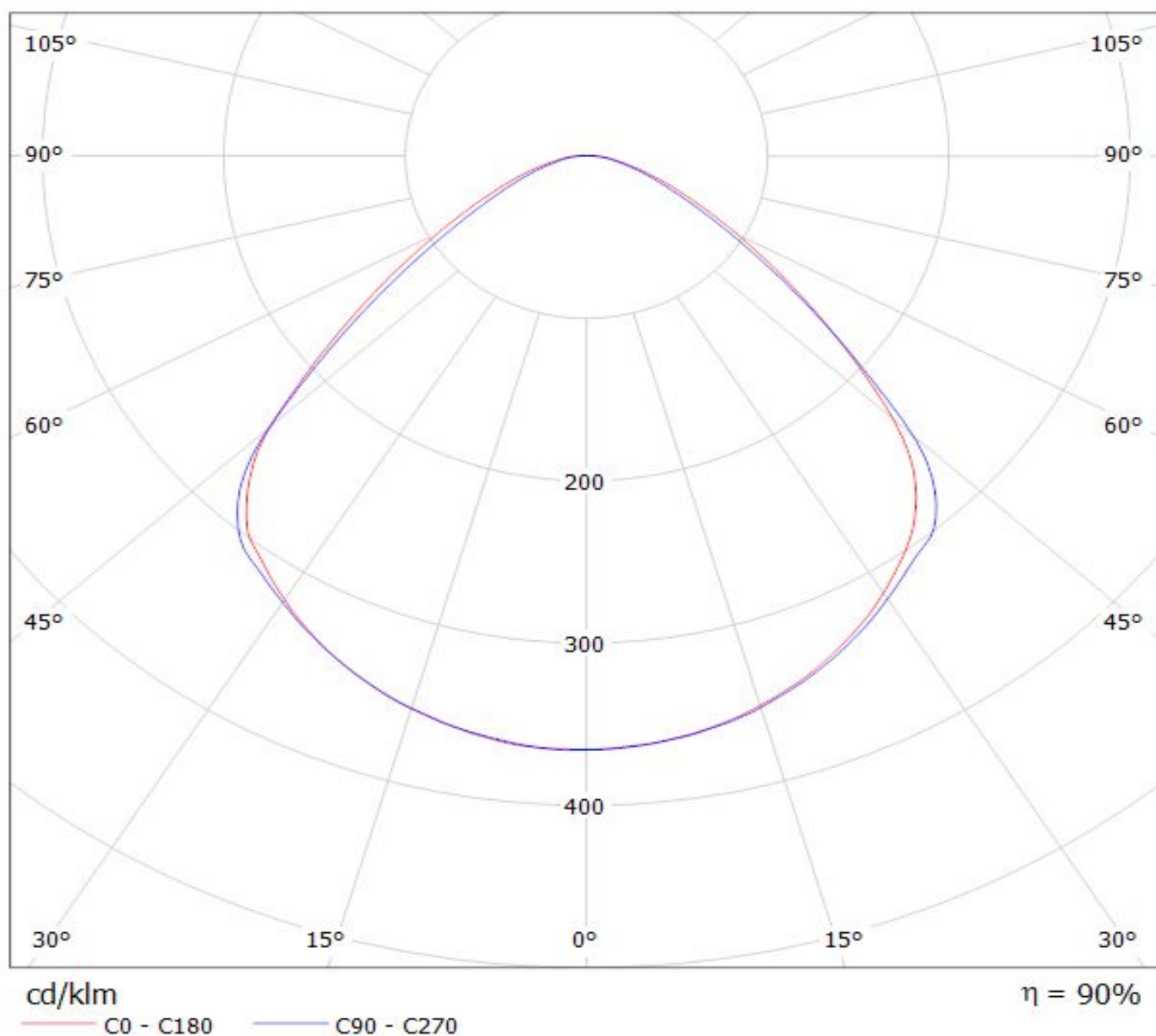

Luminaire: LEDiL Oy FN15264_STELLA-HB-WWW_(VERO18)

Lamps: 1 x Bridgelux_VERO18_(BRXE-30E4000-F-23)_CCT=3000K_1014.16lm@250mA_P=6.79456W_I=0.25A

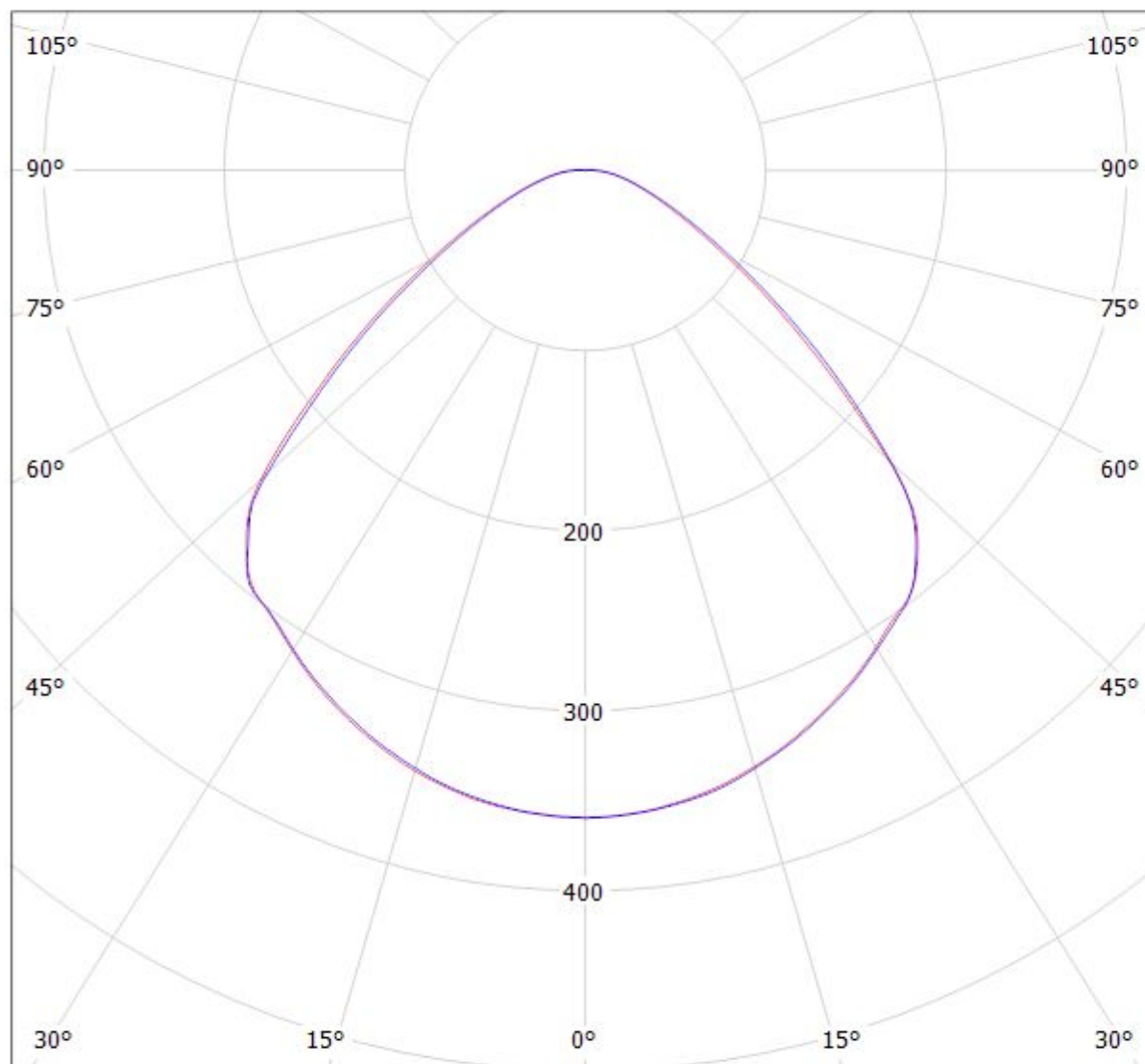

cd/klm

— C0 - C180 — C90 - C270

$\eta = 89\%$

Luminaire: Ledil Oy FN15264_STELLA-HB-WWW+_Bender&Wirth - LED holder 434 Typ Z1_BRIDGELUX_V10_Gen7
Lamps: 1 x BRIDGELUX V10 Gen7

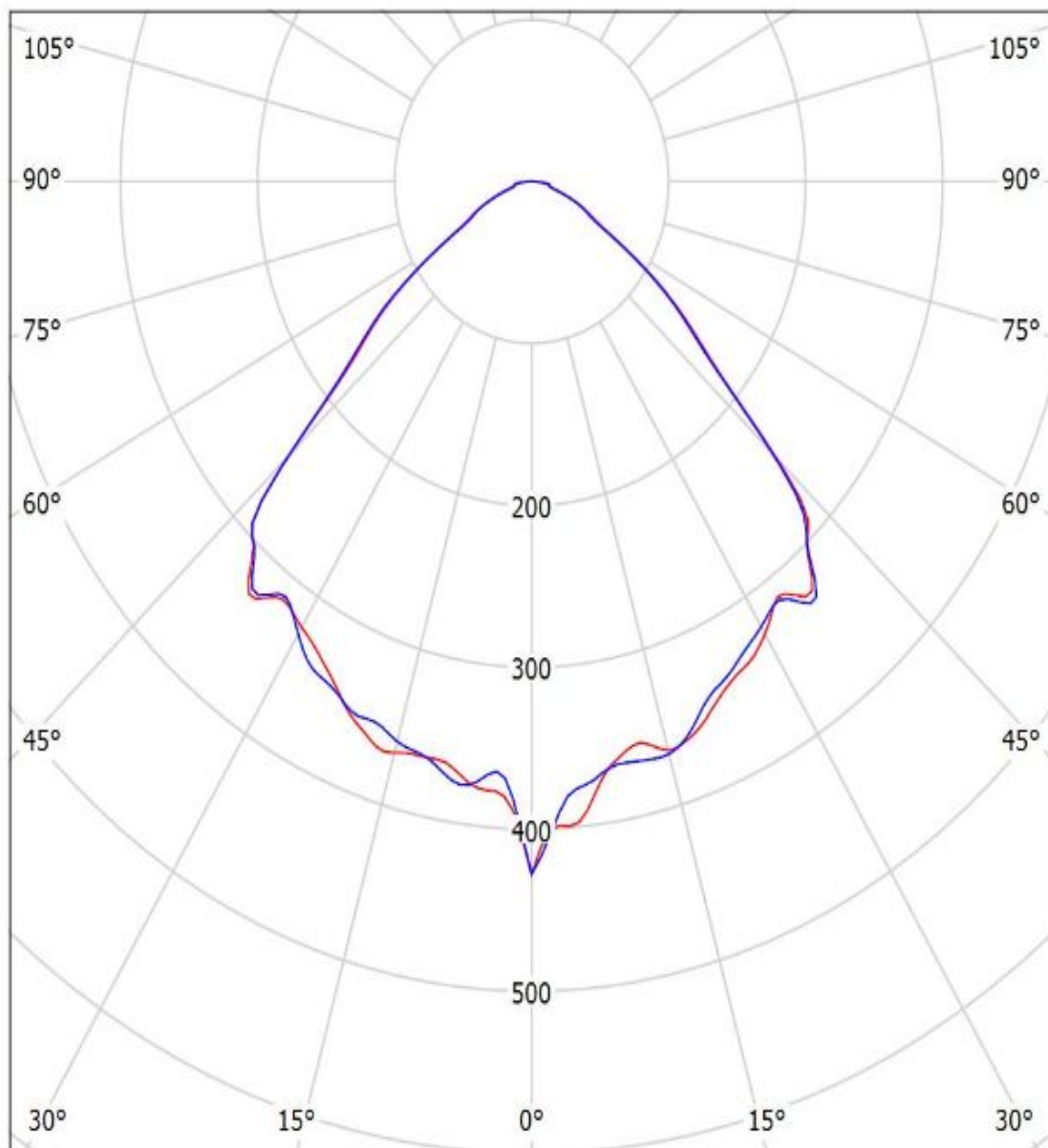

cd/klm

— C0 - C180 — C90 - C270

$\eta = 88\%$

Luminaire: Ledil Oy FN15264_STELLA-HB-WWW_Bridgelux_V22_Gen7_SIMULATED
Lamps: 1 x Bridgelux V22 Gen7

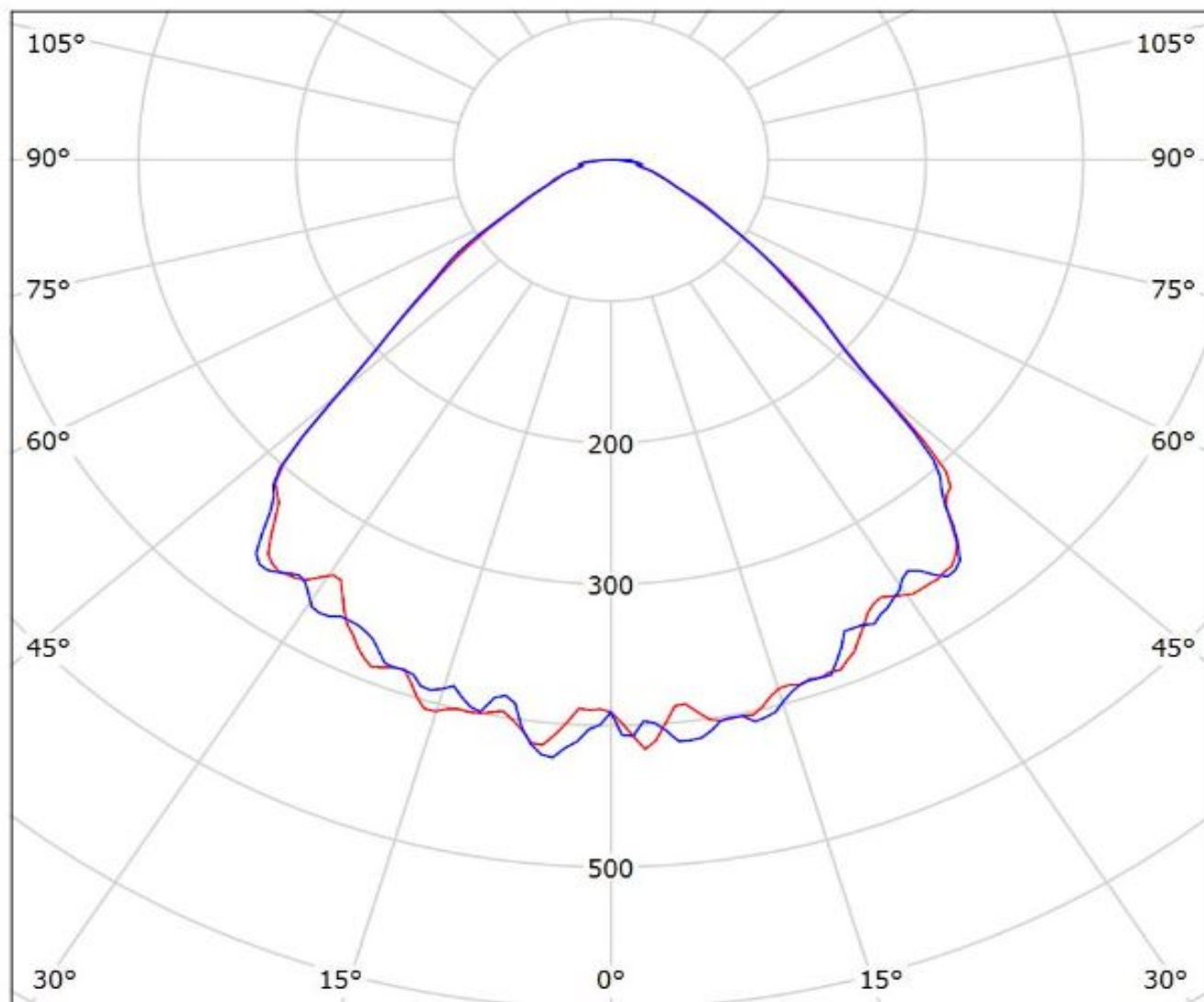

cd/klm
— C0 - C180 — C90 - C270

$\eta = 94\%$

Luminaire: Ledil Oy FN15264_STELLA-HB-WWW_Bridgelux_V22_Gen7_SIMULATED
Lamps: 1 x Bridgelux V22 Gen7

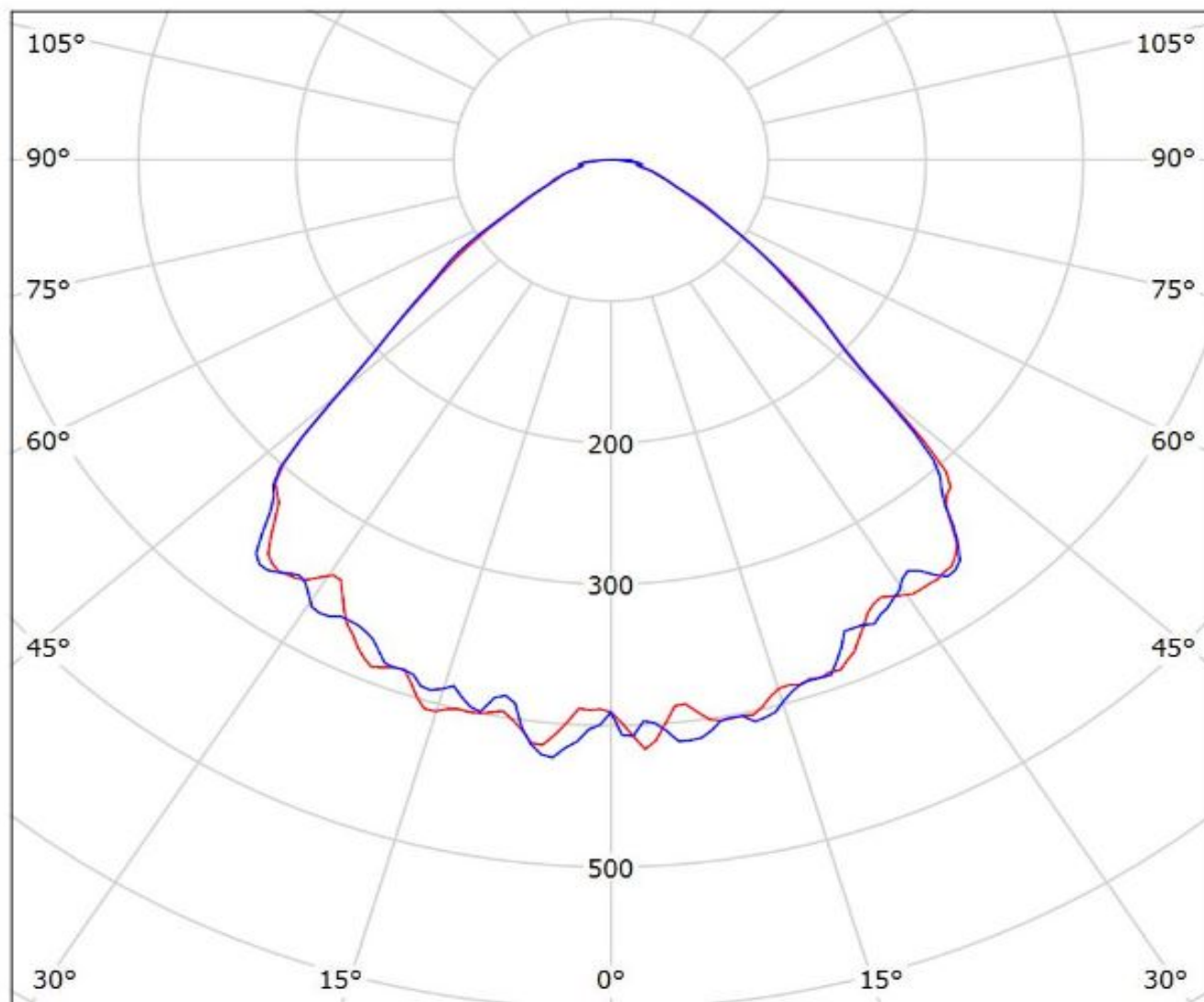

cd/klm
— C0 - C180 — C90 - C270

η = 94%

Luminaire: Ledil Oy FN15264_STELLA-HB-WWW+_BJB_47_319_2350_BRIDGELUX_V18_Gen7_SIMULATED
Lamps: 1 x BRIDGELUX V18 Gen7

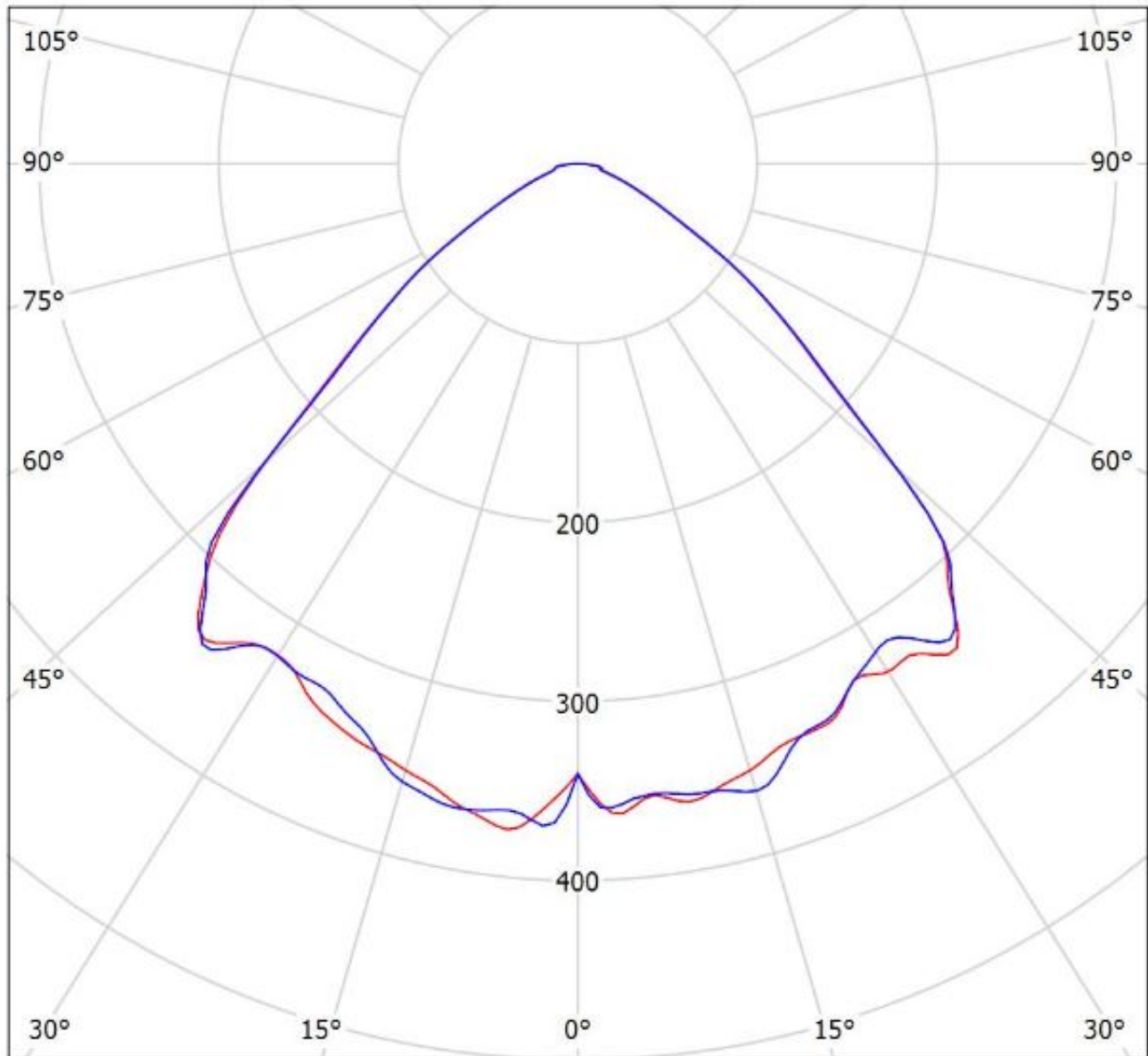

cd/klm

— C0 - C180 — C90 - C270

$\eta = 87\%$

Luminaire: LEDiL Oy FN15264_STELLA-HB-WWW_(CLL020)

Lamps: 1 x Citizen_CLL020_(-1203A1)_626.474lm@180mA_CCT=3215K_P=6.63588W_I=0.18A

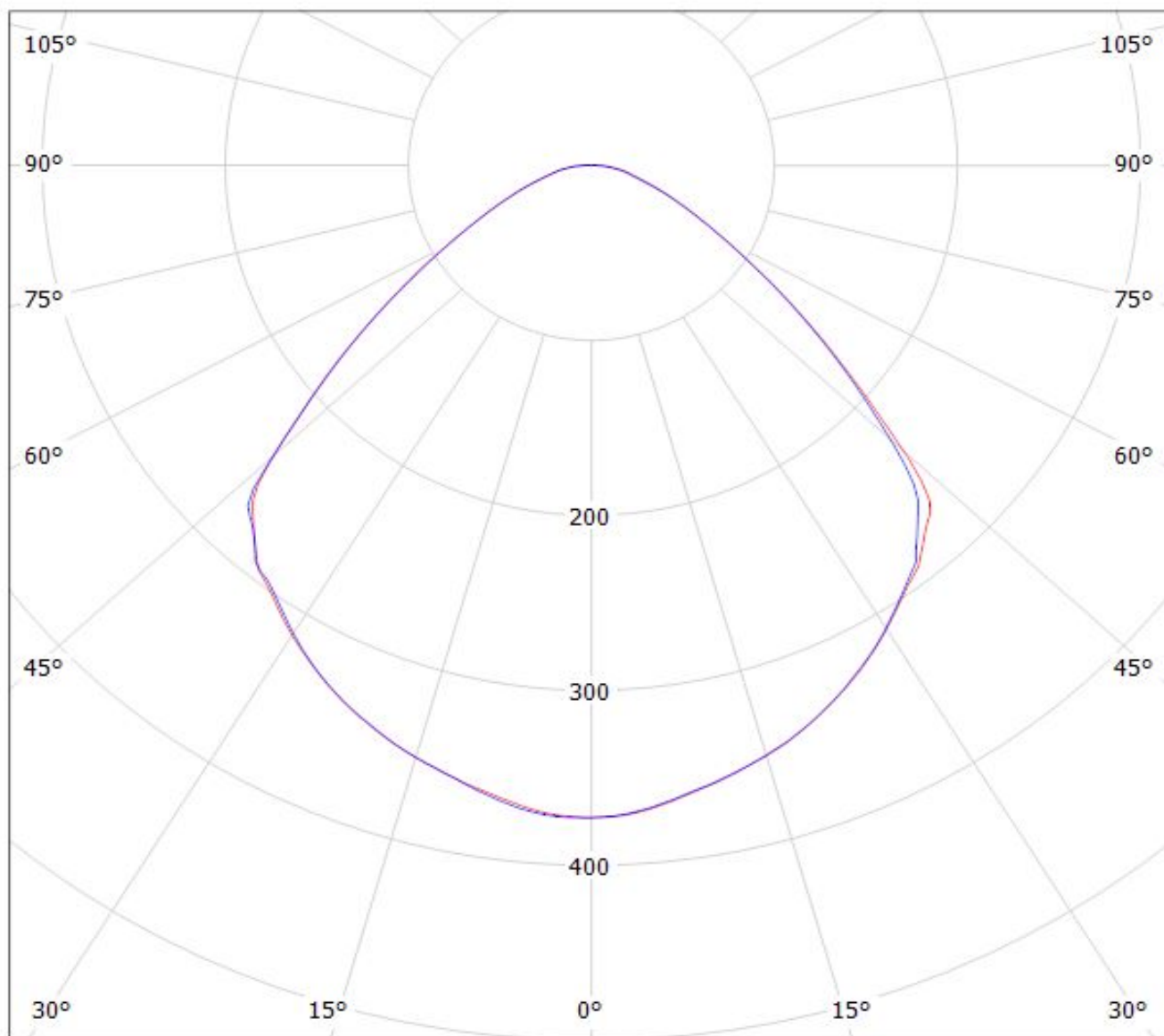

cd/klm

— C0 - C180

— C90 - C270

$\eta = 88\%$

Luminaire: LEDiL Oy FN15264_STELLA-HB-WWW_(CLU046)

Lamps: 1 x Citizen_CLU046_(-1212C1-303M2G2)_1373.06lm@250mA_CCT3000K_P=8.08253W_I=0.25A

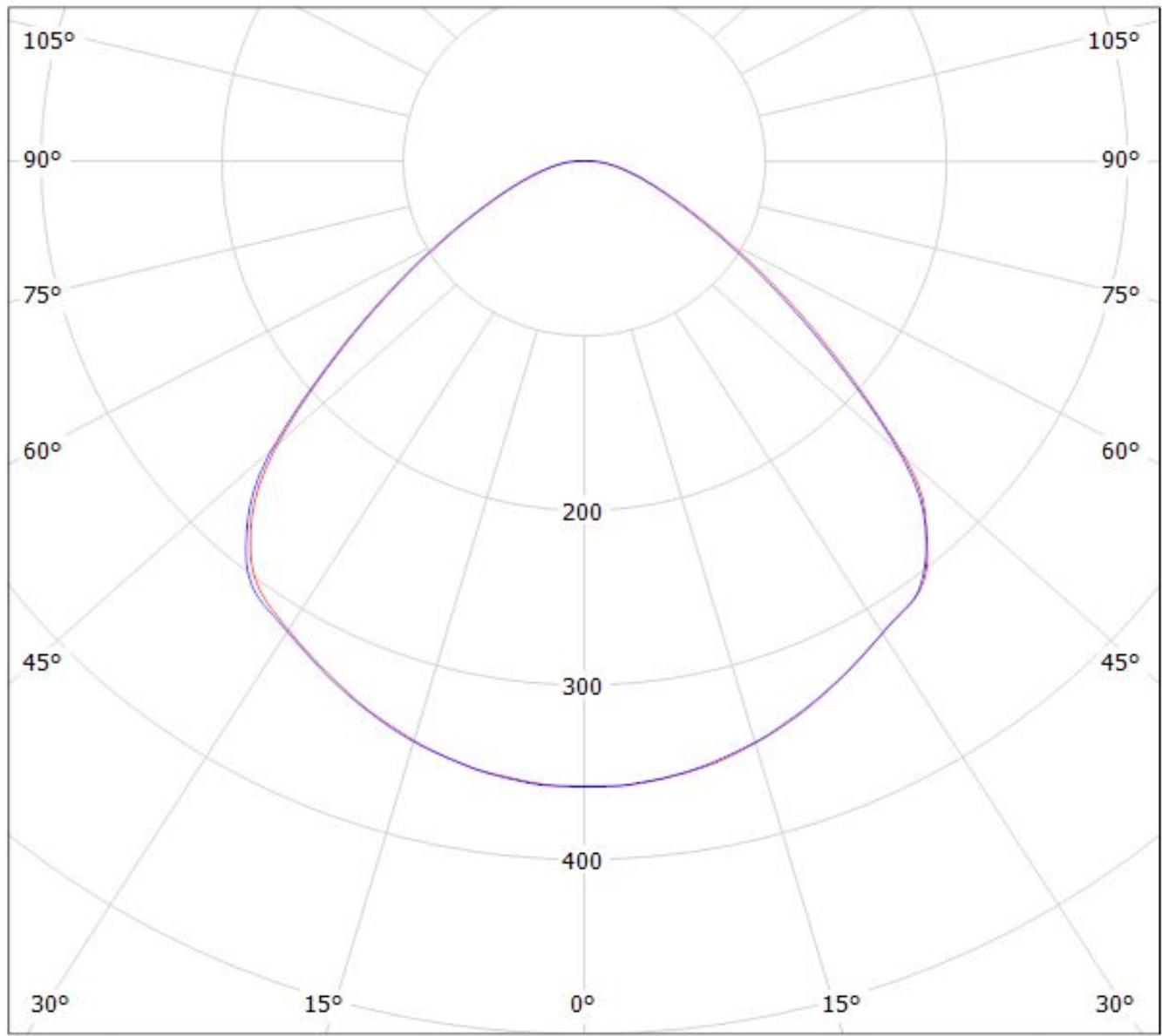

cd/klm

— C0 - C180

— C90 - C270

$\eta = 89\%$

Luminaire: Ledil Oy FN15264_STELLA-HB-WWW_CLU058_SIMULATED
Lamps: 1 x Citizen CLU058 (3618C4)

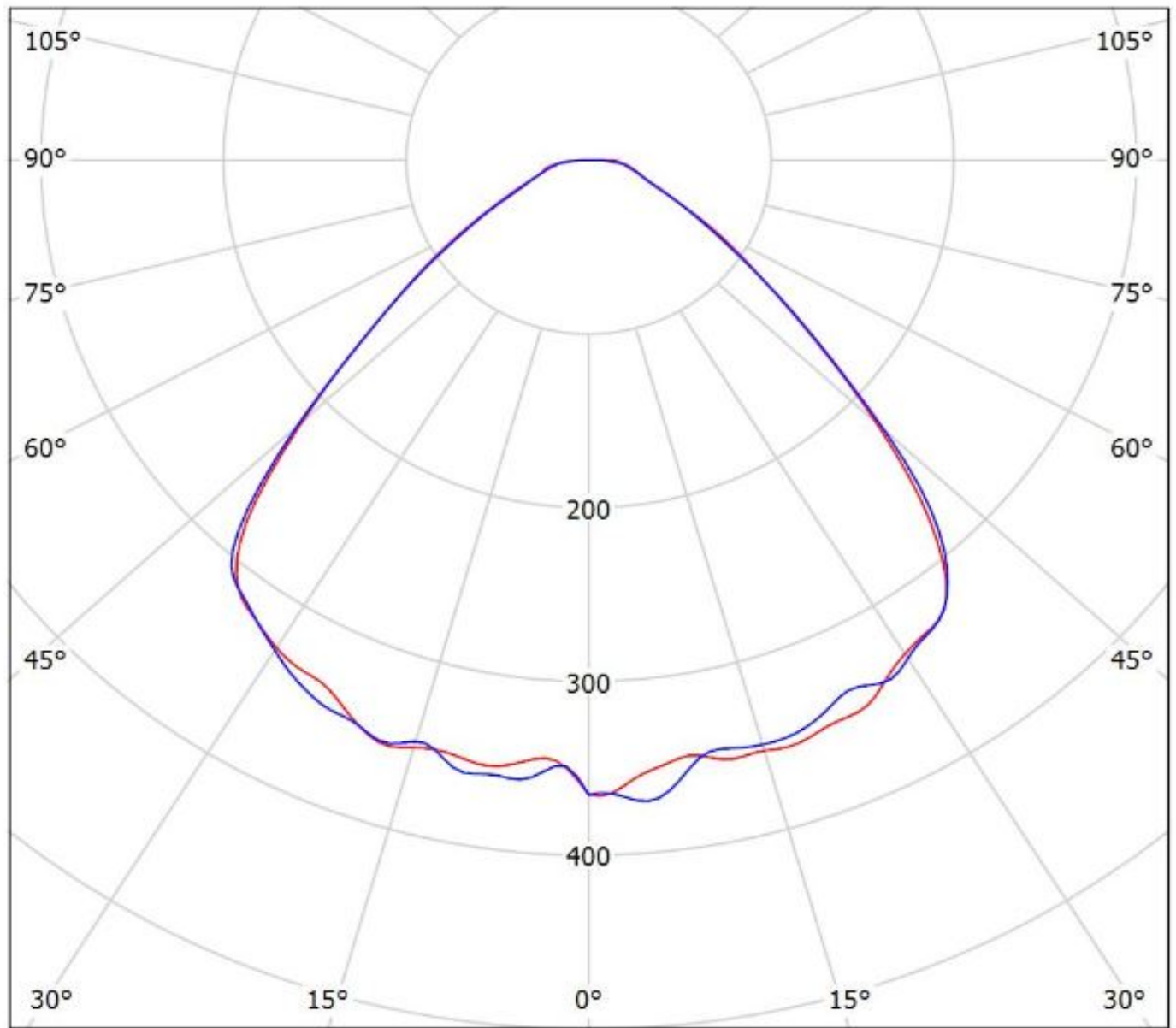

cd/klm

— C0 - C180 — C90 - C270

$\eta = 87\%$

Luminaire: LEDiL Oy FN15264_STELLA-HB-WWW_(CXB3590)

Lamps: 1 x Cree_CXB3590_(CXB2590-40G-C0-N0H-0001)_1518.77lm@250mA_P=7.90792W_I=0.250A

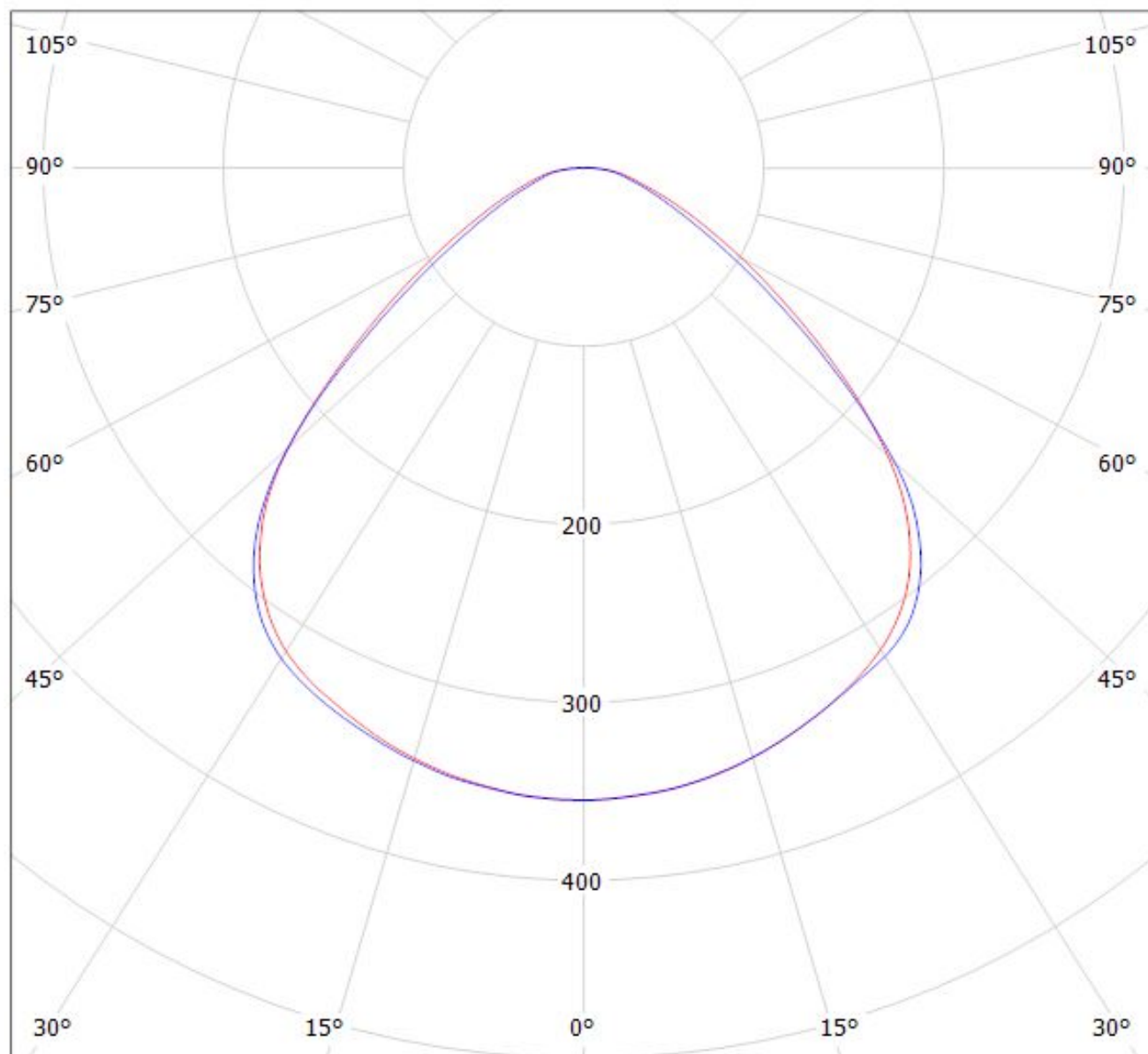

cd/klm

— C0 - C180

— C90 - C270

$\eta = 90\%$

Luminaire: Ledil Oy FN15379_STELLA-VSM_(Luxeon_CoB_1216)_(431_Typ_Z1)_SIMULATED
Lamps: 1 x Lumileds Luxeon CoB 1216 + Bender & Wirth 431 Type Z1

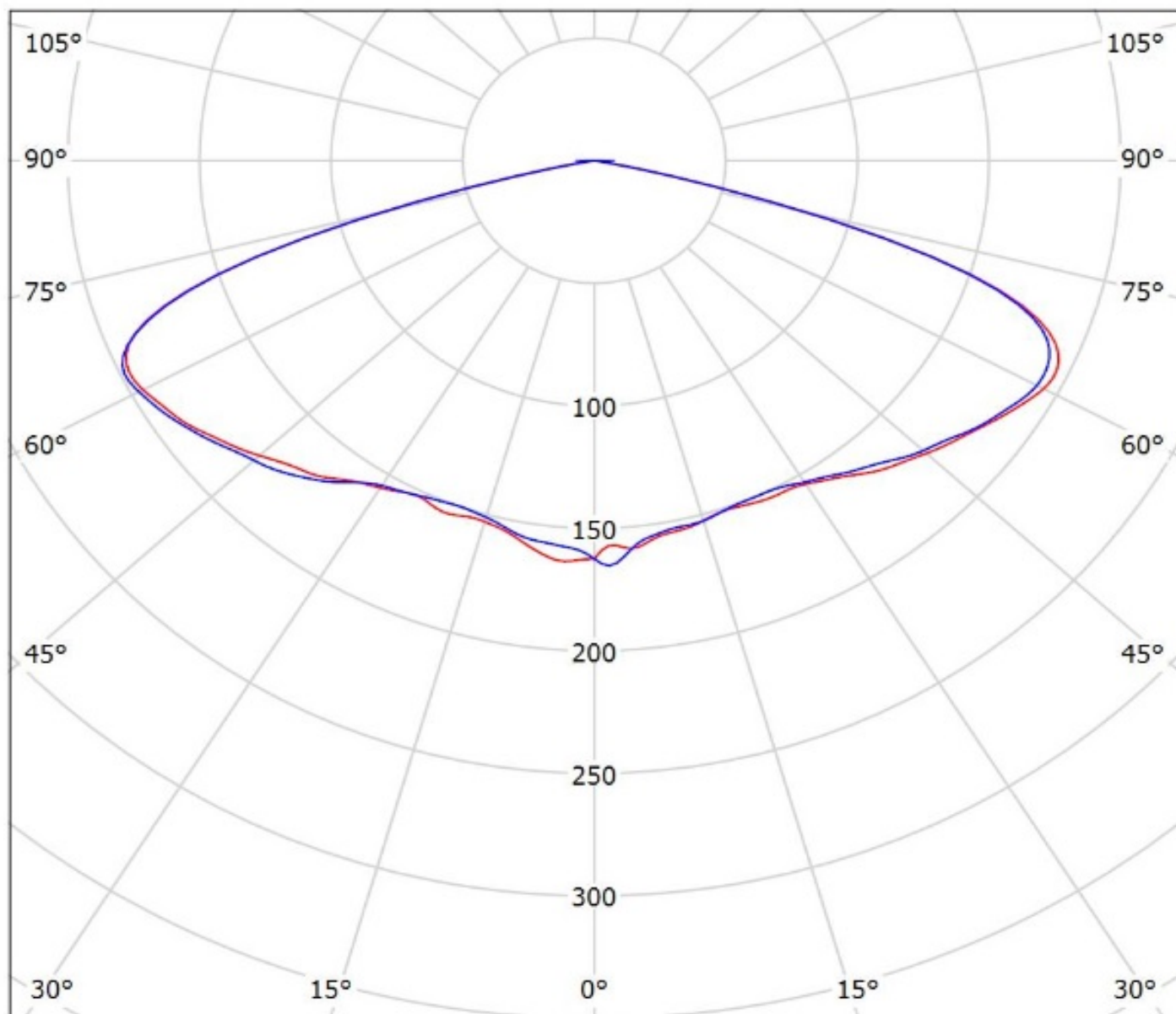

cd/klm

— C0 - C180 — C90 - C270

$\eta = 92\%$

Luminaire: LEDiL Oy FN15264_STELLA-HB-WWW_(SLM_1211_L19_G6)

Lamps: 1 x Philips_Fortimo_SLM_1211_L19_G6_Poke-In_1152.17lm@250mA_P=8.10051W_I=0.25A

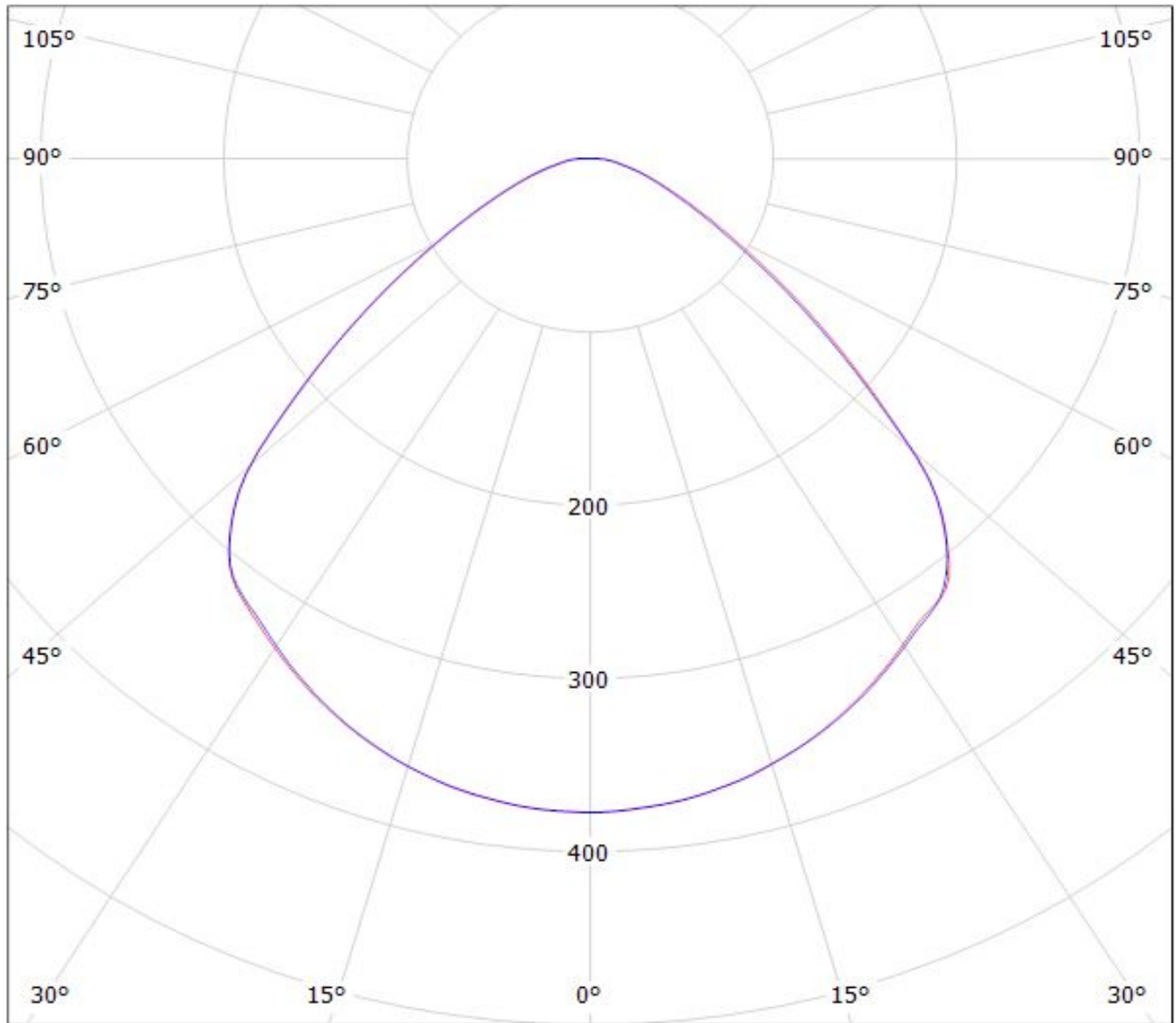

cd/klm

— C0 - C180

— C90 - C270

$\eta = 93\%$

Luminaire: Ledil FN15264_STELLA-HB-WWW_(MJT_180W_Les32,8)_+458TypL4
Lamps: 1 x Seoul_MJT_180W_Les32,8mm_(SAWx33GCA)_+458TypL4_3749.72lm@250mA_P=20.9727W_I=0.25A

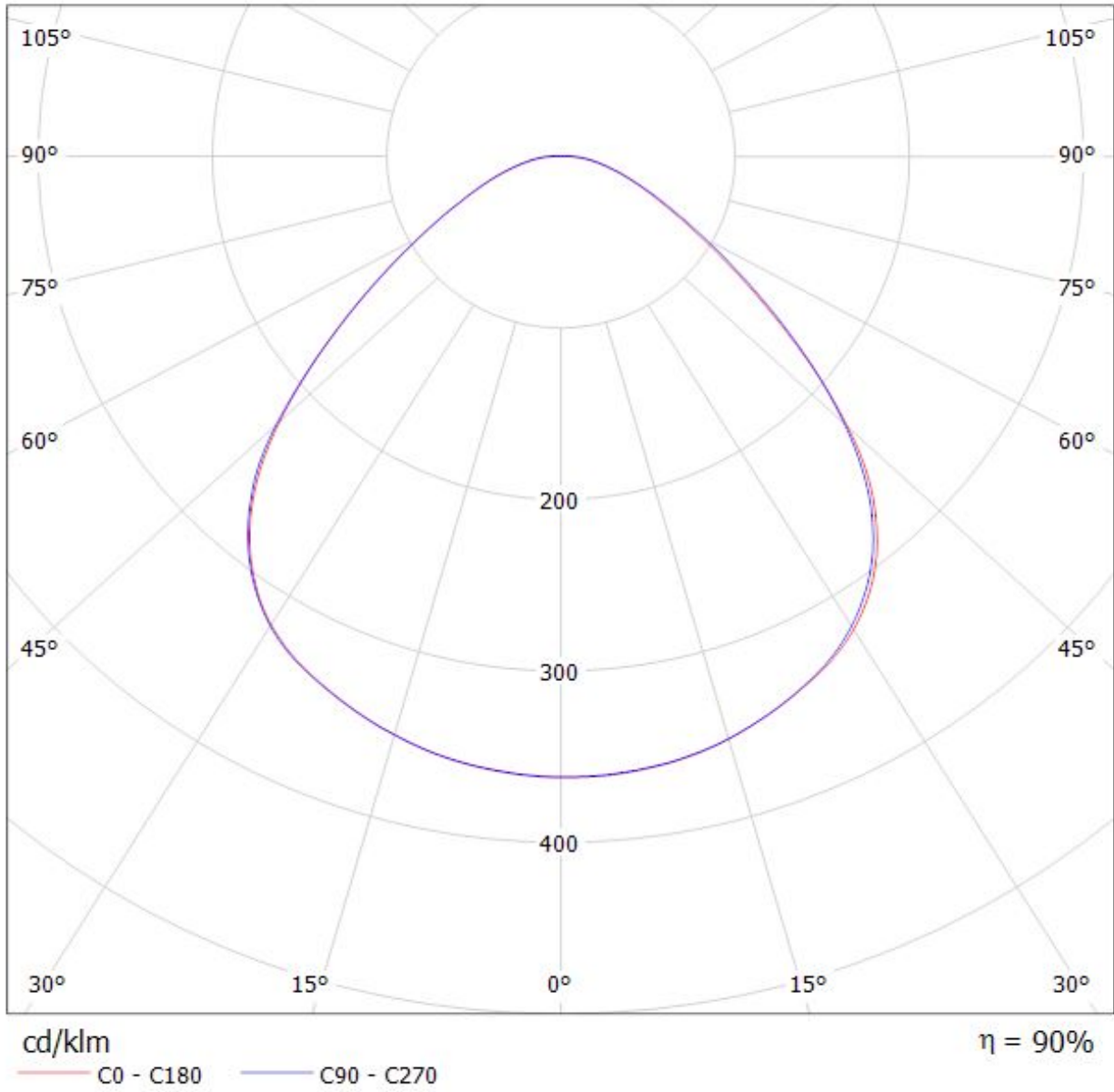

Luminaire: Ledil FN15264_STELLA-HB-WWW_(MJT_80W_Les22)_+Ideal_50-2204CT

Lamps: 1 x Seoul_MJT_80W_Les22mm_(SAWx22AAA)_+Ideal_50-2204CT_2497.65lm@250mA_P=13.3118W_I=0.25A

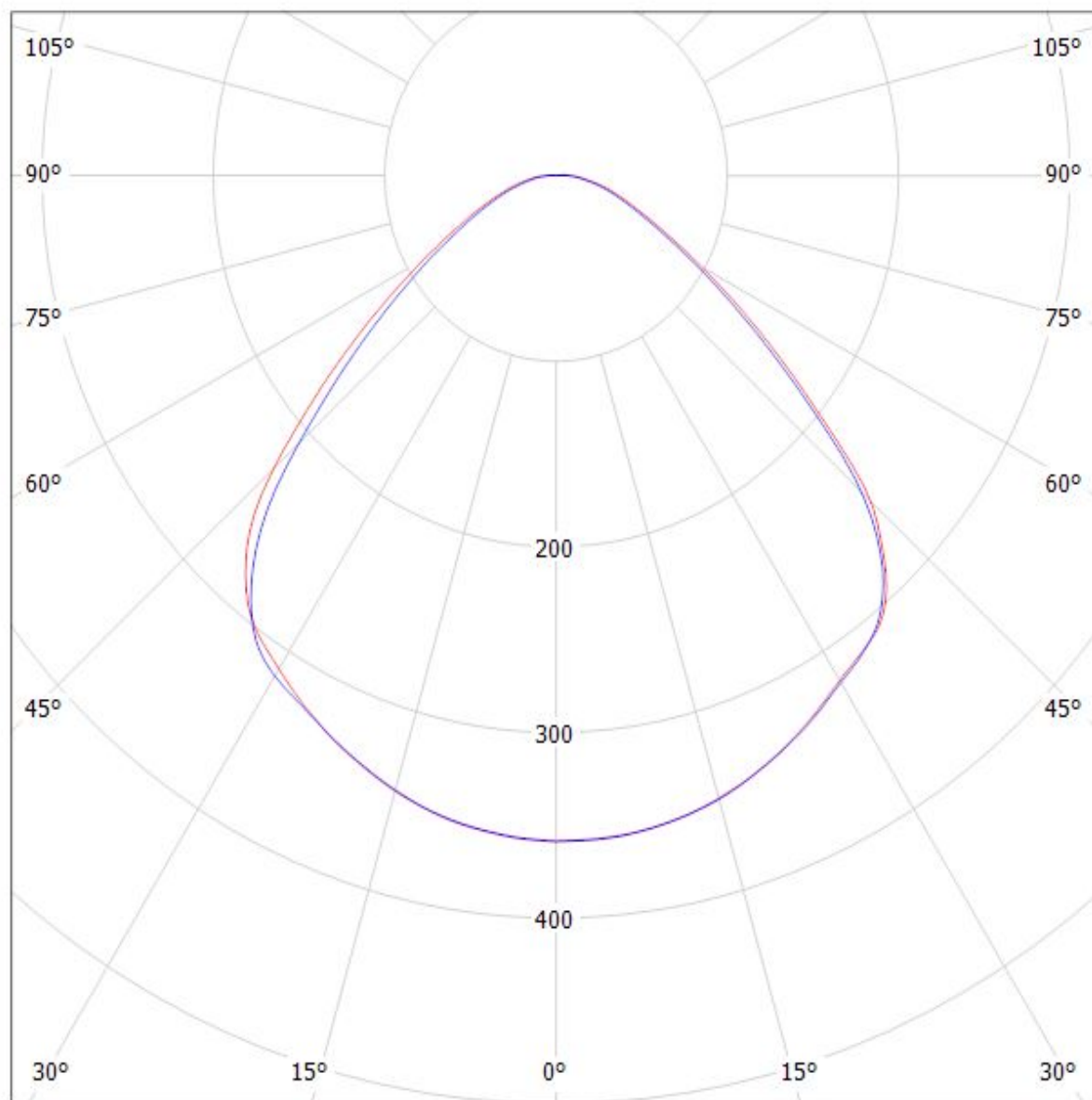

cd/klm

— C0 - C180

— C90 - C270

$\eta = 89\%$

Luminaire: Ledil FN15264_STELLA-HB-WWW_(MJT_80W_Les22)_+431TypZ1

Lamps: 1 x Seoul_MJT_80W_Les22mm_(SAWx22AAA)_+431TypZ1_2501.46lm@250mA_P=13.317W_I=0.25A

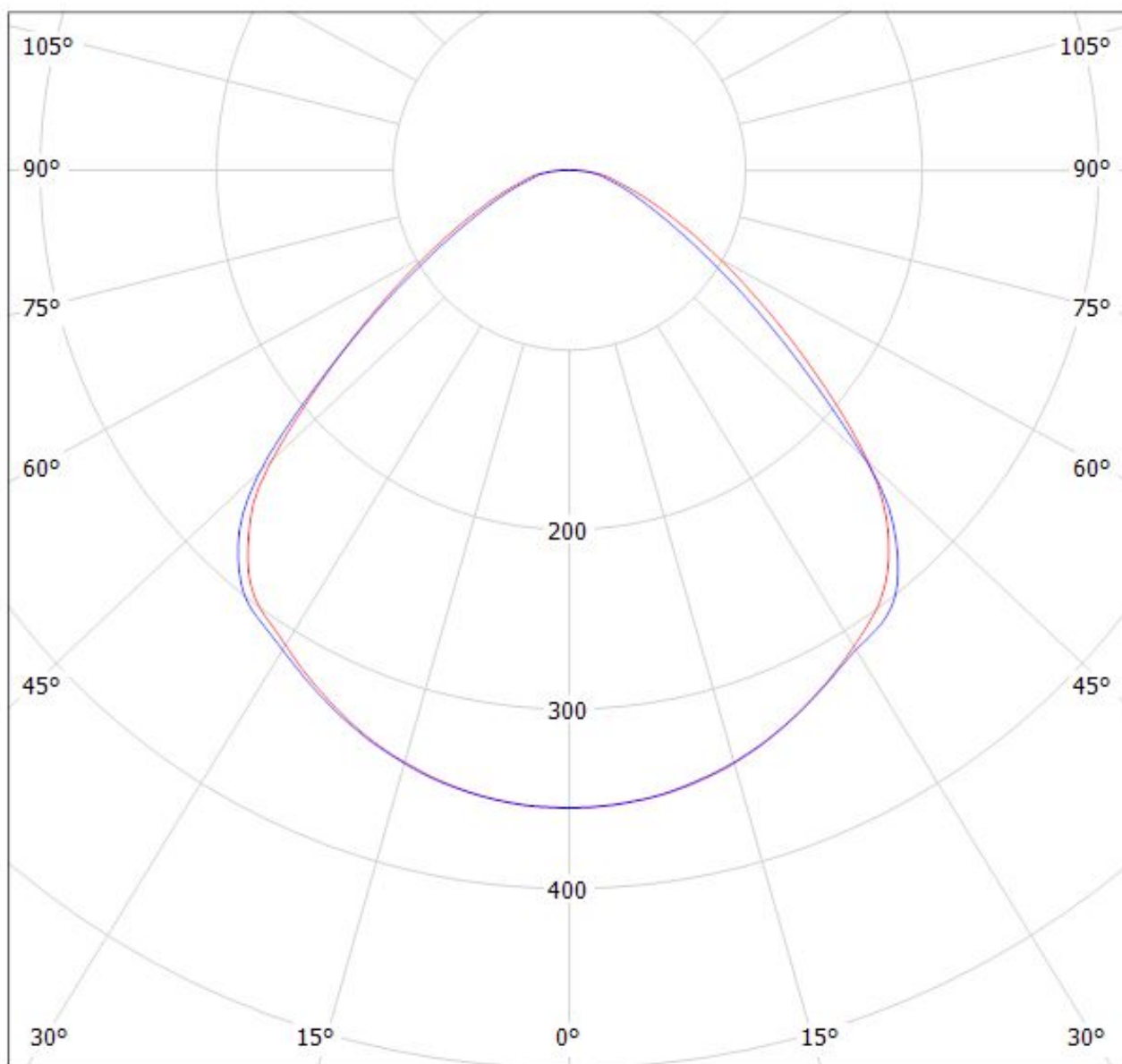

cd/klm

— C0 - C180 — C90 - C270

$\eta = 89\%$

Luminaire: Ledil FN15264_STELLA-HB-WWW_(MJT_30W_Les14,5)_+433_Typ_Z1

Lamps: 1 x Seoul_MJT_30W_Les14,5mm_(SAWx1566A)_433_Typ_Z1_1343.97lm@250mA_P=8.2295W_I=0.25A

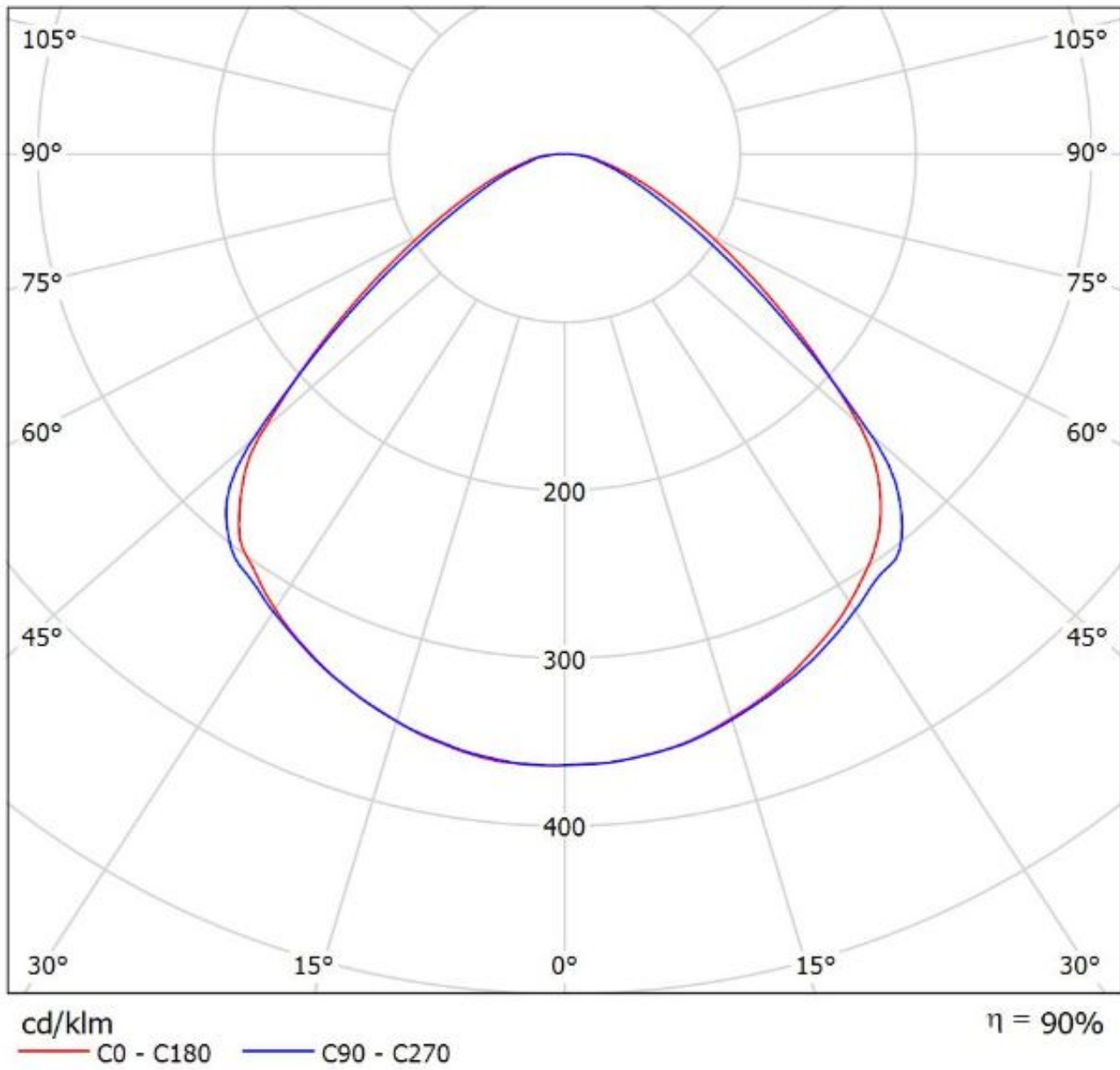

Luminaire: Ledil FN15264_STELLA-HB-WWW_(MJT_30W_Les14,5)

Lamps: 1 x Seoul_MJT_30W_Les14,5mm_(SAWx1566A)_1353.32lm@250mA_P=8.20525W_I=0.25A

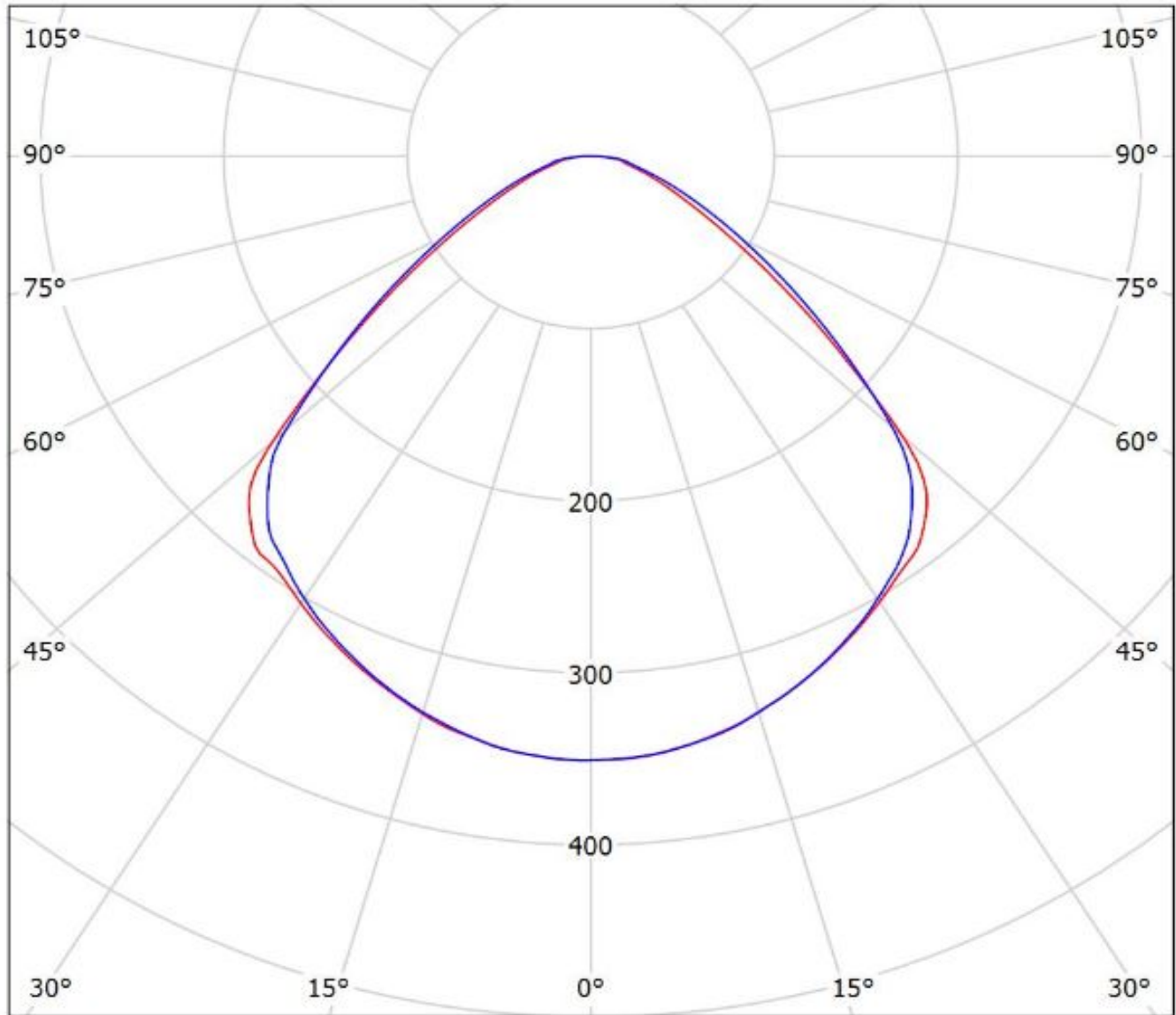

cd/klm

— C0 - C180 — C90 - C270

$\eta = 87\%$

NOTE: The typical divergence will be changed by different color, chip size and chip position tolerance. The typical total divergence is the full angle measured where the luminous intensity is half of the peak value.

GENERAL INFORMATION

- Product series especially designed & optimized for series of LEDs.
- Special care taken to make light distribution as uniform as possible.

Note! Due to use of high power COB's with this product, special attention to proper thermal design is highly recommended. LEDiL has no liability for direct, indirect or consecutive damages arising from the LEDiL products being used outside of the recommended temperature range.