



SiGe HBT GAIN BLOCK MMIC AMPLIFIER, DC - 5 GHz

Typical Applications

The HMC481MP86 / HMC481MP86E is an ideal RF/IF gain block & LO or PA driver for:

- Cellular / PCS / 3G
- Fixed Wireless & WLAN
- CATV, Cable Modem & DBS
- Microwave Radio & Test Equipment

Functional Diagram

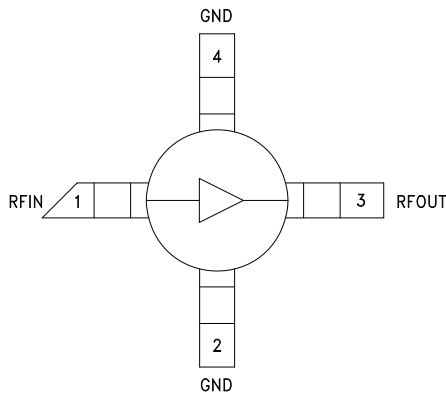

Features

- P1dB Output Power: +20 dBm
- Gain: 20 dB
- Output IP3: +33 dBm
- Cascadable 50 Ohm I/Os
- Single Supply: +6V to +12V
- Included in the HMC-DK001 Designer's Kit

General Description

The HMC481MP86 & HMC481MP86E are SiGe Heterojunction Bipolar Transistor (HBT) Gain Block MMIC SMT amplifiers covering DC to 5 GHz. This Micro-P packaged amplifier can be used as a cascadable 50 Ohm RF/IF gain stage as well as a LO or PA driver with up to +21 dBm output power. The HMC481MP86(E) offers 20 dB of gain with a +33 dBm output IP3 at 850 MHz while requiring only 74 mA from a single positive supply. The Darlington feedback pair used results in reduced sensitivity to normal process variations and excellent gain stability over temperature while requiring a minimal number of external bias components.

Electrical Specifications, $V_s = 8.0\text{ V}$, $R_{bias} = 39\text{ Ohm}$, $T_A = +25^\circ\text{ C}$

Parameter	Min.	Typ.	Max.	Units	
Gain	DC - 1.0 GHz	18.5	20.0	dB	
	1.0 - 2.0 GHz	15.5	17.0	dB	
	2.0 - 3.0 GHz	12.5	14.0	dB	
	3.0 - 4.0 GHz	10.5	12.0	dB	
	4.0 - 5.0 GHz	9.0	10.5	dB	
Gain Variation Over Temperature	DC - 5 GHz		0.008	0.012	dB/ °C
Input Return Loss	DC - 1.0 GHz		13	dB	
	1.0 - 5.0 GHz		17	dB	
Output Return Loss	DC - 1.0 GHz		20	dB	
	1.0 - 4.0 GHz		25	dB	
	4.0 - 5.0 GHz		15	dB	
Reverse Isolation	DC - 5 GHz		18	dB	
Output Power for 1 dB Compression (P1dB)	0.5 - 1.0 GHz	16	20	dBm	
	1.0 - 2.0 GHz	15	18	dBm	
	2.0 - 3.0 GHz	14	17	dBm	
	3.0 - 4.0 GHz	12	15	dBm	
	4.0 - 5.0 GHz	9	12	dBm	
Output Third Order Intercept (IP3) (Pout= 0 dBm per tone, 1 MHz spacing)	0.5 - 2.0 GHz		33	dBm	
	2.0 - 3.0 GHz		31	dBm	
	3.0 - 4.0 GHz		29	dBm	
	4.0 - 5.0 GHz		26	dBm	
Noise Figure	DC - 2.0 GHz		3.5	dB	
	2.0 - 4.0 GHz		4.0	dB	
	4.0 - 5.0 GHz		4.5	dB	
Supply Current (Icq)		74	85	mA	

Note: Data taken with broadband bias tee on device output.

Information furnished by Analog Devices is believed to be accurate and reliable. However, no responsibility is assumed by Analog Devices for its use, nor for any infringements of patents or other rights of third parties that may result from its use. Specifications subject to change without notice. No license is granted by implication or otherwise under any patent or patent rights of Analog Devices. Trademarks and registered trademarks are the property of their respective owners.

For price, delivery, and to place orders: Analog Devices, Inc., One Technology Way, P.O. Box 9106, Norwood, MA 02062-9106
Phone: 781-329-4700 • Order online at www.analog.com
Application Support: Phone: 1-800-ANALOG-D

HMC481MP86* PRODUCT PAGE QUICK LINKS

Last Content Update: 02/23/2017

COMPARABLE PARTS

View a parametric search of comparable parts.

EVALUATION KITS

- HMC481MP86 Evaluation Board

DOCUMENTATION

Data Sheet

- HMC481MP86: SiGe HBT Gain Block MMIC Amplifier, DC - 5 GHz Data Sheet

TOOLS AND SIMULATIONS

- HMC481MP86 S-Parameters

REFERENCE MATERIALS

Quality Documentation

- Package/Assembly Qualification Test Report: 3 Lead Plastic SOT89 Package (QTR: 10002 REV: 02)
- Package/Assembly Qualification Test Report: Plastic Encapsulated 4-LEAD MICRO-P (QTR: 05007 REV: 01)
- Semiconductor Qualification Test Report: SiGe HBT-A (QTR: 2013-00227)

DESIGN RESOURCES

- HMC481MP86 Material Declaration
- PCN-PDN Information
- Quality And Reliability
- Symbols and Footprints

DISCUSSIONS

View all HMC481MP86 EngineerZone Discussions.

SAMPLE AND BUY

Visit the product page to see pricing options.

TECHNICAL SUPPORT

Submit a technical question or find your regional support number.

DOCUMENT FEEDBACK

Submit feedback for this data sheet.



**SiGe HBT GAIN BLOCK
MMIC AMPLIFIER, DC - 5 GHz**

Broadband Gain & Return Loss

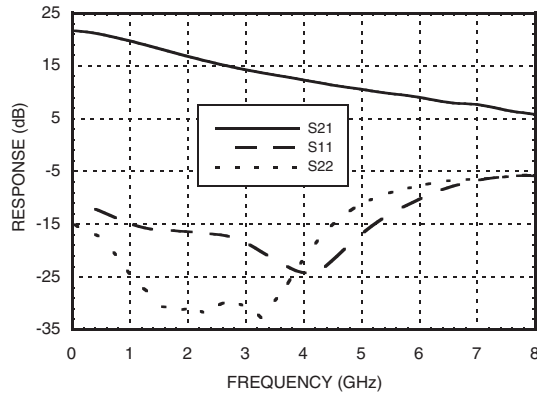

Gain vs. Temperature

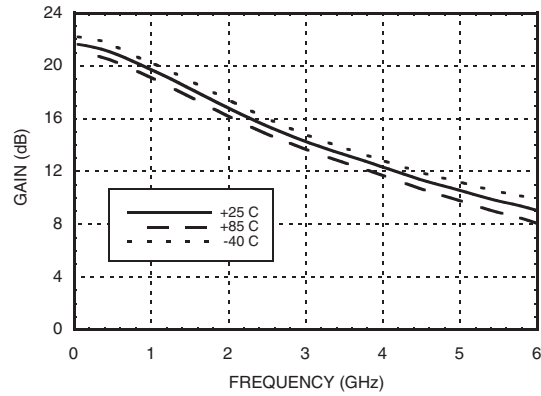

Input Return Loss vs. Temperature

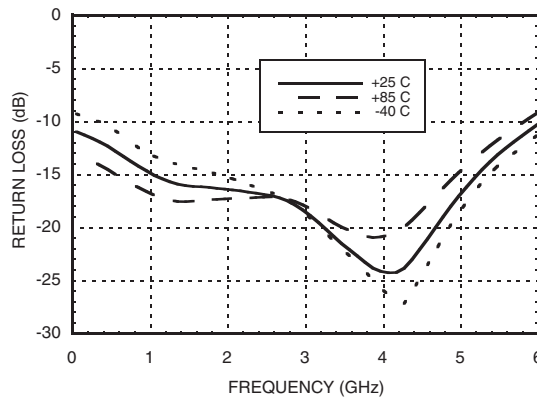

Output Return Loss vs. Temperature

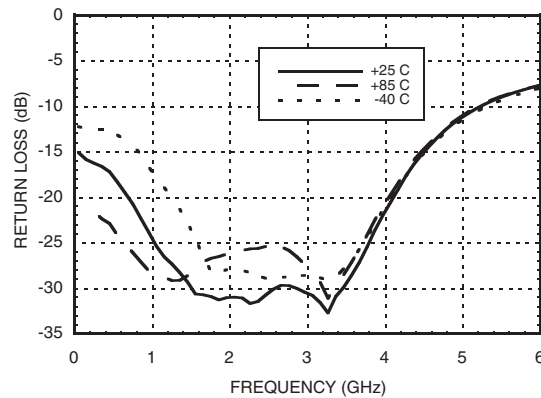

Reverse Isolation vs. Temperature

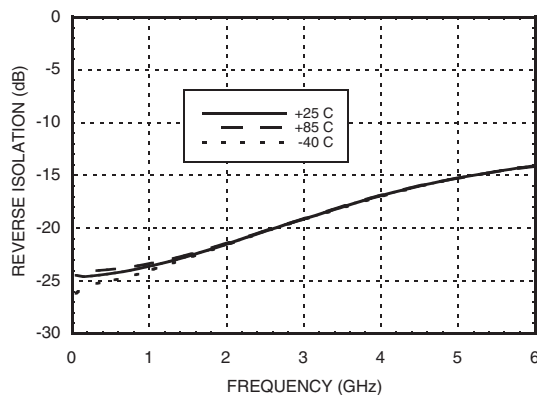

Noise Figure vs. Temperature

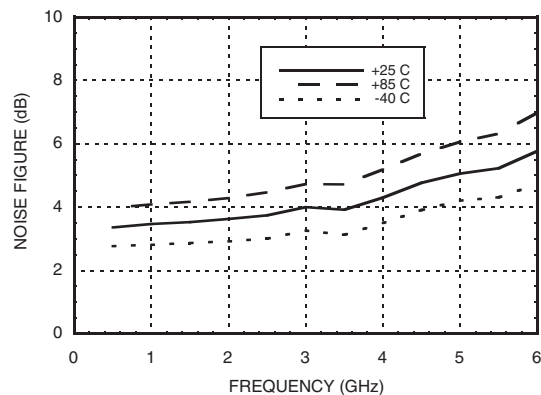

Information furnished by Analog Devices is believed to be accurate and reliable. However, no responsibility is assumed by Analog Devices for its use, nor for any infringements of patents or other rights of third parties that may result from its use. Specifications subject to change without notice. No license is granted by implication or otherwise under any patent or patent rights of Analog Devices. Trademarks and registered trademarks are the property of their respective owners.

For price, delivery, and to place orders: Analog Devices, Inc., One Technology Way, P.O. Box 9106, Norwood, MA 02062-9106 Phone: 781-329-4700 • Order online at www.analog.com Application Support: Phone: 1-800-ANALOG-D



**SiGe HBT GAIN BLOCK
MMIC AMPLIFIER, DC - 5 GHz**

8

AMPLIFIERS - DRIVER & GAIN BLOCK - SMT

P1dB vs. Temperature

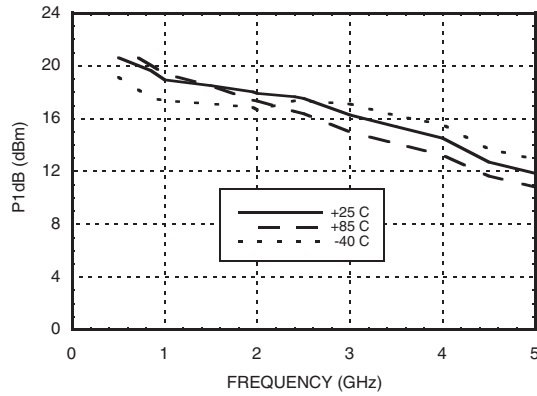

Psat vs. Temperature

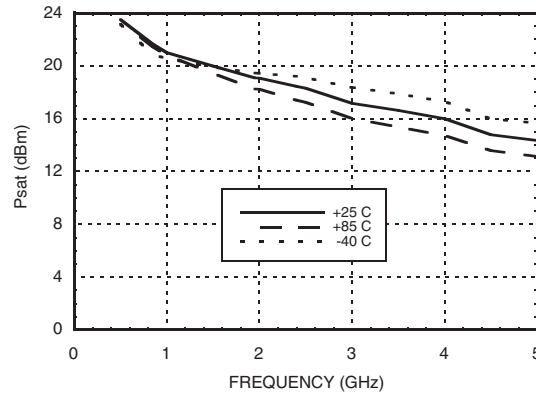

Output IP3 vs. Temperature

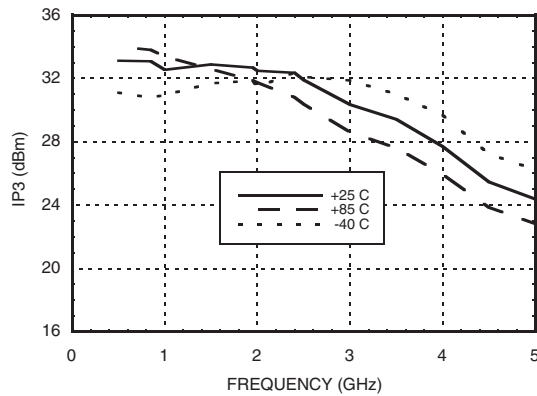

Gain, Power & Output IP3 vs. Supply Voltage for Constant Id= 74 mA @ 850 MHz

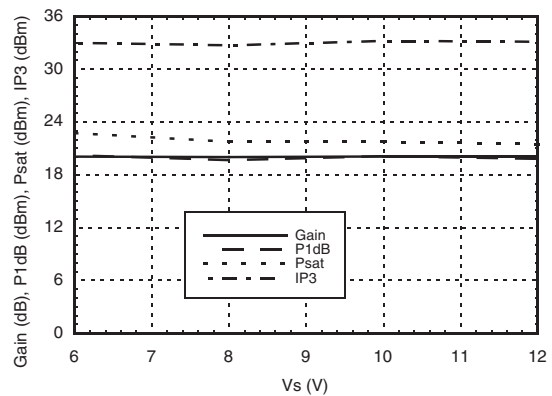

**Vcc vs. Icc Over Temperature for
Fixed Vs= 8V, RBIAS= 39 Ohms**

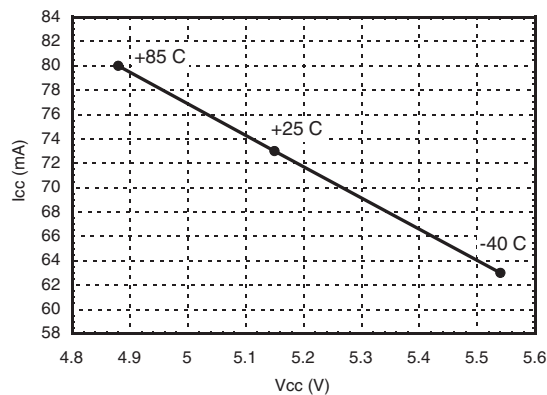

Information furnished by Analog Devices is believed to be accurate and reliable. However, no responsibility is assumed by Analog Devices for its use, nor for any infringements of patents or other rights of third parties that may result from its use. Specifications subject to change without notice. No license is granted by implication or otherwise under any patent or patent rights of Analog Devices. Trademarks and registered trademarks are the property of their respective owners.

For price, delivery, and to place orders: Analog Devices, Inc., One Technology Way, P.O. Box 9106, Norwood, MA 02062-9106 Phone: 781-329-4700 • Order online at www.analog.com Application Support: Phone: 1-800-ANALOG-D

Absolute Maximum Ratings

Collector Bias Voltage (Vcc)	+6 Vdc
Collector Bias Current (Icc)	100 mA
RF Input Power (RFIN)(Vcc = +5.15 Vdc)	+10 dBm
Junction Temperature	150 °C
Continuous P _{diss} (T = 85 °C) (derate 11.6 mW/°C above 85 °C)	0.753 W
Thermal Resistance (junction to lead)	86.3 °C/W
Storage Temperature	-65 to +150 °C
Operating Temperature	-40 to +85 °C
ESD Sensitivity (HBM)	Class 1A

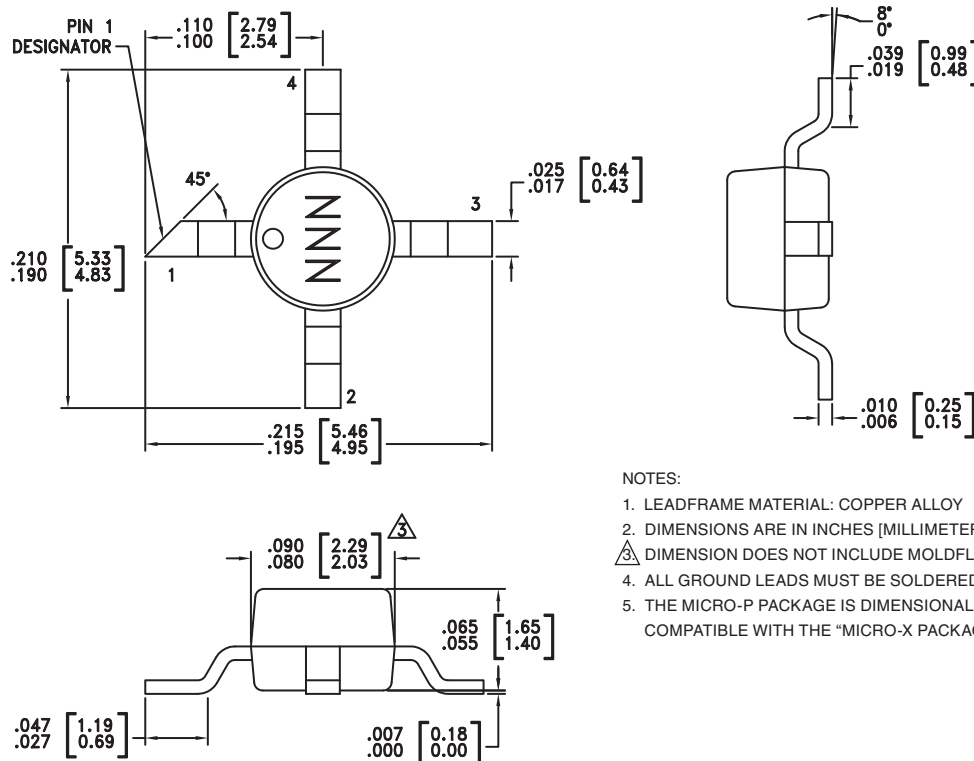
**ELECTROSTATIC SENSITIVE DEVICE
OBSERVE HANDLING PRECAUTIONS**
8
AMPLIFIERS - DRIVER & GAIN BLOCK - SMT
Outline Drawing

NOTES:

1. LEADFRAME MATERIAL: COPPER ALLOY
2. DIMENSIONS ARE IN INCHES [MILLIMETERS]
- △ DIMENSION DOES NOT INCLUDE MOLDFLASH OF 0.15mm PER SIDE.
4. ALL GROUND LEADS MUST BE SOLDERED TO PCB RF GROUND.
5. THE MICRO-P PACKAGE IS DIMENSIONALLY COMPATIBLE WITH THE "MICRO-X PACKAGE"

Package Information

Part Number	Package Body Material	Lead Finish	MSL Rating	Package Marking
HMC481MP86	Low Stress Injection Molded Plastic	Sn/Pb Solder	MSL1 ^[1]	481
HMC481MP86E	RoHS-compliant Low Stress Injection Molded Plastic	100% matte Sn	MSL1 ^[2]	481

[1] Max peak reflow temperature of 235 °C

[2] Max peak reflow temperature of 260 °C



Pin Descriptions

Pin Number	Function	Description	Interface Schematic
1	RFIN	This pin is DC coupled. An off chip DC blocking capacitor is required.	
3	RFOUT	RF output and DC Bias (Vcc) for the output stage.	
2, 4	GND	These pins must be connected to RF/DC ground.	

Application Circuit

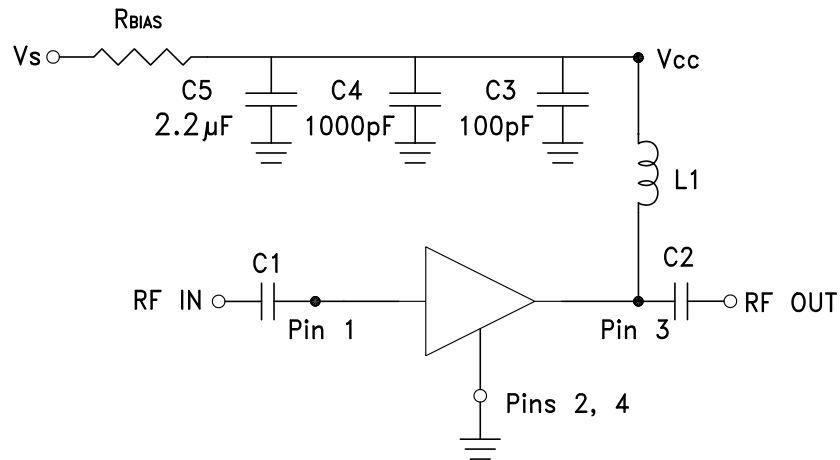

Recommended Bias Resistor Values for $I_{CC} = 74 \text{ mA}$, $R_{BIAS} = (V_s - V_{CC}) / I_{CC}$

Supply Voltage (Vs)	6V	8V	10V	12V
RBIAS VALUE	11 Ω	39 Ω	62 Ω	91 Ω
RBIAS POWER RATING	1/8 W	1/4 W	1/2 W	1 W

Note:

- External blocking capacitors are required on RFIN and RFOUT.
- RBIAS provides DC bias stability over temperature.

Recommended Component Values for Key Application Frequencies

Component	Frequency (MHz)						
	50	900	1900	2200	2400	3500	5000
L1	270 nH	56 nH	18 nH	18 nH	15 nH	8.2 nH	6.8 nH
C1, C2	0.01 μF	100 pF	100 pF	100 pF	100 pF	100 pF	100 pF



Evaluation PCB

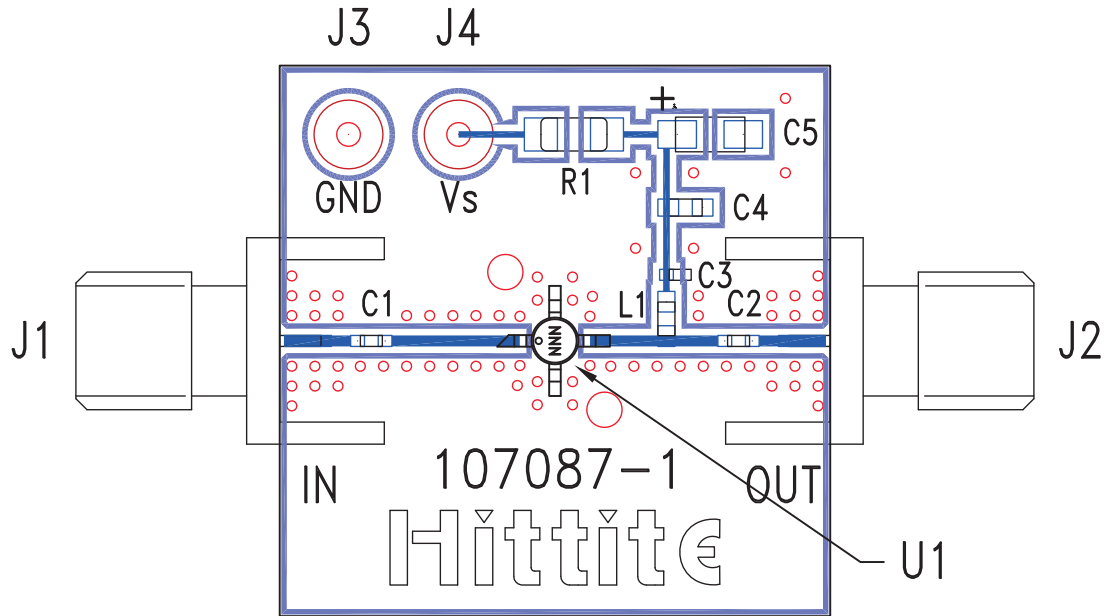

List of Materials for Evaluation PCB 107490 [1]

Item	Description
J1 - J2	PCB Mount SMA Connector
J3 - J4	DC Pin
C1, C2	Capacitor, 0402 Pkg.
C3	100 pF Capacitor, 0402 Pkg.
C4	1000 pF Capacitor, 0603 Pkg.
C5	2.2 μ F Capacitor, Tantalum
R1	Resistor, 1210 Pkg.
L1	Inductor, 0603 Pkg.
U1	HMC481MP86 / HMC481MP86E
PCB [2]	107087 Evaluation PCB

[1] Reference this number when ordering complete evaluation PCB

[2] Circuit Board Material: Rogers 4350

The circuit board used in the application should use RF circuit design techniques. Signal lines should have 50 Ohm impedance while the package ground leads should be connected directly to the ground plane similar to that shown. A sufficient number of via holes should be used to connect the top and bottom ground planes. The evaluation board should be mounted to an appropriate heat sink. The evaluation circuit board shown is available from Hittite upon request.