

NEW PRODUCT

# Bulletin

**PulseGuard®**

**Instant Protection**

**From ESD Threats**



**Given uncontrollable operating environments and costly equipment returns, the dilemma facing circuit designers today is not: Do I need to protect against ESD transients? Rather, the question is: What is the best available solution for ESD transient protection?**

The need for better ESD protection is evident with the changing characteristics of modern integrated circuitry. Physical geometries are

becoming more dense, operating voltages are decreasing, and operating speeds are increasing. All of these have contributed to the establishment of strict standards that must be met relative to ESD withstand capabilities (IEC 1000-4-2).

In response to these issues, Littelfuse introduces the PulseGuard suppressor line — providing the ultimate ESD protection for the sensitive integrated circuitry used in today's electronic equipment.



 **Littelfuse®**

WORLDWIDE LEADER IN  
CIRCUIT PROTECTION TECHNOLOGIES

## The Need for Better ESD Protection

The computer revolution has mandated the need for more and more communication links between electronic systems (computers, peripherals, etc.), causing an associated explosion in the magnitude of the data that must be handled. Data transmission rates, by necessity, have increased and will continue to increase.

Historically, transient voltage protection for electronic systems evolved with changing electronic technology. Prior to the use of solid state components, vacuum tubes were used as the building blocks of electronic systems. These devices exhibited substantial survivability to high voltage events such as ESD, indirect lightning, electrical fast transients (EFT), and system-generated transients. The need for additional protection devices was low. However, as transistors became the building blocks of electronic systems, equipment such as modern data processing equipment became increasingly vulnerable to common ESD events.

This increased sensitivity of electronic systems can be correlated to the decreasing size of their circuitry. Simply put, as the physical geometry of the circuitry decreased, so too did the amount of energy needed to destroy the circuit's components (e.g., transistors, interconnects, insulators, etc.). As a result, the need for a new generation of products to protect extremely vulnerable circuitry has never been greater.

While electronic components were evolving toward their current state, a similar progression was taking place with electronic signals and the methods of information transmission. This has resulted in increased signal bandwidths, higher data transmission rates, and more complex signal waveforms. In order to maintain the integrity of these data transmissions, it is vital for new circuit protection devices to remain electrically transparent by not interfering with, or degrading, the signals.

The first generation of transient protection products was designed to mitigate the effects of the direct lightning threat. However, the source of today's high voltage transients has expanded beyond lightning to include such threats as electrostatic discharge (ESD) and electrical fast transients (EFT). Correspondingly, the parameters of the new threats have changed as well. For example, the current and voltage rise time of lightning transients are orders of magnitude slower than those experienced during electrostatic discharge.

***The fundamental question which now needs to be asked is:*** Can the circuit protection devices of the past provide optimal protection for the circuits of today?

## The Littelfuse Solution

The PulseGuard® suppressor line from Littelfuse employs a voltage variable material (VVM) that has a non-linear resistivity response to voltage (see Figure 1). While the circuit is operating normally, the ESD suppressor is electrically transparent. When an ESD event occurs, the VVM becomes conductive, shunting the ESD energy away from the circuitry. After the ESD energy has been dissipated, the suppressor returns to a consistent high off-state resistance.

PulseGuard suppressors also offer very low capacitance, assuring they will not cause degradation to, or attenuation of, data signals. This is vital given they will primarily be protecting high-speed digital data lines. Typical effects of higher capacitance when protecting with alternate technologies include distortion of the digital waveform, as seen in Figure 3.



## Resistance vs. Voltage

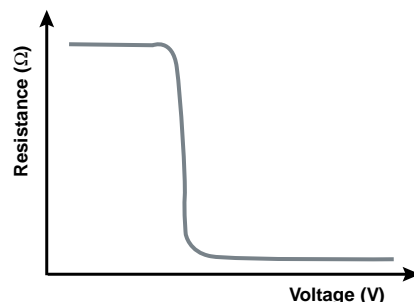
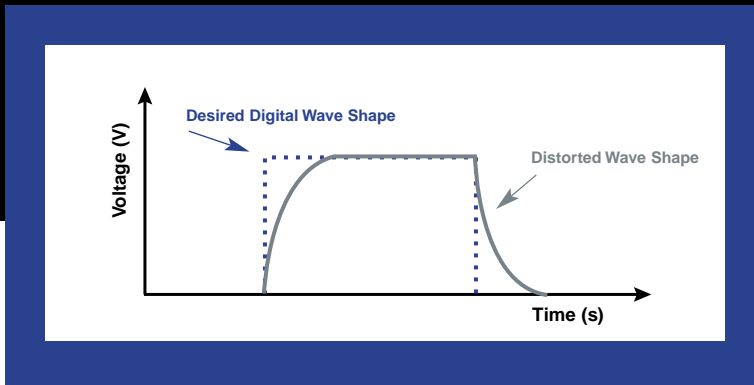

Figure 1:  
PulseGuard  
Suppressor  
Response Curve

**Figure 3:**  
Digital Waveform  
Distortion due  
to Capacitance



When considering the use of ESD protection components, it is important that lead inductance be taken into account. Given the fast rise time of typical ESD events, high frequency design rules must be applied. The length of wire leads and printed circuit board traces must be minimized to reduce inductive isolation of the ESD suppressor and chassis ground. Also, suppression components constructed with lead frames and wire bonds can allow induced voltages to be experienced by the protected circuitry due to package inductance.

By using a polymer VVM, Littelfuse is able to offer PulseGuard® suppressors in a wide range of sizes and configurations, each optimized to your specific design needs. Ideally, we recommend our connector-based products to effectively create a “leadless” installation. The ESD pulse is simply shunted to chassis ground at the outside of the equipment case. Connector configurations are also suitable in applications where board space is at a premium, or where an ESD problem was not identified until after the board design had been completed. In this case, using an ESD suppressor package that is incorporated at the connector can eliminate costly and time consuming re-design work.

If the connector configuration is not a viable packaging option, Littelfuse also offers a wide variety of surface-mount PulseGuard suppressors. These range from single-line devices to multiple-line arrays. The products can also be made to fit industry standard footprints or customized to meet your specific needs. For example, the array devices can be made to fit the SOT23 outline for applications requiring two lines of protection or the S08 outline for applications requiring 7 lines of protection. Smaller non-standard outlines may be manufactured to save board space.

Once again, it is important to remember discrete and array PulseGuard suppressors should be installed as close to the source of ESD (edge of the board) as possible. Since they are leadless components and do not employ leadframes or wirebonds, their contribution to voltage “overshoot” is minimized.

### Key PulseGuard Features

- Bi-directional
- Fastest response time, less than 1 nanosecond
- Lowest capacitance, less than 1 picofarad
- Clamping voltage, sufficiently low for ESD energy levels
- 24 VDC rating
- Wide range of configurations (board level and connector-based components)
- Low inductance packages

- Flat frequency response from 1Hz to 1GHz; Cut-off frequency (3dB point) is about 3GHz (Assumes 150Ω source resistance)
- Allows equipment compliance to ESD specifications (IEC 1000-4-2, MIL-STD 883)
- Durable design; withstands >10,000 pulses without degradation

*NOTE: When specifying ESD protection devices, it is important to specify an ESD test waveform. Because rise times for ESD events are orders of magnitude faster (sub-nanosecond vs. microsecond) than for other overvoltage events (lightning, line surge, etc.), the suppressors responses are not the same.*

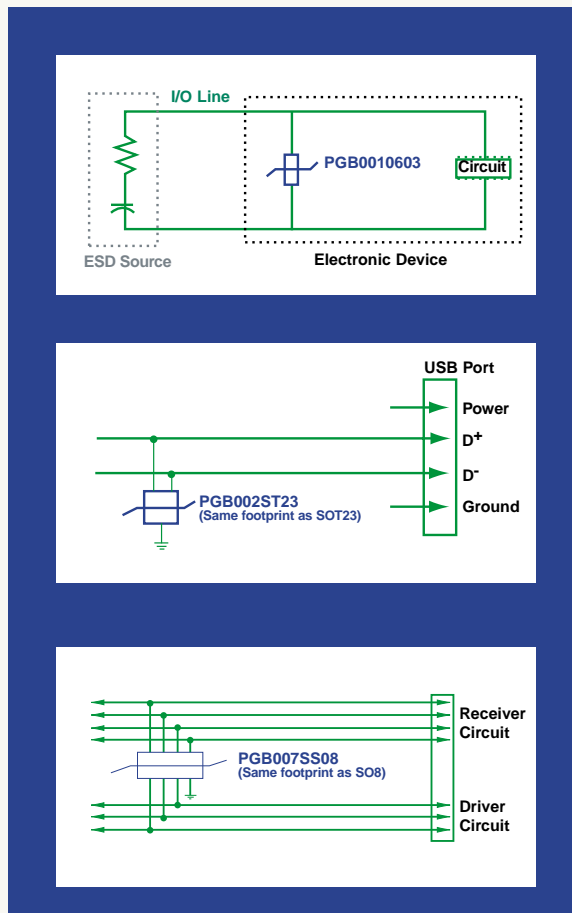

**Figure 4:**  
Protection of  
Audio Line  
With PulseGuard  
Single-Line Suppressor  
(PGB0010603)

**Figure 5:**  
Protection of  
USB Data Lines  
With PulseGuard  
Two-Line Suppressor  
(PGB002ST23)

**Figure 6:**  
Protection of  
RS-232 Port  
With PulseGuard  
Seven-Line Suppressor  
(PGB007SS08)

*PulseGuard suppressors should always be installed as close to the ESD source as possible.*

**Figure 7:**  
IEC 1000-4-2  
Contact Discharge  
Test Specifications

## Typical Applications

There are a variety of circuits that require protection from the effects of ESD events. Examples include: video, mouse, keyboard, and I/O computer ports; printer and network ports; audio components; communication ports on business machines; and other products which rely on sensitive ICs.

Figures 4, 5 and 6 illustrate the use of PulseGuard® suppressors in three typical applications. Figure 4 shows protection of a single communications line. Figure 5 illustrates protection of the data lines of a USB port. Finally, Figure 6 details how a PulseGuard suppressor can be configured to protect the driver/receiver lines of an RS-232 port. Refer to the Selection Guide for a wide variety of application examples and a listing of recommended Littelfuse products for each.

## What is IEC 1000-4-2?

As previously mentioned, one of the factors used to define the need for better ESD protection is a more demanding standard being used to determine the susceptibility of equipment to damage by ESD. This important specification is IEC 1000-4-2. Alternatively, it can be referred to as EN61000-4-2.

Created by the International Electrotechnical Commission (IEC), the 1000-4-2 specification provides the definition of the ESD waveform, energy levels, and the methodologies that are used to test the ability of electronic equipment to survive multiple, severe ESD events. The ESD waveform and test severity levels (for contact discharge) defined in 1000-4-2 are shown in Figure 7. There are specifications for an air-discharge test but contact discharge is the preferred test methodology due to reproducibility of the procedure.

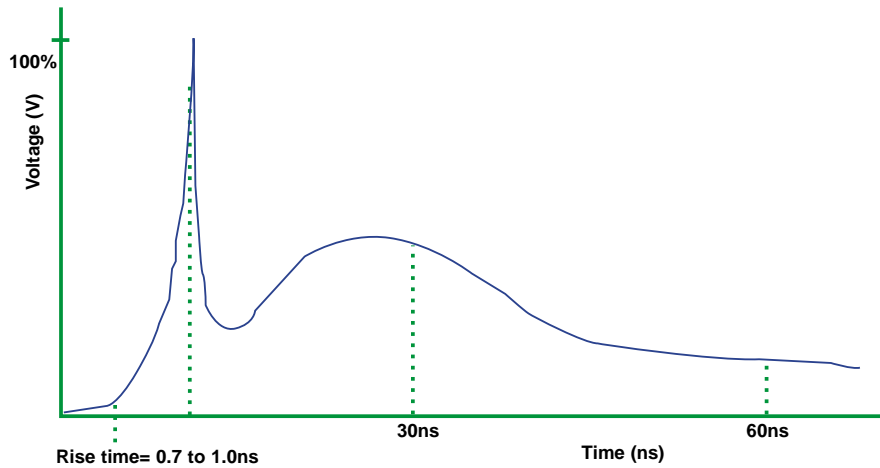

Severity Level	Discharge Voltage	Initial Current	30ns Current	60ns Current
1	2kV	7.5A	4A	2A
2	4kV	15A	8A	4A
3	6kV	22.5A	12A	6A
4	8kV	30A	16A	8A

This test specification provides the means for test engineers to inject repeatable test pulses into the Equipment-Under-Test (EUT) and evaluate it in terms of ESD survivability. As Figure 7 illustrates, there are various severity levels that can be used to define the EUT's immunity against ESD.

Regardless of the severity level chosen, the ESD pulses are to be injected at locations that are accessible to users during normal operation and maintenance of the EUT. The test is performed as a series of ten pulses, applied in the polarity that the EUT is most sensitive to. If the EUT is able to perform without permanent damage or electronic upset during and after the series of test pulses, the EUT is said to have passed the respective level of IEC 1000-4-2 testing.

Currently, electronic equipment manufacturers are required to certify that their equipment can survive testing to the IEC standard if they are selling that equipment into the European Union. The sale of electronic equipment that cannot meet the 1000-4-2 testing is considered a prosecutable offense

in that market. Compliance is voluntary in the United States at this time.

As the leader in circuit protection technology, Littelfuse is introducing the connector configuration and surface mount families of PulseGuard ESD suppressors to assist customers in complying with all severity levels of IEC 1000-4-2 testing. By providing full ESD suppression functionality and by remaining electrically transparent to the circuit that they are protecting, PulseGuard ESD suppressors offer optimal protection for your products.

# SELECTION GUIDE

APPLICATION	PROTECTION	LITTELFUSE PRODUCT
<b>USB and IEEE 1394</b>	Protection is supplied to the data lines (D <sup>+</sup> and D <sup>-</sup> ) of the USB and IEEE 1394 data ports.	PGB002ST23
<b>RS-232 Ports</b>	Protection is supplied to the driver and receiver lines.	PGB007SS08, DSUB 9 Connector Array
<b>Parallel Ports</b>	Protection for the data lines.	DSUB 25 Connector Array
<b>Keyboard and Mouse Ports</b>	Protection is supplied to the data and clock lines.	PGB0010603, PGB002ST23
<b>Video Ports</b>	Protection for the digital signal lines.	PGB007SS08, PGB0010603
<b>Network Routers</b>	Protection for the data lines.	RJ Connector Array
<b>Alarm and Security Circuits</b>	Protection is supplied on signal lines.	PGB0010603, PGB002ST23
<b>Medical and Test Equipment</b>	Protection for the probe lines.	Connector Array or Surface Mount Component with the appropriate number of lines

## INTRODUCING

# PulseGuard<sup>®</sup> ESD Suppressors

Introducing the next generation in transient voltage circuit protection devices. Beginning with the PulseGuard suppressor line, Littelfuse offers a polymer-based, optimal solution for ESD events.

With quick response time (<1.0ns) and high current handling capabilities (45A at 15kV), PulseGuard suppressors provide protection against multiple severe ESD events (>10,000 pulses). They exhibit low capacitance (<1.0pF) and low leakage current (<0.1µA) which are an order of magnitude lower than previous solutions. This means they are electrically transparent to the protected circuit and as THE IDEAL solution, they will not degrade or attenuate the data or control signals on the lines they are protecting.

The Littelfuse PulseGuard line of ESD protection products is ideal for the sensitive integrated circuitry driving today's electronic equipment. Examples of PulseGuard suppressor applications can be found in the adjacent Selection Guide, and typical ESD protection points within a computer network are detailed in Figure 2.

A significant benefit of using a polymer-based solution can be seen in the wide range of form factors available to the circuit designer. Device configurations include a discrete (single line) component, multi-line arrays, and connector-based configurations. The discrete and array packages are available in surface-mount configurations, providing a perfect fit for today's board manufacturing techniques.

Figure 2:  
ESD Gateways  
and PulseGuard  
Protection within  
Computer Network

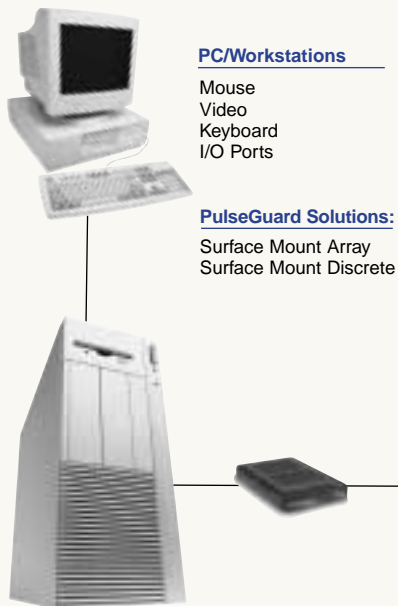

### Peripherals

Router  
 Printer  
 Scanner

### PulseGuard Solutions:

Connector Array  
 Surface Mount Array

## Physical Specifications

### Materials:

#### Surface Mount Packages

**Body Material:** Glass epoxy

**Terminations:** Copper/nickel/tin-lead

**Voltage Variable Material:**

Littelfuse polymeric formula

#### Connector Configurations

**Body Material:** Polyimide

**Terminations:** Spring contacts

**Voltage Variable Material:**

Littelfuse polymeric formula

### Soldering Parameters:

#### Surface Mount Packages

**Wave Solder:** 260°C, 10 seconds maximum

**Reflow Solder:** 260°C, 30 seconds maximum

#### Connector Configurations

**Press-in fitting:** soldering not necessary

### Packaging:

**Surface Mount:** Tape and reel per EIA-RS481

**Connector:** Bulk, bagged and tagged

### Environmental Specifications:

**Operating Temperature:** -65°C to 125°C

**Vibration:** Withstands 10-55Hz per MIL-STD-202F, Method 201A and 10-2000Hz at 20Gs per MIL-STD-202F, Method 204D, Condition D.

**Insulation Resistance (off-state):**

Min. 500,000Ω at 30VDC typically >10MΩ

**Thermal Shock:** Withstands 5 cycles of

-50°C to +125°C

### Littelfuse, Inc.

800 E. Northwest Highway  
Des Plaines, IL 60016

Phone: **847-824-0400**

Technical Assistance: **800-999-9445**

Fax: **847-824-3024**

Internet: **www.littelfuse.com**

E-Mail: **electronics@littelfuse.com**

### Dimensional Drawings:

PGD009S03CSF01



PGD015S030CSF01



PGD025S030CSF01

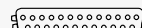

PGD037S030CSF01

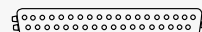

PGD050S030CSF01

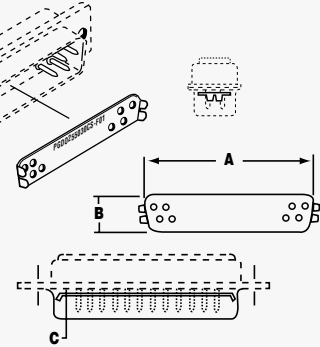
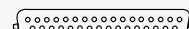

# of Contacts (20 GA.)	Part Number	A	B	C
9	PGD009S030CSF01	.65	.324	.015 Max
15	PGD015S030CSF01	.98	.324	.015 Max
25	PGD025S030CSF01	1.52	.324	.015 Max
37	PGD037S030CSF01	2.17	.324	.015 Max
50	PGD050S030CSF01	2.06	.436	.015 Max

Alternate mountings and configurations available. Contact Littelfuse for details.

### Reference Dimensions:

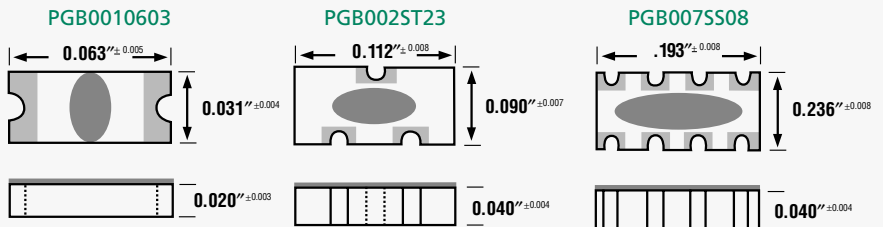

### Recommended Pad Layouts:

PGB0010603			PGB002ST23			PGB007SS08		
Reference	Dimension (in.)		Reference	Dimension (in.)		Reference	Dimension (in.)	
a	Reflow	0.030	Wave	0.043	a	Reflow	0.030	0.043
b	0.043	0.043	b	0.043	0.043	b	0.043	0.043
c	0.040	0.040	c	0.060	0.047	c	0.206	0.193
d	n/a	n/a	d	0.075	0.075	d	0.050	0.050
e	0.100	0.126	e	0.120	0.133	e	0.266	0.279

Specifications are subject to change without prior notice